

MiniDisc Deck

Operating Instructions



MDS-S41

WARNING

To prevent fire or shock hazard, do not expose the unit to rain or moisture.

To avoid electrical shock, do not open the cabinet. Refer servicing to qualified personnel only.

This appliance is classified as a CLASS 1 LASER product.

The CLASS 1 LASER PRODUCT MARKING is located on the rear exterior.

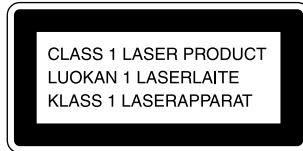

IN NO EVENT SHALL SELLER BE LIABLE FOR ANY DIRECT, INCIDENTAL OR CONSEQUENTIAL DAMAGES OF ANY NATURE, OR LOSSES OR EXPENSES RESULTING FROM ANY DEFECTIVE PRODUCT OR THE USE OF ANY PRODUCT.

For the customers in the U.S.A.

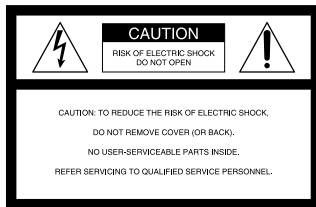

This symbol is intended to alert the user to the presence of uninsulated “dangerous voltage” within the product’s enclosure that may be of sufficient magnitude to constitute a risk of electric shock to persons.



This symbol is intended to alert the user to the presence of important operating and maintenance (servicing) instructions in the literature accompanying the appliance.

INFORMATION

This equipment has been tested and found to comply with the limits for a Class B digital device, pursuant to Part 15 of the FCC Rules. These limits are designed to provide reasonable protection against harmful interference in a residential installation. This equipment generates, uses, and can radiate radio frequency energy and, if not installed and used in accordance with the instructions, may cause harmful interference to radio communications. However, there is no guarantee that interference will not occur in a particular installation. If this equipment does cause harmful interference to radio or television reception, which can be determined by turning the equipment off and on, the user is encouraged to try to correct the interference by one or more of the following measures:

- Reorient or relocate the receiving antenna.
- Increase the separation between the equipment and receiver.
- Connect the equipment into an outlet on a circuit different from that to which the receiver is connected.
- Consult the dealer or an experienced radio/TV technician for help.

CAUTION

You are cautioned that any changes or modification not expressly approved in this manual could void your authority to operate this equipment.

Owner’s Record

The model and serial numbers are located on the rear of the unit. Record the serial number in the space provided below. Refer to them whenever you call upon your Sony dealer regarding this product.

Model No. MDS-S41

Serial No. _____

For the customers in Canada

CAUTION

TO PREVENT ELECTRIC SHOCK, DO NOT USE THIS POLARIZED AC PLUG WITH AN EXTENSION CORD, RECEPTACLE OR OTHER OUTLET UNLESS THE BLADES CAN BE FULLY INSERTED TO PREVENT BLADE EXPOSURE.

Welcome!

Thank you for purchasing the Sony MiniDisc Deck. Before operating the deck, please read this manual thoroughly and retain it for future reference.

About This Manual

The instructions in this manual are for the MDS-S41 MiniDisc Deck.

Conventions

- Controls in these instructions are those on the deck; these may, however, be substituted by controls on the supplied remote that are similarly named, or, when different, appear in the instructions within parentheses.

Example: Turn AMS clockwise (or press ►► repeatedly).

- The following icons are used in this manual:

Indicates a procedure that requires use of the remote.

Indicates hints and tips for making the task easier.

TABLE OF CONTENTS

Getting Started 4

- Before You Start the Hookup 4
- Hooking Up the Audio Components 5

Location and Function of Parts 8

- Front Panel Parts Description 8
- Remote Parts Description 10
- Using the Display 11

Recording on MDs 13

- Notes on Recording 13
- Recording on an MD 14
- Adjusting the Recording Level 16
- Recording Tips 16
- Marking Track Numbers While Recording (Track Marking) 17
- Starting Recording With Six Seconds of Prestored Audio Data (Time Machine Recording) 18
- Synchro-recording With the Audio Component of Your Choice (Music Synchro-recording) 19
- Synchro-recording With a Sony CD Player (CD Synchro-recording) 19

Playing MDs 21

- Playing an MD 21
- Playing a Specific Track 22
- Locating a Particular Point in a Track 23
- Playing Tracks Repeatedly 23
- Playing Tracks in Random Order (Shuffle Play) 24
- Creating Your Own Program (Program Play) 25
- Tips for Recording From MDs to Tape 26

Editing Recorded MDs 28

- Erasing Tracks 29
- Dividing Tracks 31
- Combining Tracks 32
- Moving Tracks 32
- Naming a Track or MD 33
- Undoing the Last Edit 36

Other Functions 37

- Fade In and Fade Out 37
- Falling Asleep to Music (Sleep Timer) 38

Additional Information 39

- Precautions 39
- Handling MDs 40
- System Limitations 40
- Troubleshooting 41
- Specifications 41
- Display Messages 42
- Edit Menu Table 43
- Setup Menu Table 44
- Self-Diagnosis Function 44
- Using the Beeps 45
- Index 46

Getting Started

This chapter provides information on the supplied accessories, things you should keep in mind while hooking up the system, and how to connect various audio components to the MD deck. Be sure to read this chapter thoroughly before you actually connect anything to the deck.

Before You Start the Hookup

Checking the supplied accessories

This MD deck comes with the following items:

- Audio connecting cords (2)
- Optical cable (1)
- Remote commander (remote) RM-D29M (1)
- R6 (size-AA) batteries (2)

Inserting batteries into the remote

Insert two R6 (size-AA) batteries with the + and – properly oriented to the markings into the battery compartment. When using the remote, point it at the remote sensor  on the deck.

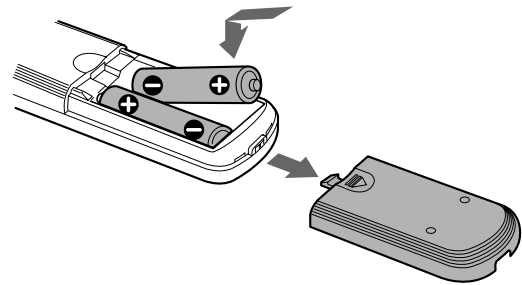

When to replace the batteries

Under normal conditions, the batteries should last for about six months. When the remote no longer operates the deck, replace both batteries with new ones.

Notes

- Do not leave the remote in an extremely hot or humid place.
- Do not drop any foreign object into the remote casing, particularly when replacing the batteries.
- Do not use a new battery with an old one.
- Do not expose the remote sensor to direct sunlight or lighting apparatus. Doing so may cause a malfunction.
- If you don't use the remote for an extended period of time, remove the batteries to avoid possible damage from battery leakage and corrosion.

Hooking Up the Audio Components

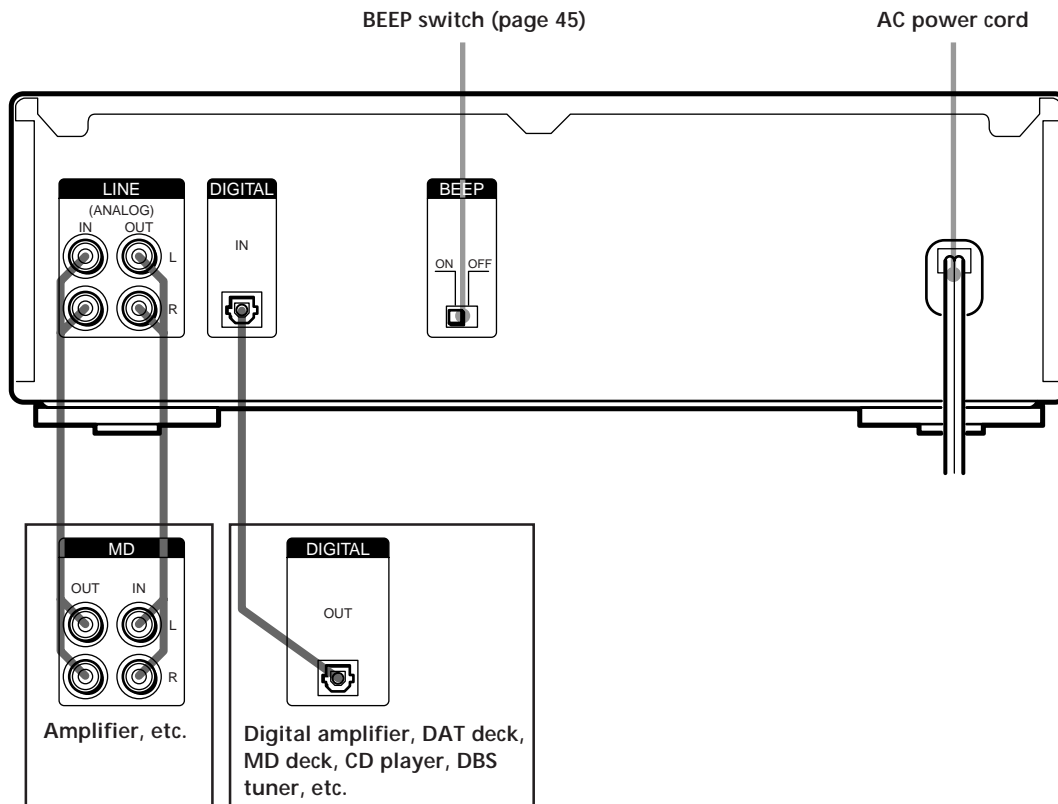

Required cords

Audio connecting cords (2) (supplied)

When connecting an audio connecting cord, be sure to match the color-coded pins to the appropriate jacks: white (left) to white and red (right) to red.

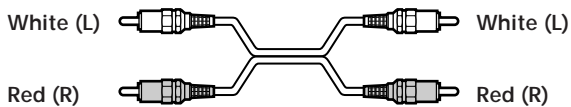

Optical cable (1) (supplied)

- When connecting an optical cable, take the caps off the connectors and insert the cable plugs straight in until they click into place.
- Do not bend or tie the optical cable.

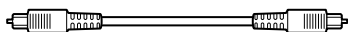

Things you should keep in mind while hooking up the system

- Turn off the power to all components before making any connections.
- Do not connect any AC power cord until all the connections are completed.
- Be sure the connections are firm to prevent hum and noise.

Jacks (connectors) for connecting audio components

Connect	To the
Amplifiers	LINE (ANALOG) IN/OUT jacks
Digital amplifiers, DAT decks, another MD deck, CD players, or DBS tuners	DIGITAL IN connector

Hooking Up the Audio Components

Setting the voltage (only on models supplied with a voltage selector)

Make sure the voltage selector on the rear panel of the deck is set to the voltage of the local power supply. If not, use a screwdriver to change it to the correct position before connecting the AC power cord to a wall outlet.

Example

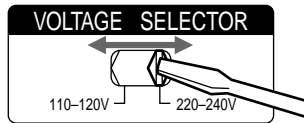

Connecting the AC power cord

Connect the AC power cord of the deck to a wall outlet.

Note

Do not connect the AC power cord to a switched outlet.

Location and Function of Parts





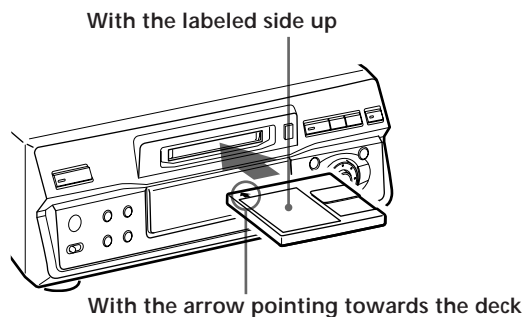

This chapter tells you about the location and function of the various buttons and controls on the front panel and the supplied remote. Further details are provided on the pages indicated in the parentheses. It also tells you about the information that appears in the display window.

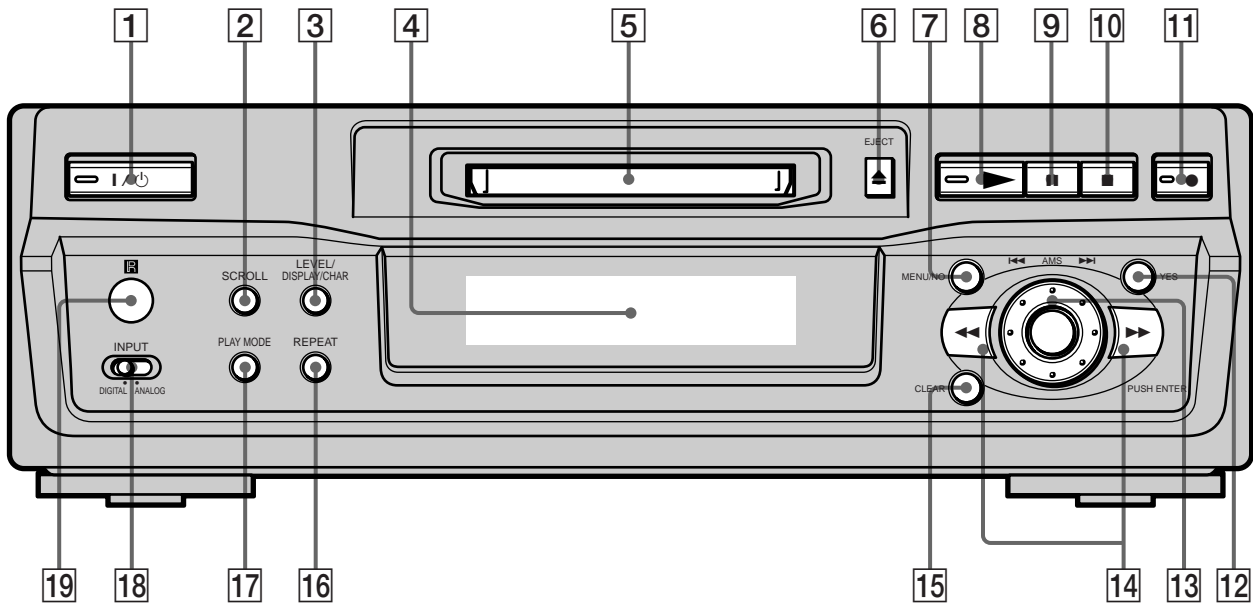
Front Panel Parts Description

- 1 I/⏻ (power) switch (14, 21)
Press to turn the deck on. When you turn the deck on, the switch indicator turns off. When you press the switch again, the deck turns off and the indicator lights up red.
- 2 SCROLL button (12)
Press to scroll the name of a track or MD.
- 3 LEVEL/DISPLAY/CHAR button (12, 16, 25, 33)
 - Press during recording or recording pause to adjust the recording level.
 - Press when the deck is stopped to display disc information or the contents of a program.
 - Press during recording to display information on the track being recorded.
 - Press during play to display information on the current track.
 - Press while editing an MD to select the type of characters to be input.
- 4 Display window (11, 12)
Shows various information.
- 5 MD insertion slot (14, 21)
Insert the MD as illustrated below.





- 6** EJECT  button (15, 21)
Press to eject the MD.
- 7** MENU/NO button (14, 29, 38)
Press to display “Edit Menu” or “Setup Menu.”
- 8**  button (15, 21)
Press to start play.
- 9**  button (15, 21)
Press to pause play or recording. Press again to resume play or recording.
- 10**  button (15, 21, 29)
Press to stop play, stop recording, or cancel the selected operation.
- 11**  button (15-17)
Press to record on the MD, monitor the input signal, or mark track numbers.
- 12** YES button (14, 25, 29, 38)
Press to carry out the selected operation.
- 13** AMS control (14-16, 21, 25, 29, 33, 38)
Turn to locate tracks, adjust the recording level, select the input characters, or select a menu item.
- 14**  buttons (23, 25, 30, 33)
Press to locate a portion within a track, change the contents of a program, or change the input character.
- 15** CLEAR button (26, 34)
Press to cancel the selection.
- 16** REPEAT button (23, 24)
Press to play tracks repeatedly.
- 17** PLAY MODE button (24)
Press to select Shuffle Play or Program Play.
- 18** INPUT switch (14)
Use to select the input jack (or connector) of the program source to be recorded.
- 19** Remote sensor (4)
Point the remote towards this window () for remote operations.

Remote Parts Description

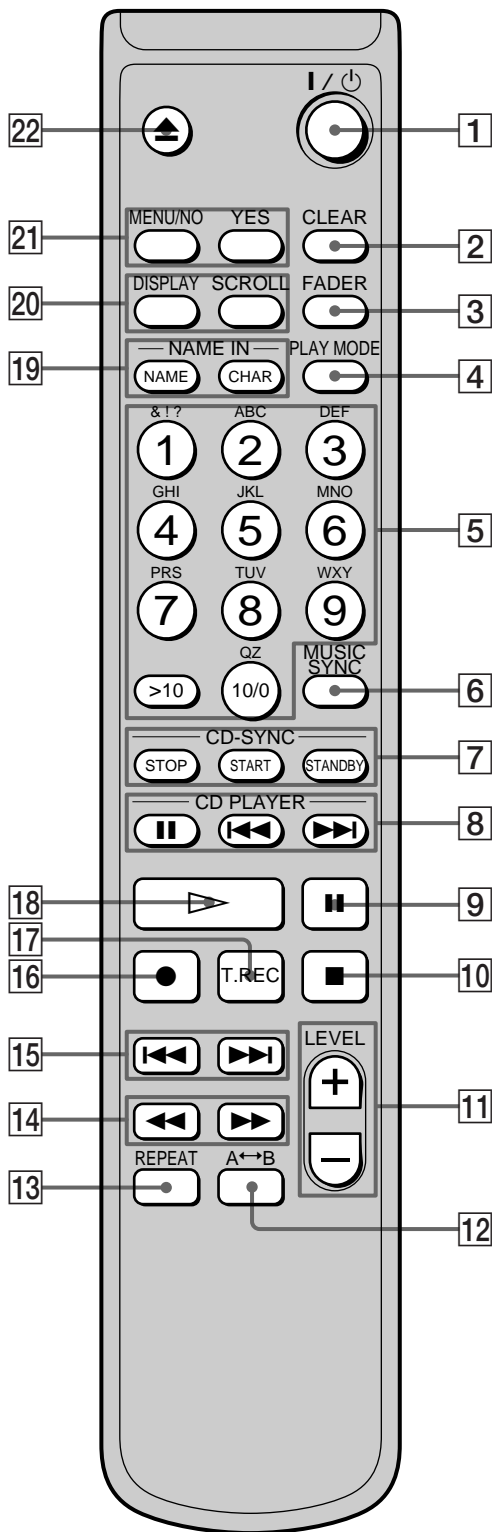

- 1** I/⏻ (power) switch (14, 21)
Press to turn the deck on. When you turn the deck on, the I/⏻ switch indicator on the deck turns off. When you press the switch again, the deck turns off and the indicator lights up red.
- 2** CLEAR button (26, 34)
Press to cancel the selection.
- 3** FADER button (37)
Press to perform Fade-in Play/Recording or Fade-out Play/Recording.
- 4** PLAY MODE button (24)
Press to select Shuffle Play or Program Play.
- 5** Letter/number buttons (22, 34)
Press to enter a track number directly or input letters or numbers.
- 6** MUSIC SYNC button (19)
Press to start Music Synchro-recording.
- 7** CD-SYNC STOP button (20)
Press to stop CD Synchro-recording.
CD-SYNC START button (19)
Press to start CD Synchro-recording.
CD-SYNC STANDBY button (19)
Press to enter standby for CD Synchro-recording.
- 8** CD PLAYER ⏸ button (20)
Press to pause the CD play. Press again to resume CD play.
CD PLAYER ⏮/⏭ buttons (20)
Press to locate tracks on the CD.
- 9** ⏸ button (15, 21)
Press to pause play or recording. Press again to resume play or recording.
- 10** ■ button (15, 21, 29)
Press to stop play, stop recording, or cancel the selected operation.
- 11** LEVEL +/- buttons (16)
Press to adjust the recording level.
- 12** A↔B button (24)
Press to select Repeat A-B Play.
- 13** REPEAT button (23, 24)
Press to play tracks repeatedly.
- 14** ⏮/⏭ buttons (23, 25, 30, 34)
Press to locate a portion within a track, change the contents of a program, or shift the cursor to the right.

- 15** **◀◀/▶▶** buttons (14-16, 21, 25, 29, 34, 38)
Press to locate tracks, adjust the recording level, or select a menu item.
- 16** **●** button (15-17)
Press to record on the MD, monitor the input signal, or mark track numbers.
- 17** **T.REC** button (18)
Press during recording pause to start Time Machine Recording.
- 18** **▷** button (15, 21)
Press to start play.
- 19** **NAME** button (34)
Press to add the name or change the name of a track or MD.
- CHAR** button (34)
Press to select the type of characters to be input when naming a track or MD.
- 20** **DISPLAY** button (12, 16, 25)
Press to select the information to be displayed in the window.
- SCROLL** button (12)
Press to scroll the name of a track or MD.
- 21** **MENU/NO** button (14, 29, 38)
Press to display "Edit Menu" or "Setup Menu."
- YES** button (14, 25, 29, 38)
Press to carry out the selected operation.
- 22** **▲** button (15, 21)
Press to eject the MD.

Using the Display

The display window shows information about the MD or track. This section describes the information that appears for each deck status.

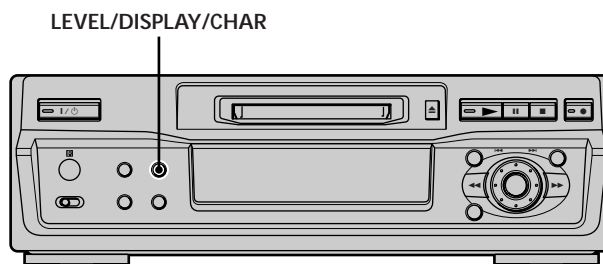

Note

The type of information (e.g., total number of tracks, recorded time, remaining time, track or disc name) which was last displayed will continue to appear until you change it by pressing LEVEL/DISPLAY/CHAR (or DISPLAY), even if you change the deck operation status. For example, if the remaining time was displayed when you stop the deck, the remaining time will continue to appear when you begin playing the same MD again or a different one.

When you insert an MD

The display automatically changes as follows:

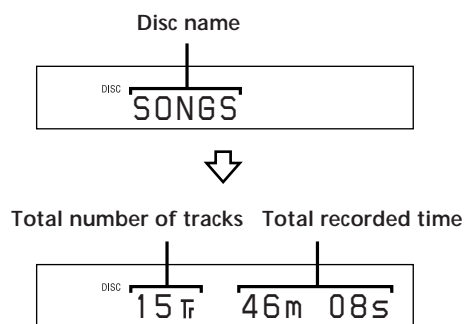

Using the Display

While the deck is stopped

Press LEVEL/DISPLAY/CHAR (or DISPLAY) repeatedly to change the display.

Each press of the button changes the display as follows:

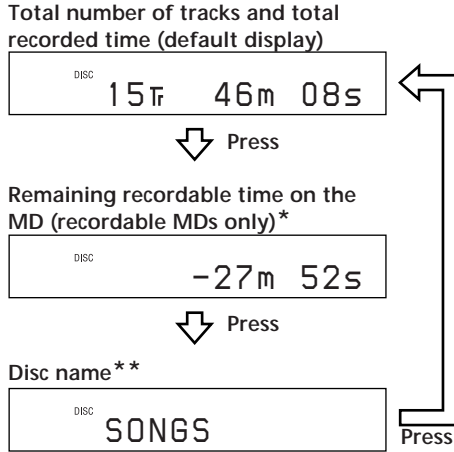

* Not shown for the premastered discs.

**When the MD has no name, "No Name" appears, followed by the default display.

While the deck is recording

Press LEVEL/DISPLAY/CHAR (or DISPLAY) repeatedly to change the display.

Each press of the button changes the display as follows:

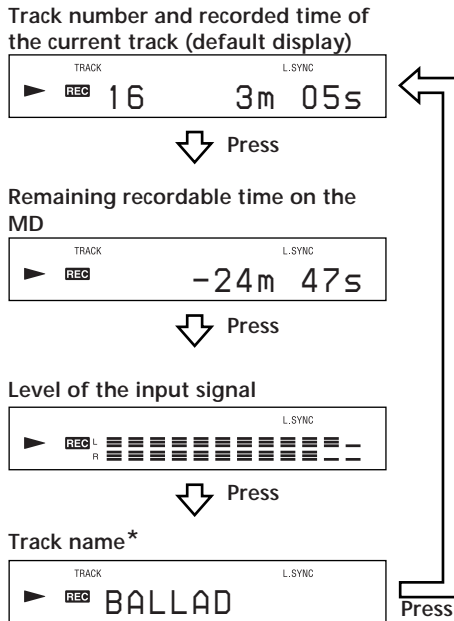

* When the track has no name, "No Name" appears, followed by the default display.

While the deck is playing

Press LEVEL/DISPLAY/CHAR (or DISPLAY) repeatedly to change the display.

Each press of the button changes the display as follows:

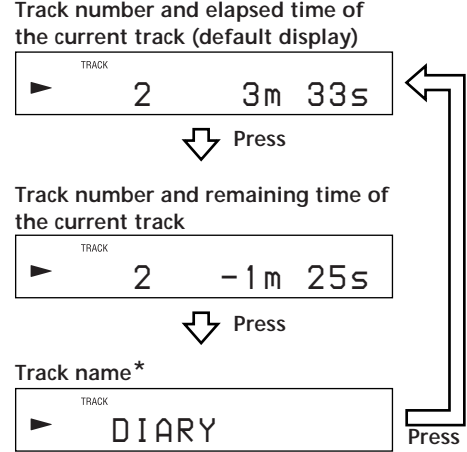

* When the track has no name, "No Name" appears, followed by the default display.

You can check the track name at any time while playing. Press SCROLL.

The track name appears and scrolls. While the track name is scrolling, press the button again to pause scrolling, and again to continue scrolling.

Recording on MDs

This chapter explains the various ways to record to an MD, as well as how to mark track numbers and perform synchro-recording with other components.

Notes on Recording

About indications which appear while recording

When “Protected” and “C11” alternate in the display

The record-protect slot is open and the MD is record-protected. To record on the MD, slide the tab to close the slot. For details, see “To prevent accidental erasure of the recorded material” on page 15.

When “Din Unlock” and “C71” alternate in the display

- The digital component selected with the INPUT switch is not connected correctly. Check the connection.
- The selected digital component is not turned on. Turn on the component.

When “Cannot Copy” appears in the display

The MD deck uses the Serial Copy Management System. MDs recorded through the digital input connector can't be copied to other MDs or DAT tapes through the digital output connector. For details, see “Guide to the Serial Copy Management System” on page 14.

When “TRACK” flashes in the display

The MD deck is recording over existing track(s) (“Recording on an MD” on page 14). The indication stops flashing when the deck reaches the end of the recorded portion.

About indications which appear after recording

When “TOC” lights up in the display

Recording has finished but the TOC (Table of Contents) on the MD has not been updated to reflect the recording results. The recording will be lost if you disconnect the AC power cord while the indication is on. The TOC will be updated only when you eject the MD or turn off the MD deck.

When “TOC Writing” flashes in the display

The deck is updating the TOC. Do not disconnect the AC power cord or move the deck while the indication flashes.

Notes on Recording

Automatic conversion of digital sampling rates during recording

A built-in sampling rate converter automatically converts the sampling frequency of various digital sources to the 44.1 kHz sampling rate of the MD deck. This allows you to monitor and record sources such as 32- or 48-kHz DAT tapes or satellite broadcasts, as well as the CDs and MDs.

Automatic de-emphasizing of input signals for digital recording

When recording digital input signals that have been emphasized in higher frequencies, the deck automatically de-emphasizes the signals with attenuation proportional to the degree of emphasis. The level of the de-emphasized signal is indicated on the peak level meters.

Guide to the Serial Copy Management System

Digital audio components, such as CDs, MDs, and DATs make it easy to produce high-quality copies of music by processing music as a digital signal. To protect copyrighted music sources, this deck uses the Serial Copy Management System which allows you to make only a single copy of a digitally recorded source through digital-to-digital connections.

You can make only a first-generation copy* through a digital-to-digital connection.

Examples are given as follows:

- You can make a copy of a commercially available digital sound program (for example, a CD or MD), but you can't make a second copy from the first-generation copy.
- You can make a copy of a digital signal from a digitally recorded analog sound program (for example, an analog record or a music cassette tape) or from a digital satellite broadcast program, but you can't make a second copy from the first-generation copy.

* A first-generation copy means the first recording of a digital audio source through the deck's digital input connector. For example, if you record from a CD player connected to the DIGITAL IN connector, that copy is a first-generation copy.

Note

The restrictions of the Serial Copy Management System don't apply when you make a recording through the analog-to-analog connections.

Recording on an MD

The operations for normal recording are explained below. If the MD has recorded material on it, the deck will automatically start recording from the end of the recorded portion.

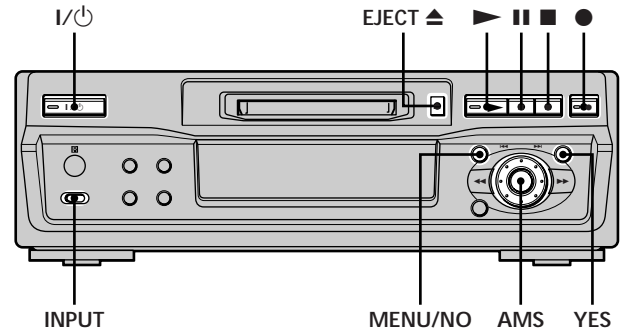

- 1 Turn on the amplifier and program source, and select the source on the amplifier.
- 2 Press I/⏻ to turn on the deck. The switch indicator turns off.
- 3 Insert a recordable MD.
- 4 Set INPUT to the position that corresponds to the input jacks (connector) connected to the program source.

If the source is connected to the	Set INPUT to
DIGITAL IN connector	DIGITAL
LINE (ANALOG) IN jacks	ANALOG

- 5 Press MENU/NO twice. "Set Menu" appears in the display.
- 6 Turn AMS (or press ◀◀/▶▶ repeatedly) until "Stereo Rec" or "Mono Rec" appears in the display, then press AMS or YES.
- 7 Turn AMS (or press ◀◀/▶▶ repeatedly) to select the recording mode, then press AMS or YES.

To record in	Select
Stereo	Stereo Rec (factory setting)
Monaural	Mono Rec

Monaural mode allows you to record about twice as much material as stereo.

- 8 Press MENU/NO.

- 9** If necessary, locate the point on the MD to start recording from.

If you want to record on a new MD or start recording from the end of the recorded portion, go to step 10.

To record over from the beginning of an existing MD track

Turn AMS (or press ◀◀/▶▶ repeatedly) until the number of the track to be recorded over appears.

To record over from the middle of an MD track

Turn AMS (or press ◀◀/▶▶ repeatedly) until the number of the track to be recorded over appears, then press ▶ to start playback. Press || at the point you want to start recording from.

- 10** Press ●.

The deck changes to recording pause.

- 11** If you have set INPUT to ANALOG in step 4 above, adjust the recording level.

For details, see “Adjusting the Recording Level” on page 16.

- 12** Press ▶ or ||.

Recording starts.

- 13** Start playing the program source.

Operations you may want to do during recording

To	Press
Stop recording	■
Pause recording	
Resume recording after pausing	▶ or
Eject the MD	EJECT ▲ after stopping recording

When you pause recording

The track number increases by one. For example, if you paused recording while recording track 4, the track number will be 5 when you resume recording.

To prevent accidental erasure of the recorded material

To make it impossible to record on an MD, slide the record-protect tab in the direction of the arrow (see illustration below) to open the slot. To enable recording, close the slot.

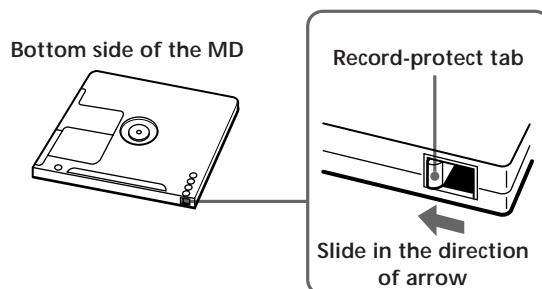

- 💡 To play the tracks you just recorded

Press ▶ immediately after stopping recording.

The deck starts to play from the first track of the material just recorded.

- 💡 To play from the first track of the MD after recording

1 Press ■ again after stopping recording.

2 Press ▶.

The deck starts to play from the first track of the MD.

Note

You can't record over existing material when Shuffle Play (page 24) or Program Play (page 25) has been selected. “Impossible” appears in the display at this time.

Adjusting the Recording Level

Do the procedure below to adjust the recording level.

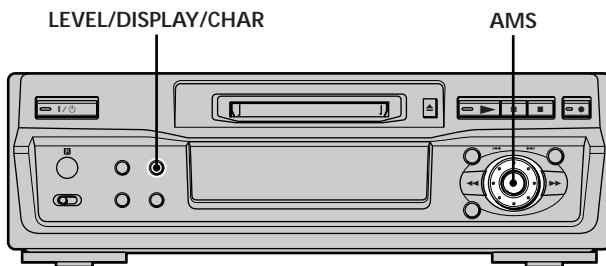

- 1 Do steps 1 to 10 of "Recording on an MD" on pages 14 and 15.
- 2 Play the portion of the program source with the strongest output.
- 3 Press LEVEL/DISPLAY/CHAR (or DISPLAY) repeatedly until the peak level meters appear.
- 4 While monitoring the sound, turn AMS (or press **◀▶** repeatedly) to raise the recording level to its highest level without turning on "OVER" on the peak level meters.
Occasional lighting of "OVER" is acceptable.



Avoid turning this indication on.

- 5 Stop playing the program source.
 - 6 To start recording, continue from step 12 of "Recording on an MD" on page 15.
- 💡** You can adjust the recording level using the remote . During recording or recording pause, press LEVEL +/- repeatedly.
- 💡** To display the level of the strongest signal
The Peak Hold function continuously displays the level of the strongest signal that has been input.
Do the procedure below to turn Peak Hold on.
- 1 While the deck is stopped, press MENU/NO twice to display "Setup Menu."
 - 2 Turn AMS (or press **◀▶** repeatedly) until "P.Hold" appears, then press AMS or YES.
 - 3 Turn AMS (or press **◀▶** repeatedly) to select "P.Hold On," then press AMS or YES.
 - 4 Press MENU/NO.
- To turn Peak Hold off, repeat the procedure above, selecting "P.Hold Off" in step 3.

Recording Tips

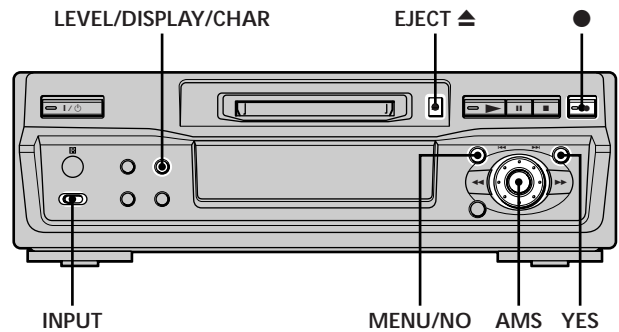

Checking the remaining recordable time on the MD

Press LEVEL/DISPLAY/CHAR (or DISPLAY) repeatedly.

While the deck is	The following information appears
Stopped	Total number of tracks and total recorded time → Remaining recordable time on the MD → Disc name
Recording	Recorded time of the current track → Remaining recordable time on the MD → Input level indication → Track name

For details, see page 12.

Monitoring the input signal (Input Monitor)

You can monitor the selected input signal even when you're not recording it.

- 1 Press EJECT to eject the MD.
- 2 Set INPUT to the position that corresponds to the jacks (connector) where the signal you want to monitor is being input.
- 3 Press .

When INPUT is set to ANALOG

The analog signal input from the LINE (ANALOG) IN jacks is output to the LINE (ANALOG) OUT jacks after A/D and D/A conversions. "AD - DA" appears in the display at this time.

When INPUT is set to DIGITAL

The digital signal input from the DIGITAL IN connector first passes through the sampling rate converter, and then output to the LINE (ANALOG) OUT jacks after D/A conversion. "- DA" appears in the display at this time.

To stop monitoring the signal

Press .

Erasing blank portions automatically (Smart Space/Auto Cut)

The deck can be set to automatically erase any blanks that are produced when the signal is interrupted during recording. The function which activates (Smart Space or Auto Cut) depends on the length of the interruption, as described below.

Smart Space

If the signal is interrupted for less than 30 seconds, Smart Space replaces the blank portion with a blank space of about three seconds, then continues the recording. "Smart Space" appears in the display during this time.

Auto Cut

If the signal is interrupted for about 30 seconds, Auto Cut replaces the blank portion with a blank space of about three seconds, then pauses the recording. "Auto Cut" appears in the display during this time.

Do the procedure below to turn Smart Space and Auto Cut on or off.

- 1 While the deck is stopped, press MENU/NO twice. "Setup Menu" appears in the display.
- 2 Turn AMS (or press ◀◀/▶▶ repeatedly) until "S.Space" appears, then press AMS or YES.
- 3 Turn AMS (or press ◀◀/▶▶ repeatedly) to select the setting, then press AMS or YES.

To	Select
Turn on Smart Space and Auto Cut	S.Space On (factory setting)
Turn off Smart Space and Auto Cut	S.Space Off

- 4 Press MENU/NO.

Notes

- If you start recording with no signal input, Smart Space and Auto Cut will not operate regardless of the setting.
- Smart Space does not affect the order of the track numbers being recorded, even if the blank space occurs in the middle of a track.
- Auto Cut is automatically turned on or off in tandem with Smart Space.
- If you turn off the deck or disconnect the AC power cord, the deck will store the last setting ("S.Space On" or "S.Space Off") and apply it the next time you turn on the deck.

Marking Track Numbers While Recording (Track Marking)

You can mark track numbers either manually or automatically while recording. By marking track numbers at specific points, you can quickly locate the points later or edit the MD easily.

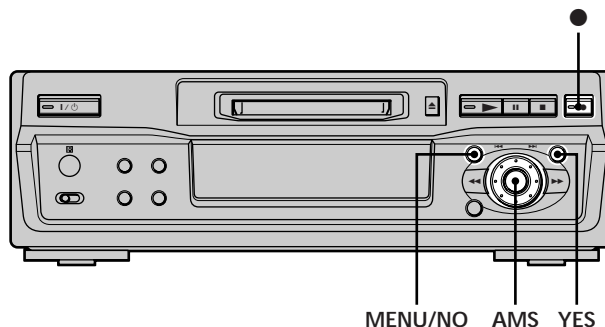

Marking track numbers manually (Manual Track Marking)

Press ● at the point where you want to add a track number while recording.

Marking track numbers automatically (Automatic Track Marking)

When recording from a CD player or MD deck connected to the DIGITAL IN connector, the deck marks track numbers in the same sequence as the source. When recording from other sources connected to the DIGITAL IN connector or a source connected to the LINE (ANALOG) IN jacks, do the procedure below to mark track numbers automatically.

- 1 While the deck is stopped, press MENU/NO twice. "Setup Menu" appears in the display.
- 2 Turn AMS (or press ◀◀/▶▶ repeatedly) until "T.Mark" appears, then press AMS or YES.
- 3 Turn AMS (or press ◀◀/▶▶ repeatedly) to select the setting, then press AMS or YES.

To	Select
Turn on Automatic Track Marking	T.Mark LSync (factory setting)
Turn off Automatic Track Marking	T.Mark Off

- 4 Press MENU/NO.

The deck marks a track number whenever the input signal level drops to -50 dB (the trigger level for Automatic Track Marking) or below for at least 1.5 seconds.

Marking Track Numbers While Recording (Track Marking)

To change the trigger level for Automatic Track Marking

Do the procedure below to change the signal level that triggers Automatic Track Marking.

- 1 While the deck is stopped, press MENU/NO twice. "Setup Menu" appears in the display.
- 2 Turn AMS (or press ◀◀/▶▶ repeatedly) until "LS(T)" appears, then press AMS or YES.
- 3 Turn AMS (or press ◀◀/▶▶ repeatedly) to select the level, then press AMS or YES.
You can set the level at any value between -72 dB and 0 dB, in 2 dB steps.
- 4 Press MENU/NO.

💡 Additional information on Automatic Track Marking

- When recording from a CD player or MD deck connected to the DIGITAL IN connector, the entire material may be recorded as a single track in the following cases:
 - When you consecutively record the same track two or more time using single-track repeat play.
 - When you consecutively record two or more tracks with the same track number but from different CDs or MDs.
 - When you record tracks from certain CD or multi-disc players.
 Also, if the source is an MD, a track number may not be marked for tracks less than four seconds long.
- When recording from a component connected to the LINE (ANALOG) IN jacks with "T.Mark Off" selected or when recording from a DAT deck or DBS tuner connected to the DIGITAL IN connector, the entire material may be recorded as a single track.
- When recording from a DAT deck or DBS tuner connected to the DIGITAL IN connector, the deck will mark a track number whenever the sampling frequency of the input signal changes, regardless of the track marking parameter setting ("T.Mark LSync" or "T.Mark Off").

💡 You can mark track numbers even after recording has finished

See "Dividing Tracks" on page 31.

Note

If you turn off the deck or disconnect the AC power cord, the deck will store the last settings ("T.Mark LSync" or "T.Mark Off" and the trigger level) and apply them the next time you turn on the deck.

Starting Recording With Six Seconds of Prestored Audio Data (Time Machine Recording)

Whenever the deck is in recording pause, the deck's buffer memory continuously stores the latest six seconds worth of audio data. When you press AMS (or T.REC), the recording then starts with the data in the buffer memory. Time Machine Recording thus allows you to avoid missing the beginning of material recorded live from an FM or satellite broadcast.

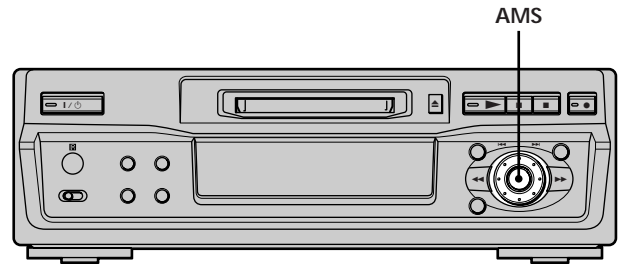

- 1 Do steps 1 to 10 of "Recording on an MD" on pages 14 and 15.
The deck changes to recording pause.
- 2 Start playing the program source.
- 3 Press AMS (or T.REC) at the point where you want to start recording.
Recording starts with the six seconds of prestored data in the buffer memory, then continues recording via the buffer memory thereafter.

To stop Time Machine Recording

Press ■.

Note

The storage of data in the buffer memory starts from the moment the deck changes to recording pause. Thus, if you start recording less than six seconds after changing to recording pause, less than six seconds worth of data will be recorded from the buffer memory. The same is true if the program source had been playing for less than six seconds at the time you start recording.

Synchro-recording With the Audio Component of Your Choice (Music Synchro-recording)



The Music Synchro-recording allows you to automatically synchronize recording on the MD deck with the playing of the selected program source. The Track Marking function, however, will differ according to the program source. For details, see “Marking Track Numbers While Recording” on page 17.

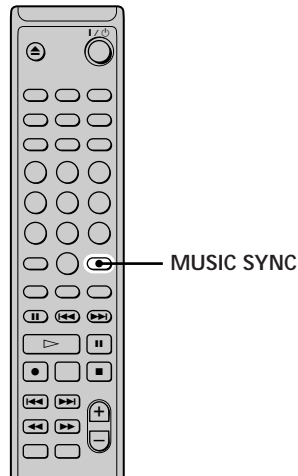

- 1 Do steps 1 to 9 of “Recording on an MD” on pages 14 and 15.
- 2 Press MUSIC SYNC.
The deck changes to recording pause.
- 3 Start playing the program source.
Recording starts automatically.

To stop Music Synchro-recording

Press ■.

Note

During Music Synchro-recording, Smart Space and Auto Cut will operate regardless of their setting (“S.Space On” or “S.Space Off”).

Synchro-recording With a Sony CD Player

(CD Synchro-recording)

When the deck is connected to a Sony CD player or Hi-Fi component system, you can easily copy the contents of CDs to the MD using the deck’s remote. As the same remote operates both the MD deck and the CD player or CD player section of the component system, make sure to place the MD deck and the CD player as close together as possible.

Note

On some CD players and Hi-Fi component systems, you may find it impossible to perform CD Synchro-recording using the deck’s remote. In this case, use Music Synchro-recording (this page) to record from CDs to the MD.

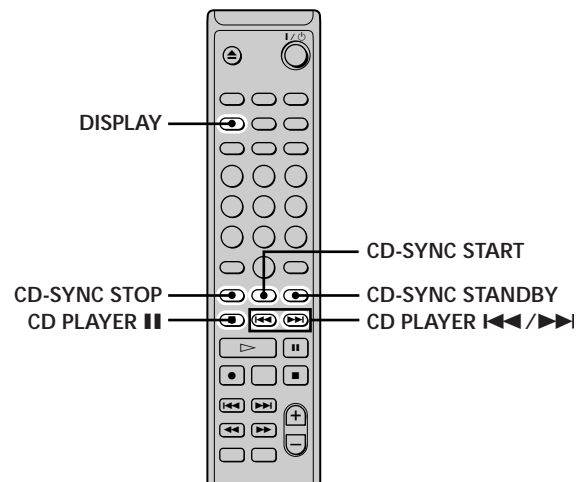

- 1 Turn on the amplifier and the CD player, and select CD on the amplifier.
- 2 Do steps 2 to 9 of “Recording on an MD” on pages 14 and 15.
- 3 Insert a CD into the CD player and select the playback mode (shuffle play, program play, etc.) on the CD player.
- 4 Press CD-SYNC STANDBY.
The CD player changes to play standby and the MD deck changes to recording standby.
- 5 Press CD-SYNC START.
The deck starts recording and the CD player starts to play.
The track number and elapsed recording time of the track appear in the display.

If the CD player doesn’t start playing

Some CD players may not respond when you press CD-SYNC START. Press ■ on the CD player’s remote instead to start play on the CD player.

Synchro-recording With a Sony CD Player (CD Synchro-recording)

Operations you may want to do during CD Synchro-recording

To	Press
Stop recording	CD-SYNC STOP
Pause recording	CD-SYNC STANDBY or CD PLAYER
Locate the next track to be recorded during recording pause	CD PLAYER I◀◀/▶▶I
Resume recording after pausing	CD-SYNC START or CD PLAYER
Check the remaining recordable time on the MD	DISPLAY (page 12)

 You can use the remote of the CD player during CD Synchro-recording

Press	To change the deck to	And change the CD player to
▷	Recording	Play
■	Recording pause	Stop
 	Recording pause	Pause

 During CD Synchro-recording, track numbers are marked in the following ways:

- When the CD player is connected to the DIGITAL IN connector, track numbers are automatically marked as they appear on the CD.
- When the CD player is connected to the LINE (ANALOG) IN jacks, track numbers are automatically marked when “T.Mark LSync” has been selected (page 17).
- When you resume recording after recording pause, a new track number is automatically marked, regardless of the track marking parameter setting (“T.Mark LSync” or “T.Mark Off”).

 You can change CDs during CD Synchro-recording

- 1 Press **■** on the CD player’s remote.
- 2 Change the CD.
- 3 Press **▷** on the CD player’s remote.
Recording resumes.

 You can also perform synchro-recording with a Sony video CD player

By reprogramming the MD deck’s remote, you can use the procedure above to perform Synchro-recording with a Sony video CD player.

Press number button 2 while pressing down **I/⏻** on the MD deck’s remote. You can now operate the MD deck and the video CD player with the remote. To control the CD player again, press number button 2 while pressing down **I/⏻** on the MD deck’s remote.

Notes

- When performing CD Synchro-recording with a CD player with a mode selector, be sure to set the selector to CD1.
- When you record tracks from certain CD or multi-disc players, the entire material may be recorded as a single track.

Playing MDs

This chapter explains the various ways to play MDs.

Playing an MD

The operations for normal play are explained below.

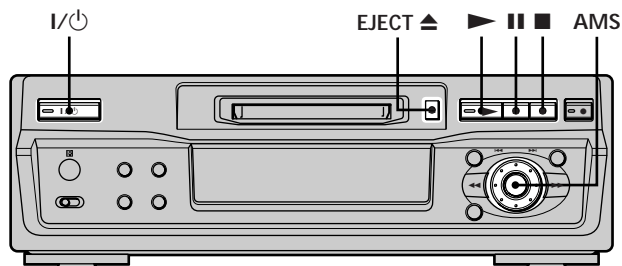

- 1 Turn on the amplifier and select MD on the amplifier.
- 2 Press I/⏻ to turn on the deck.
The switch indicator turns off.
- 3 Insert an MD.
- 4 If necessary, turn AMS (or press ▶▶I repeatedly) to locate the track you want to start playing from.
If you want to play from the first track, go to step 5.
- 5 Press ▶.
The deck starts to play.
- 6 Adjust the volume on the amplifier.

Operations you may want to do during play

To	Press or turn
Stop play	■
Pause play	
Resume play after pausing	▶ or
Locate a succeeding track	AMS clockwise (or press ▶▶I repeatedly)
Locate the beginning of the current track or a preceding track	AMS counterclockwise (or press ◀◀I repeatedly)
Eject the MD	EJECT ▲ after stopping play

Playing a Specific Track

While the deck is playing or stopped, use the procedure below to quickly play any track.

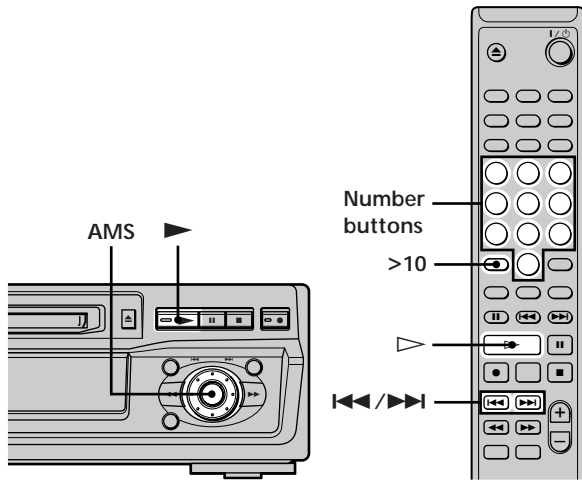

Playing MDS

Locating a track with AMS*

To go to	Do the following:
The next or a succeeding track during play	Turn AMS clockwise (or press ►► repeatedly).
A preceding track during play	Turn AMS counterclockwise (or press ◀◀ repeatedly).
The beginning of the current track during play	Turn AMS counterclockwise (or press ◀◀ once).
A specific track while the deck is stopped	Turn AMS (or press ◀◀ / ►► repeatedly) until the track number you want to go to appears in the display, then press AMS or ►.

* Automatic Music Sensor

💡 To locate the last track of the MD quickly
While the deck is stopped, turn AMS counterclockwise (or press ◀◀ once).

💡 If you locate a track while the deck is stopped or paused
The deck will still be stopped or paused at the beginning of the located track.

Playing a track by entering the track number

Press the number button(s) to enter the number of the track you want to play.

To enter a track number over 10

- 1 Press >10 (see the examples below).
- 2 Enter the corresponding digits.
To enter 0, press 10/0 instead.

Examples:

- To play track number 30, press >10 once, then 3 and 10/0.
- To play track number 108, press >10 twice, then 1, 10/0, and 8.

💡 If you enter a track number while the deck is paused
The deck will still be paused at the beginning of the track.

Locating a Particular Point in a Track

You can locate a particular point in a track during play or play pause.

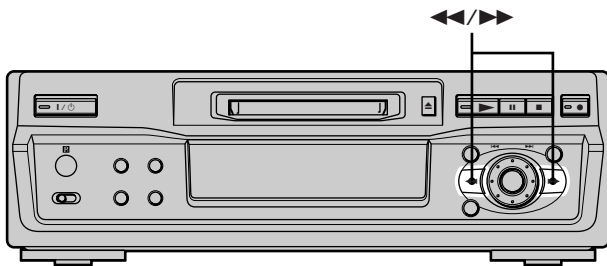

Locating a point while monitoring the sound

Press down **◀▶** during play. You will hear intermittent playback as the disc goes forward or reverse. When you reach the point, release the button.

Notes

- If the disc reaches the end while you're pressing **▶▶**, the deck stops.
- Tracks that are only a few seconds long may be too short for monitoring. For such tracks, play the MD at normal speed.

Locating a point by observing the time indication

Press down **◀▶** during play pause. The elapsed playing time of the track appears in the display. When you reach the point, release the button. No sound is output during this time.

💡 When “- Over -” appears in the display

The disc has reached the end while you're pressing **▶▶**. Turn AMS counterclockwise (or press **◀◀**) or press **◀◀** to go back.

Playing Tracks Repeatedly

You can play an entire MD repeatedly. This function can be used with Shuffle Play to repeat all the tracks in random order (page 24), or with Program Play to repeat all the tracks in the program (page 25). You can also repeat a specific track or portion within a track.

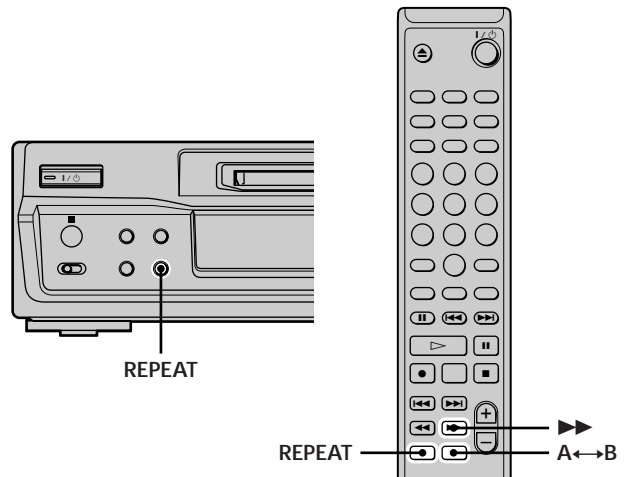

Note

If you turn off the deck or disconnect the power cord, the deck will store the last setting of the repeat play (“Repeat All” or “Repeat 1”) and recall it the next time you turn on the deck.

Repeating all the tracks on the MD (Repeat All Play)

Press **REPEAT** repeatedly until “Repeat All” appears in the display.

When you play an MD, the deck repeats the tracks as follows:

When the play mode is	The deck repeats
Normal play (page 21)	All the tracks in sequence
Shuffle Play (page 24)	All the tracks in random order
Program Play (page 25)	All the tracks in the program in sequence

To stop Repeat All Play

Press **■**.

To resume normal play

Press **REPEAT** repeatedly until “Repeat Off” appears in the display.

Playing Tracks Repeatedly

Repeating the current track (Repeat 1 Play)

While the track you want to repeat is being played, press REPEAT repeatedly until "Repeat 1" appears in the display.

Repeat 1 Play starts.

To stop Repeat 1 Play

Press ■.

To resume normal play

Press REPEAT repeatedly until "Repeat Off" appears in the display.

Repeating a specific portion within a track (Repeat A-B Play)

You can specify one portion within a track to be played repeatedly. Note that the portion that you specify must be within the boundaries of a single track.

- 1 While the deck is playing, press A↔B at the starting point (point A) of the portion to be played repeatedly.
"REPEAT A-" lights up and "B" flashes in the display.
- 2 Continue playing the track or press ►► to locate the ending point (point B), then press A↔B.
"REPEAT A-B" lights up and Repeat A-B Play starts.

To stop Repeat A-B Play and resume normal play

Press REPEAT or ■.

 You can set a new starting point and ending point during Repeat A-B Play

You can change the current ending point to a new starting point, then specify a new ending point to repeat a portion right after the current portion.

- 1 During Repeat A-B Play, press A↔B.
The current ending point changes to the new starting point (point A).
"REPEAT A-" lights up and "B" flashes in the display.
- 2 Locate the new ending point (point B) and press A↔B.
"REPEAT A-B" lights up and the deck starts to repeat the newly specified portion.

Playing Tracks in Random Order (Shuffle Play)

When you select Shuffle Play, the deck plays all the tracks on the MD in random order.

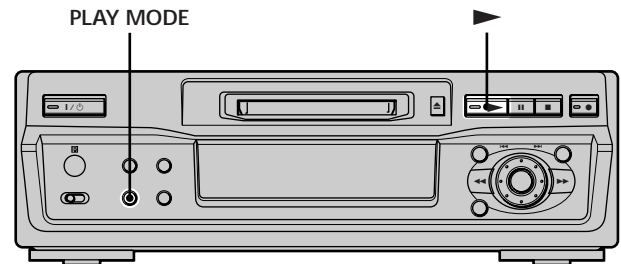

- 1 While the deck is stopped, press PLAY MODE repeatedly until "SHUFFLE" lights up in the display.
- 2 Press ►.
Shuffle Play starts.
 appears while the deck is "shuffling" the tracks.

To resume normal play

While the deck is stopped, press PLAY MODE repeatedly until "SHUFFLE" turns off.

 You can locate tracks during Shuffle Play
Turn AMS (or press ◀◀/▶▶ repeatedly).

- To locate the next track or a later track to be played, turn AMS clockwise (or press ▶▶ repeatedly).
- To locate the beginning of the current track, turn AMS counterclockwise (or press ◀◀). Note that you can't locate and play the tracks that have already been played once.

Creating Your Own Program (Program Play)

You can pick out the tracks that you like and specify the playback order in a program containing up to 25 tracks.

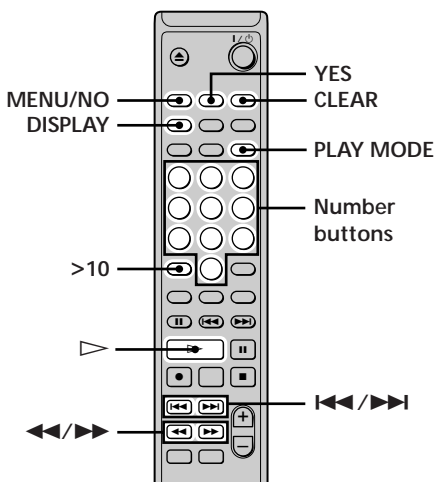
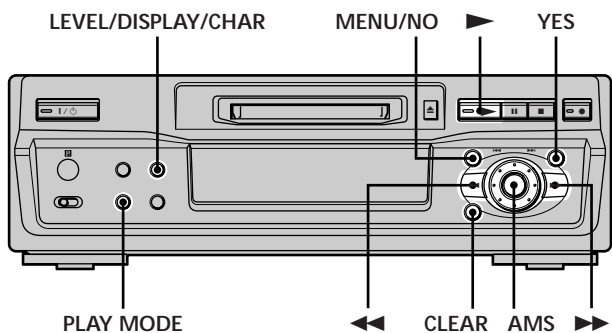

Programming the tracks

- 1 While the deck is stopped, press MENU/NO twice. "Setup Menu" appears in the display.
- 2 Turn AMS (or press **◀◀/▶▶** repeatedly) until "Program ?" appears, then press AMS or YES.
- 3 Turn AMS until the track number you want to add to the program appears, then press AMS or **▶▶** (or use the number button(s) to enter the track directly).

If you entered the wrong track number

Press **◀◀/▶▶** repeatedly until the wrong track number flashes, then do step 3 above again.

To enter a track number over 10

Use >10. For details, see page 22.

To check the total playing time of the program

Press LEVEL/DISPLAY/CHAR (or DISPLAY).

- 4 Repeat step 3 to enter other tracks.

- 5 Press YES. "Complete!!" appears and the program is completed.
- 6 Press PLAY MODE repeatedly until "PROGRAM" lights up in the display.
- 7 Press **▶**. Program Play starts.

To stop Program Play

Press **■**.

To resume normal play

Press PLAY MODE repeatedly until "PROGRAM" turns off.

The program remains even after Program Play ends or is stopped

Press **▶** to play the program again.

Notes

- If you eject the MD or disconnect the AC power cord, the program will be lost.
- The display shows " - - - m - - s" when the total playing time of the program exceeds 199 minutes.
- "ProgramFull!" appears when you program 25th track.

Checking the contents of the program

While the deck is stopped and "PROGRAM" lights up, press LEVEL/DISPLAY/CHAR (or DISPLAY) repeatedly. The first several tracks in the program appear in the display. To see the rest of the program, turn AMS (or press **◀◀/▶▶** repeatedly).

Creating Your Own Program (Program Play)

Changing the contents of the program

While the deck is stopped and "PROGRAM" lights up, do steps 1 and 2 of "Programming the tracks" on page 25, followed by one of the procedures below:

To	Do the following:
Erase a track	Press ◀▶ repeatedly until the number of the unwanted track flashes, then press CLEAR.
Erase all tracks	Press CLEAR repeatedly until all the track numbers disappear.
Add a track at the beginning of the program	Press ◀ repeatedly until "0" flashes before the first track number, then do steps 3 to 5 of "Programming the tracks" on page 25.
Add a track in the middle of the program	Press ◀▶ repeatedly until the track number which will precede the new track flashes. Press AMS to display flashing "0," then do steps 3 to 5 of "Programming the tracks" on page 25.
Add a track to the end of the program	Press ▶▶ repeatedly until "0" flashes after the last track number, then do steps 3 to 5 of "Programming the tracks" on page 25.
Replace a track	Press ◀▶ repeatedly until the number of the track to be changed flashes, then do steps 3 to 5 of "Programming the tracks" on page 25.

Tips for Recording From MDs to Tape

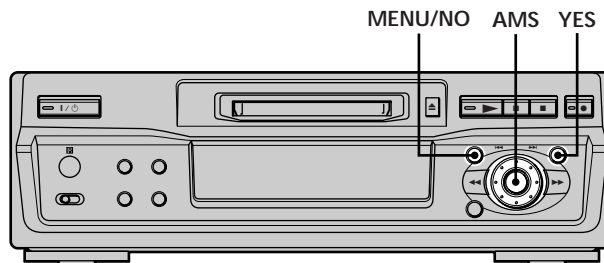

Inserting blanks between tracks during play (Auto Space)

The MD deck can be set to automatically insert a three-second blank between tracks during play. This function is useful when you're recording from an MD to an analog tape since the three-second blank enables you to use the Multi-AMS function later to locate the beginning of tracks on the tape.

- 1 While the deck is stopped, press MENU/NO twice. "Set up Menu" appears in the display.
- 2 Turn AMS (or press ◀▶ repeatedly) until "Auto" appears, then press AMS or YES.
- 3 Turn AMS (or press ◀▶ repeatedly) to select the setting, then press AMS or YES.

To	Select
Turn on Auto Space	Auto Space
Turn off Auto Space	Auto Off (factory setting)

- 4 Press MENU/NO.

Notes

- If you select "Auto Space" and record a selection containing multiple track numbers (for example, a medley or symphony), blank spaces will be created on the tape in between the various sections.
- If you turn off the deck or disconnect the AC power cord, the deck will store the last setting ("Auto Space" or "Auto Off") and recall it the next time you turn on the deck.

Pausing after each track (Auto Pause)

You can set the MD deck so that it pauses after each track to give you time to locate the next track to be recorded.

- 1** While the deck is stopped, press MENU/NO twice.
“Setup Menu” appears in the display.
- 2** Turn AMS (or press ◀◀/▶▶ repeatedly) until
“Auto” appears, then press AMS or YES.
- 3** Turn AMS (or press ◀◀/▶▶ repeatedly) to select
the setting, then press AMS or YES.

To	Select
Turn on Auto Pause	Auto Pause
Turn off Auto Pause	Auto Off (factory setting)

- 4** Press MENU/NO.

To resume play after pausing

Press ▶.

Note

If you turn off the deck or disconnect the AC power cord, the deck will store the last setting (“Auto Pause” or “Auto Off”) and recall it the next time you turn on the deck.

Editing Recorded MDs

This chapter explains how to edit the tracks that have been recorded on an MD.

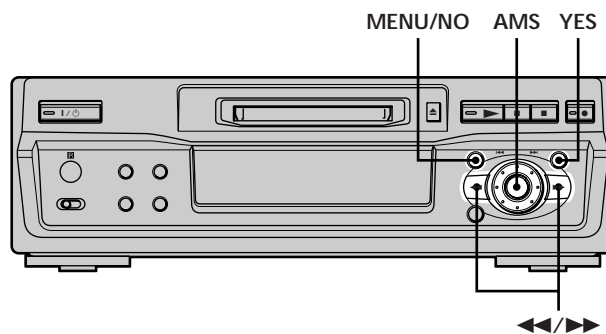

Brief descriptions of buttons and control used to edit MDs

The buttons and the control below are used to erase, divide, move, or combine tracks on the MD.

Note

The operation of these buttons and the control is different when naming a track or MD. For details, see “Naming a Track or MD” on page 33.

MENU/NO button: While the deck is stopped, playing, or paused, press to edit tracks. While editing, press to cancel editing.

AMS control: Turn to select an editing operation or track number, then press to enter your selection. You can also use the control to specify points in a track for erasure or track division.

YES button: Press this button instead of the AMS control to enter a selection.

\ll/\gg buttons: Press to specify the unit (minute, second, or frame) by which the MD is advanced when the AMS control is turned. You can also use these buttons to locate the end point of the portion to be erased.

For further details on the function of each button and control, see the sections on editing operations.

About indication which appears while editing

When "Protected" appears in the display

The record-protect slot is open. To edit the MD, slide the tab to close the slot. For details, see "To prevent accidental erasure of the recorded material" on page 15.

About indications which appear after editing

When "TOC" lights up in the display

Editing has finished but the TOC (Table of Contents) on the MD has not been updated to reflect the editing results. The editing will be lost if you disconnect the AC power cord while the indication is on. The TOC will be updated only when you eject the MD or turn off the MD deck.

When "TOC Writing" flashes in the display

The deck is updating the TOC. Do not disconnect the AC power cord or move the deck while the indication flashes.

Erasing Tracks

You can erase a track or part of a track simply by specifying the number of the track or the portion within a track to be erased. You can also erase all the tracks on an MD at one time.

Erasing a track

Specify the number of the track you want to erase.

Example: Erasing the second track

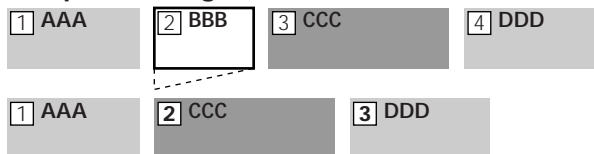

When you erase a track, all the tracks after the one erased are automatically renumbered. For example, if you erase track number 2, the previous track number 3 becomes track number 2 and the previous track number 4 becomes track number 3, and so on.

- 1** While the deck is stopped, playing, or paused, press MENU/NO.
"Edit Menu" appears in the display.
- 2** Turn AMS (or press ◀▶ repeatedly) until "Tr Erase ?" appears, then press AMS or YES.
The deck starts to play the track indicated by the number in the display.
- 3** Turn AMS (or press ◀▶ repeatedly) until the track number you want to erase appears.
- 4** Press AMS or YES.
"Complete!!" appears for a few seconds and the track is erased. The track following the erased track starts to play. If the erased track is the last one on the MD, the track preceding the erased track starts to play.

To cancel the operation

Press MENU/NO or ■.

💡 If "Erase ???" appears in step 4 above
The track has been record-protected on another MD deck. If you still want to erase the track, press AMS or YES again while the indication appears.

💡 To avoid confusion when erasing more than one track
Start erasing from the highest numbered track. This way you'll avoid renumbering the tracks that you plan to erase.

💡 You can undo the erasure
For details, see "Undoing the Last Edit" on page 36.

Erasing all the tracks on an MD

Do the procedure below to erase all the tracks, track names, and disc name at once.

- 1 While the deck is stopped, playing, or paused, press MENU/NO. "Edit Menu" appears in the display.
- 2 Turn AMS (or press ◀◀/▶▶ repeatedly) until "All Erase ?" appears, then press AMS or YES. "All Erase ??" appears in the display.
- 3 Press AMS or YES. "Complete!!" appears for a few seconds and all the tracks, track names, and disc name are erased.

To cancel the operation

Press MENU/NO or ■.

💡 You can undo the erasure

For details, see "Undoing the Last Edit" on page 36.

Erasing a portion of a track

You can easily erase a portion of a track by specifying the starting and ending points of the erasure.

This is useful for erasing the unnecessary portions of a track recorded from a satellite or FM broadcast.

Example: Erasing portion "B2" of the second track

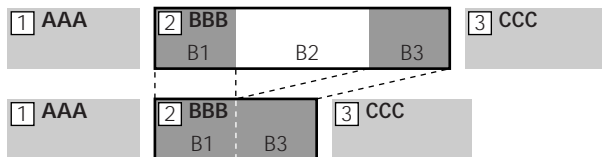

- 1 While the deck is stopped, playing, or paused, press MENU/NO. "Edit Menu" appears in the display.
- 2 Turn AMS (or press ◀◀/▶▶ repeatedly) until "A-B Erase ?" appears, then press AMS or YES.
- 3 Turn AMS (or press ◀◀/▶▶ repeatedly) until the number of the track containing the portion to be erased flashes, then press AMS or YES. "-Rehearsal-" and "Point A ok?" alternate in the display and the deck plays the first several seconds of the track repeatedly.

- 4 While monitoring the sound, turn AMS (or press ◀◀/▶▶ repeatedly) to locate the starting point of the portion to be erased (point A). The time indication ("m (minute)," "s (second)," and "f (frame = 1/86 second)") of the current point is displayed and several seconds of the track from that point play back repeatedly.

To find a point quickly

Specify a unit (minute, second, or frame) by which the MD is advanced when you turn AMS (or press ◀◀/▶▶ repeatedly).

To do this, press ◀◀/▶▶ in step 4 repeatedly to select "m," "s," or "f." The selected unit flashes in the display.

- 5 Repeat step 4 until you've located point A.
- 6 Press AMS or YES to enter point A. "Point B set" appears and several seconds of the track from point A play back repeatedly.
- 7 Continue playing the track or press ▶▶ to locate the ending point of the portion to be erased (point B), then press AMS or YES. "A-B Ers" and "Point B ok?" alternate in the display and a few seconds of the track before point A and after point B play back repeatedly.
- 8 Repeat step 4 until you've located point B.
- 9 Press AMS or YES to enter point B. "Complete!!" appears for a few seconds and the portion between point A and B is erased.

To cancel the operation

Press MENU/NO or ■.

💡 You can undo the erasure

For details, see "Undoing the Last Edit" on page 36.

Note

In the following cases, "Impossible" appears and you can't erase a portion of a track:

- The point B you entered comes before point A.
- After repeated editing of a track, it may become impossible to erase a portion of the track any further. This is a technical limitation of the MD system and is not a mechanical error.

Dividing Tracks

You can divide a recorded track at any point simply by adding a track mark at that point. This is especially useful when you want to divide recorded material which contains multiple tracks but only one track number (see page 18), or when you want to locate a certain point in the track.

Example: Dividing the second track

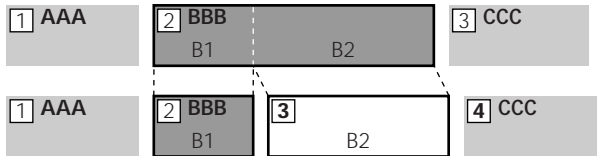

When you divide a track, the total number of tracks increases by one and all tracks following the divided track are automatically renumbered.

Dividing a track after selecting the track

- 1 While the deck is stopped, playing, or paused, press MENU/NO.
“Edit Menu” appears in the display.
- 2 Turn AMS (or press ◀▶ repeatedly) until “Divide ?” appears, then press AMS or YES.
- 3 Turn AMS (or press ◀▶ repeatedly) until the number of the track you want to divide flashes, then press AMS or YES.
“-Rehearsal-” appears and the track starts to play.
- 4 While monitoring the sound, turn AMS (or press ◀▶ repeatedly) to locate the dividing point. The time indication (“m,” “s,” and “f”) of the current point is displayed and several seconds of the track from that point play back repeatedly.
To find a point quickly
Specify a unit (minute, second, or frame) by which the MD is advanced when you turn AMS (or press ◀▶ repeatedly).
To do this, press ◀▶ in step 4 repeatedly to select “m,” “s,” or “f.” The selected unit flashes in the display.
- 5 Repeat step 4 until you’ve located the dividing point.
- 6 Press AMS or YES.
“Complete!!” appears for a few seconds and the track is divided. The deck starts to play the newly created track. Note that new track has no name.

To cancel the operation

Press MENU/NO or ■.



You can undo the track division

For details, see “Undoing the Last Edit” on page 36.



You can divide tracks while recording

For details, see “Marking Track Numbers While Recording” on page 17.

Dividing a track after selecting the dividing point

- 1 While the deck is playing, press AMS at the point you want to divide the track.
“- Divide -” and “-Rehearsal-” alternate in the display and the deck starts to play from the selected point.
- 2 If necessary, do step 4 of “Dividing a track after selecting the track” on this page to finely adjust the dividing point.
- 3 Press YES.
“Complete!!” appears for a few seconds and the track is divided. The deck starts to play the newly created track. Note that new track has no name.

To cancel the operation

Press MENU/NO or ■.



You can undo the track division

For details, see “Undoing the Last Edit” on page 36.



You can divide tracks while recording

For details, see “Marking Track Numbers While Recording” on page 17.

Combining Tracks

This function allows you to combine any two tracks into a single track. The two tracks need not to be consecutive nor chronological. You can combine several tracks into a single medley, or several independently recorded portions into a single track. When you combine two tracks, the total number of tracks decreases by one and all tracks following the combined track are renumbered.

Example: Combining the second track and the fourth track

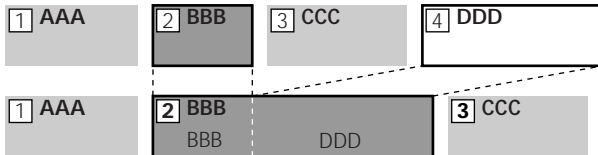

If both of the combined tracks have a track name, the name of the second track is erased.

- 1 While the deck is stopped, playing, or paused, press MENU/NO.
“Edit Menu” appears in the display.
- 2 Turn AMS (or press ◀▶ repeatedly) until “Combine ?” appears, then press AMS or YES.
- 3 Turn AMS (or press ◀▶ repeatedly) until the number of the first track of the two to be combined appears, then press AMS or YES.
The display for selecting a second track appears and the deck plays the portion where joining will occur (the end of the first track and the beginning of the track following it) repeatedly.
- 4 Turn AMS (or press ◀▶ repeatedly) until the number of the second track of the two to be combined appears, then press AMS or YES.
“Complete!!” appears for a few seconds and the tracks are combined. The deck starts to play the combined track.

To cancel the operation

Press MENU/NO or ■.

💡 You can undo the combination

For details, see “Undoing the Last Edit” on page 36.

Note

If “Impossible” appears in the display, the tracks can’t be combined because repeated editing has been done to the track(s). This is a technical limitation of the MD system and is not a mechanical error.

Moving Tracks

This function lets you change the order of any track.

Example: Moving the second track after the third track

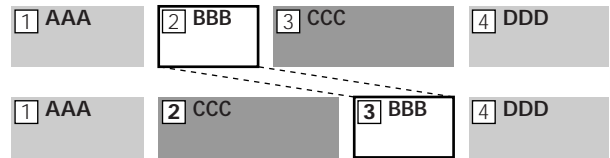

After you move a track, the tracks are renumbered automatically.

- 1 While the deck is stopped, playing, or paused, press MENU/NO.
“Edit Menu” appears in the display.
- 2 Turn AMS (or press ◀▶ repeatedly) until “Move ?” appears, then press AMS or YES.
- 3 Turn AMS (or press ◀▶ repeatedly) until the number of the track to be moved appears, then press AMS or YES.
- 4 Turn AMS (or press ◀▶ repeatedly) until the new track position appears, then press AMS or YES.
“Complete!!” appears for a few seconds and the track is moved. The deck starts to play the moved track.

To cancel the operation

Press MENU/NO or ■.

💡 You can undo the track move

For details, see “Undoing the Last Edit” on page 36.

Naming a Track or MD

You can enter a name for a recorded MD as well as for individual tracks. Names can consist of uppercase and lowercase letters, numbers, and symbols. A total number of 1,700 characters can be stored for all the names on the MD.

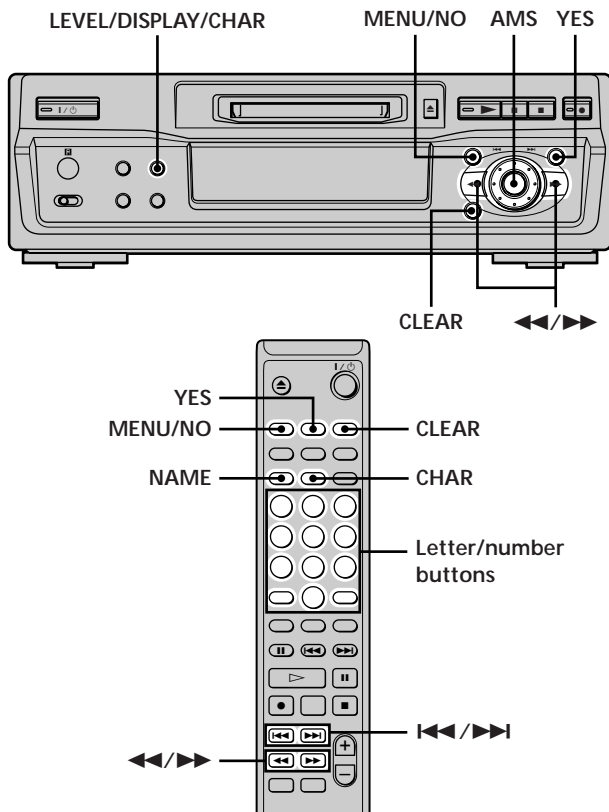

Note

If you name a track while it is being recorded, be sure to finish the naming operation before the track ends. If the track ends before you finish, the entered character data will be discarded and the track will remain unnamed. Also, you can't name tracks while the deck is recording over existing material.

Naming a track or MD using the controls on the deck

1 Press MENU/NO while the deck is in one of the operating statuses listed below, depending on what you want to name:

To name	Press while the deck is
A track or the MD	Stopped, playing, or paused
The track being recorded	Recording the track

“Edit Menu” appears in the display.

2 Turn AMS until “Name ?” appears, then press AMS or YES.

While the deck is recording, a flashing cursor appears in the display and you can enter a name for the track being recorded. In this case, go to step 6.

3 Turn AMS until “Nm In ?” appears, then press AMS or YES.

4 Turn AMS until the track number (when naming a track) or “Disc” (when naming the MD) flashes, then press AMS or YES.

5 Press AMS or YES again. A flashing cursor appears.



6 Press LEVEL/DISPLAY/CHAR repeatedly to select the character type.

To select	Press repeatedly until
Uppercase letters	“A” appears in the display
Lowercase letters	“a” appears in the display
Numbers	“0” appears in the display
Symbols*	“!” appears in the display

* The following symbols can be selected:

! " # \$ % & ' () * + , - . / : ; < = > ? @ _ `



To enter a space

Press ► while the cursor is flashing.

7 Turn AMS to select the character.

The selected character flashes.



To change a selected character

Repeat steps 6 and 7.

Naming a Track or MD

- 8** Press AMS.
The selected character is entered and lights continuously. The cursor shifts to the right, flashes, and waits for the input of the next character.



- 9** Repeat steps 6 to 8 to enter the rest of the name.

To change a character

Press ◀◀/▶▶ repeatedly until the character to be changed flashes, then repeat steps 6 to 8.

To erase a character

Press ◀◀/▶▶ repeatedly until the character to be erased flashes, then press CLEAR.

- 10** Press YES.
The whole name appears in the display.

To cancel the operation

Press MENU/NO or ■.

You can undo the naming of a track or MD
For details, see “Undoing the Last Edit” on page 36.

Naming a track or MD using the remote

- 1** Press NAME while the deck is in one of the operating statuses listed below, depending on what you want to name:

To name	Press while the deck is
A track	Playing, paused, recording, or stopped with the track number displayed
The MD	Stopped with no track number displayed

A flashing cursor appears in the display.

- 2** Press CHAR repeatedly to select the character type.

To select	Press repeatedly until
Uppercase letters	“Selected ABC” appears in the display
Lowercase letters	“Selected abc” appears in the display
Numbers or symbols	“Selected 123” appears in the display

- 3** Enter a character.

If you’ve selected uppercase or lowercase letters

- Press the corresponding letter/number button repeatedly until the character to be entered flashes.
Or, press the button once and press ◀◀/▶▶ repeatedly.
- Press ▶▶.

The flashing character is entered and lights continuously and the cursor shifts to the right.

If you’ve selected numbers

Press the corresponding number button.
The number is entered and the cursor shifts to the right.

- 4** Repeat steps 2 and 3 to enter the rest of the name.

To change a character

Press ◀◀/▶▶ repeatedly until the character to be changed flashes, press CLEAR to erase the character, then repeat steps 2 and 3.

- 5** Press NAME.
The whole name appears in the display.

To cancel the operation

Press MENU/NO or ■.

You can undo the naming of a track or MD
For details, see “Undoing the Last Edit” on page 36.

Copying a track or disc name

You can copy an existing track or disc name and use it to name another track on the same disc or the disc itself.

- While the deck is stopped, playing, or paused, press MENU/NO.
“Edit Menu” appears in the display.
- Turn AMS (or press ◀◀/▶▶ repeatedly) until “Name ?” appears, then press AMS or YES.
- Turn AMS (or press ◀◀/▶▶ repeatedly) until “Nm Copy ?” appears, then press AMS or YES.
- Turn AMS (or press ◀◀/▶▶ repeatedly) until the number of the track (when copying the track name) or “Disc” (when copying the disc name) flashes, then press AMS or YES to copy the selected name.

When “No Name” appears in the display
The selected track or disc has no name.

- Turn AMS (or press **◀◀/▶▶** repeatedly) until the number of the track (when naming a track) or "Disc" (when naming a disc) flashes, then press AMS or YES to enter the copied name. "Complete!!" appears for a few seconds and the name is copied.

To cancel the operation

Press MENU/NO or **■**.

 When "Overwrite ??" appears in step 5 above The track or the disc selected in step 5 already has a name. If you wish to replace the name, press AMS or YES again while the indication appears in the display.

 You can undo the copying of a track or disc name For details, see "Undoing the Last Edit" on page 36.

Renaming a track or MD 

- Press NAME while the deck is in one of the operating statuses listed below, depending on what you want to rename:

To rename	Press while the deck is
A track	Playing, paused, recording, or stopped with the track number displayed
The MD	Stopped with no track number displayed

A track or disc name appears in the display.

- Press down CLEAR until the selected name is erased completely.
- Do steps 6 to 9 of "Naming a track or MD using the controls on the deck" on pages 33 and 34 or steps 2 to 4 of "Naming a track or MD using the remote" on page 34.
- Press NAME.

Erasing a track or disc name

Use this function to erase the name of a track or disc.

- While the deck is stopped, playing, recording, or paused, press MENU/NO. "Edit Menu" appears in the display.
- Turn AMS (or press **◀◀/▶▶** repeatedly) until "Name ?" appears, then press AMS or YES.
- Turn AMS (or press **◀◀/▶▶** repeatedly) until "Nm Erase ?" appears, then press AMS or YES.

- Turn AMS (or press **◀◀/▶▶** repeatedly) until the number of the track (when erasing the track name) or "Disc" (when erasing the disc name) flashes, then press AMS or YES. "Complete!!" appears for a few seconds and the name is erased.

To cancel the operation

Press MENU/NO or **■**.

 You can undo the erasing of a track or disc name For details, see "Undoing the Last Edit" on page 36.

Erasing all the names on the MD

You can erase all the track names and the disc name on an MD in a single operation.

- While the deck is stopped, playing, or paused, press MENU/NO. "Edit Menu" appears in the display.
- Turn AMS (or press **◀◀/▶▶** repeatedly) until "Name ?" appears, then press AMS or YES.
- Turn AMS (or press **◀◀/▶▶** repeatedly) until "Nm All Ers ?" appears, then press AMS or YES. "Nm All Ers??" appears in the display.
- Press AMS or YES. "Complete!!" appears for a few seconds and all the names on the MD are erased.

To cancel the operation

Press MENU/NO or **■**.

 You can undo the erasing of all the names on the MD For details, see "Undoing the Last Edit" on page 36.

 You can erase all the recorded tracks and names on the MD For details, see "Erasing all the tracks on an MD" on page 30.

Undoing the Last Edit

You can undo the last edit operation and restore the contents of the MD to the condition that existed before the operation. Note, however, that you can't undo an edit operation if you perform any of the following operations after the edit:

- Press **●** on the deck
- Press **●** or MUSIC SYNC on the remote
- Turn off the deck or eject the MD
- Disconnect the AC power cord.

4 Press AMS or YES.

"Complete!!" appears for a few seconds and the MD is restored to the condition that existed before the edit operation.

To cancel the operation

Press MENU/NO or **■**.

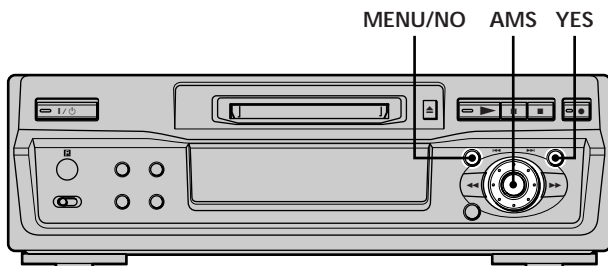

- 1** While the deck is stopped and no track number appears in the display, press MENU/NO. "Edit Menu" appears in the display.
- 2** Turn AMS (or press **◀◀/▶▶** repeatedly) until "Undo ?" appears. "Undo ?" doesn't appear if no editing has been done.
- 3** Press AMS or YES. One of the following messages appears depending on the last edit operation.

Last edit operation	Message
Erasing a track	
Erasing all the tracks on an MD	Erase Undo?
Erasing a portion of a track	
Dividing a track	Divide Undo?
Combining tracks	CombineUndo?
Moving a track	Move Undo?
Naming a track or MD	
Copying a track or disc name	
Renaming a track or MD	Name Undo?
Erasing a track or disc name	
Erasing all the names on the MD	

Other Functions

This chapter explains other useful functions that are available on the MD deck.

Fade In and Fade Out

You can use Fade-in Play to gradually increase the signal level output to the LINE (ANALOG) OUT jacks at the start of playback. Fade-out Play gradually decreases the signal level at the end of playback.

Fade-in Recording gradually increases the signal level at the start of recording. Fade-out Recording gradually decreases the signal level at the end of recording.

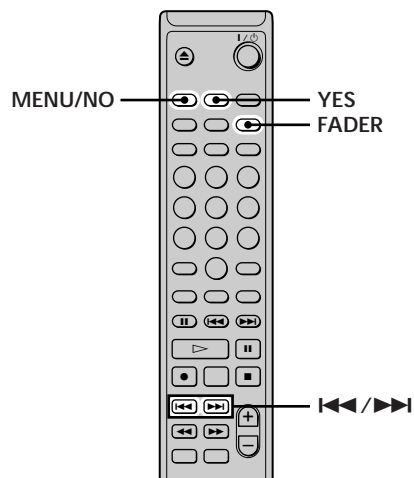

Note

Fade-in Recording and Fade-out Recording have no effect during digital recording.

Fade-in Play and Fade-in Recording

During play pause (for Fade-in Play) or recording pause (for Fade-in Recording), press FADER.

◀ flashes in the display and the deck performs Fade-in Play or Fade-in Recording for five seconds until the counter reaches "0.0s."

Fade-out Play and Fade-out Recording

During play (for Fade-out Play) or recording (for Fade-out Recording), press FADER.

▶ flashes in the display and the deck performs Fade-out Play or Fade-out Recording for five seconds until the counter reaches "0.0s," then pauses.

Falling Asleep to Music

(Sleep Timer)

You can set the deck so that it turns off automatically after 60 minutes.

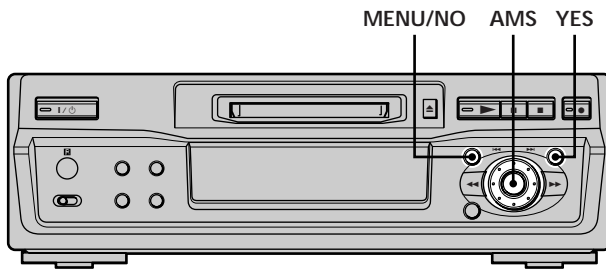

- 1 While the deck is stopped, press MENU/NO twice. "Setup Menu" appears in the display.
- 2 Turn AMS (or press ◀▶ repeatedly) until "Sleep" appears in the display, then press AMS or YES.
- 3 Turn AMS (or press ◀▶ repeatedly) to select the setting, then press AMS or YES.

To	Select
Turn on Sleep Timer	Sleep On
Turn off Sleep Timer	Sleep Off (factory setting)

- 4 Press MENU/NO.

To turn off Sleep Timer

Repeat the procedure above, selecting "Sleep Off" in step 3.

Additional Information

This chapter provides additional information that will help you understand and maintain your MD deck system.

Precautions

On safety

- Should any solid object or liquid fall into the cabinet, unplug the deck and have it checked by qualified personnel before operating it any further.
- The use of optical instruments with this product will increase eye hazard.

On power sources

- Before operating the deck, check that the operating voltage of the deck is identical with your local power supply. The operating voltage is indicated on the nameplate at the rear of the deck.
- The unit is not disconnected from the AC power source (mains) as long as it is connected to the wall outlet, even if the unit itself has been turned off.
- If you are not going to use the deck for a long time, be sure to disconnect the deck from the wall outlet. To disconnect the AC power cord, grasp the plug itself; never pull the cord.
- AC power cord must be changed only at the qualified service shop.

On condensation in the deck

If the deck is brought directly from a cold to a warm location, or is placed in a very damp room, moisture may condense on the lenses inside the deck. Should this occur, the deck may not operate properly. In this case, remove the MD and leave the deck turned on for about an hour until the moisture evaporates.

On the MiniDisc cartridge

- Do not open the shutter to expose the MD.
- Do not place the cartridge where it will be subject to extremes of sunlight, temperature, moisture or dust.

On cleaning

Clean the cabinet, panel and controls with a soft cloth slightly moistened with a mild detergent solution. Do not use any type of abrasive pad, scouring powder or solvent such as alcohol or benzine.

If you have any questions or problems concerning your deck, please consult your nearest Sony dealer.

Handling MDs

The MD is enclosed in a cartridge to protect the disc from debris or fingerprints and to make it easy to handle.

However, the presence of debris or a warped cartridge may inhibit the disc from operating properly. To assure that you can always listen to the highest quality music, follow the precautions below:

- Do not touch the internal disc directly. Forcing the shutter open may damage the internal disc.
- Be sure to stick the labels supplied with the MD to the appropriate positions. The shape of the labels may vary depending on the MD brand.

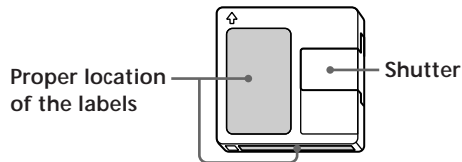

Where to keep the MDs

Do not place the cartridge where it may be exposed to direct sunlight or extremely high heat and humidity.

Regular maintenance

Wipe dust and debris from the surface of the cartridge with a dry cloth.

System Limitations

The recording system in your deck is radically different from those used in cassette and DAT decks and is characterized by the limitations described below. Note, however, that these limitations are due to the inherent nature of the MD recording system itself and not to mechanical causes.

“Disc Full” appears in the display even before the MD has reached the maximum recording time (60 or 74 minutes)

When 255 tracks have been recorded on the MD, “Disc Full” appears regardless of the total recorded time. More than 255 tracks can’t be recorded on the MD. To continue recording, erase unnecessary tracks or use another recordable MD.

“Disc Full” appears before the maximum number of tracks is reached

Fluctuations in emphasis within tracks are sometimes interpreted as track intervals, incrementing the track count and causing “Disc Full” to appear.

The remaining recording time does not increase even after erasing numerous short tracks
Tracks under 12 seconds in length are not counted and so erasing them may not lead to an increase in the recording time.

The total recorded time and the remaining recordable time on the MD may not total the maximum recording time (60 or 74 minutes)
Recording is done in minimum units of 2 seconds each, no matter how short the material. The contents recorded may thus be shorter than the maximum recording capacity. Disc space may also be further reduced by scratches.

Limitations when recording over an existing track

- The correct remaining recordable time may not be displayed.
- You may find it impossible to record over a track if that track has been recorded over several times already. If this happens, erase the track (see page 29).
- The remaining recordable time may be shortened out of proportion to the total recorded time.
- Recording over a track to eliminate noise is not recommended since this may shorten the duration of the track.
- You may find it impossible to name a track while recording over an existing track.

Tracks created through editing may exhibit sound dropout as you’re searching for a point while monitoring the sound.

Some tracks can’t be combined with others
Tracks may not be combined if they have been edited.

Track numbers are not marked correctly
Incorrect assignment or marking of track numbers may result when CD tracks are divided into several smaller tracks during digital recording. Also, when the Automatic Track Marking is activated during recording, track numbers may not be marked as in the original, depending on the program source.

“TOC Reading” appears for a long time
If the inserted recordable MD is brand new, “TOC Reading” appears in the display longer than for MDs that have already been used.

The correct recorded/playing time may not be displayed during playback of MDs recorded in monaural mode.

Troubleshooting

If you experience any of the following difficulties while using the deck, use this troubleshooting guide to help you remedy the problem. Should any problem persist, consult your nearest Sony dealer.

The deck does not operate or operates poorly.

- ➔ The MD may be dirty or damaged. Replace the MD.
- ➔ Only I/⏻ and INPUT are operable while the MD deck is being controlled by a personal computer.

The deck does not play.

- ➔ Moisture has formed inside the deck. Take the MD out and leave the deck in a warm place for several hours until the moisture evaporates.
- ➔ The deck is not on. Press I/⏻ to turn the deck on.
- ➔ The deck may not be connected to the amplifier correctly. Check the connection.
- ➔ The MD is inserted in the wrong direction. Slide the MD into the disc slot with the label side up and the arrow pointing towards the slot.
- ➔ The MD may not be recorded. Replace the disc with one that has been recorded.

The sound has a lot of static.

- ➔ Strong magnetism from a television or a similar device is interfering with operations. Move the deck away from the source of strong magnetism.

The deck does not record.

- ➔ The MD is record-protected. Slide the record-protect tab and close the slot.
- ➔ The deck is not connected properly to the program source. Check the connection.
- ➔ Select the correct program source using INPUT.
- ➔ The recording level is not adjusted properly. Adjust the recording level.
- ➔ A premastered MD is inserted. Replace it with a recordable MD.
- ➔ There is not enough time left on the MD. Replace it with another recordable MD with fewer recorded tracks, or erase unnecessary tracks.
- ➔ There has been a power failure or the AC power cord has been disconnected during recording. Data recorded to that point may be lost. Repeat the recording procedure.

The deck does not perform Synchro-recording with a CD player or video CD player.

- ➔ The remote supplied with the MD deck is not set correctly. Reset the remote.

A message and a three-digit alphanumeric code alternate in the display.

- ➔ The Self-Diagnosis Function is on. See the table on page 44.

Note

If the deck does not operate properly even after you've attempted the prescribed remedies, turn off the deck, then reinsert the plug into the power outlet.

Specifications

System	MiniDisc digital audio system
Disc	MiniDisc
Laser	Semiconductor laser ($\lambda = 780 \text{ nm}$) Emission duration: continuous
Laser output	Less than $44.6 \mu\text{W}^*$ * This output is the value measured at a distance of 200 mm from the objective lens surface on the Optical Pick-up Block with 7 mm aperture.
Laser diode	Material: GaAlAs
Revolutions (CLV)	400 rpm to 900 rpm
Error correction	Advanced Cross Interleave Reed Solomon Code (ACIRC)
Sampling frequency	44.1 kHz
Coding	Adaptive Transform Acoustic Coding (ATRAC)
Modulation system	EFM (Eight-to-Fourteen Modulation)
Number of channels	2 stereo channels
Frequency response	5 to 20,000 Hz $\pm 0.3 \text{ dB}$
Signal-to-noise ratio	Over 94 dB during playback
Wow and flutter	Below measurable limit
Inputs	
LINE (ANALOG) IN	Jack type: phono Impedance: 47 kilohms Rated input: 500 mVrms Minimum input: 125 mVrms
DIGITAL IN	Connector type: square optical Impedance: 660 nm (optical wave length)
Outputs	
LINE (ANALOG) OUT	Jack type: phono Rated output: 2 Vrms (at 50 kilohms) Load impedance: Over 10 kilohms

General

Power requirements

Where purchased	Power requirements
U.S.A. and Canada	120 V AC, 60 Hz
U.K., Continental Europe, and Argentina	220 - 230 V AC, 50/60 Hz
Australia	240 V AC, 50/60 Hz
Certain countries in Asia	220 - 240 V AC, 50/60 Hz
Brazil	127 or 220 V AC, 60 Hz
Other countries	110 - 120 or 220 - 240 V AC selectable, 50/60 Hz

Power consumption 15 W

Dimensions (approx.) 280 × 90 × 285 mm (11 ¹/₈ × 3 ⁵/₈ × 11 ¹/₄ inches) (w/h/d) incl. projecting parts and controls

Mass (approx.) 3.0 kg (6 lb 8 oz)

Supplied accessories

See page 4.

Optional accessories

Recordable MDs MDW-60 (60 min), MDW-74 (74 min)

US and foreign patents licensed from Dolby Laboratories Licensing Corporation.

Design and specifications are subject to change without notice.

Display Messages

The following table explains the various messages that appear in the display. Messages are also displayed by the deck's Self-Diagnosis function (see page 44).

Message	Meaning
Auto Cut	The Auto Cut function is on (page 17).
Blank Disc	A new (blank) or erased MD has been inserted.
Cannot Copy	An attempt was made to make a second copy from a digitally dubbed MD (page 14).
Cannot Edit	An attempt was made to edit the MD during Program or Shuffle Play. Or the MD is record-protected.
Disc Full	The MD is full (page 40).
Impossible	The deck cannot do the specified operation.
Initialize (flashing)	The Setup Menu settings have been lost.
Name Full	The naming capacity of the MD has reached its limit (about 1,700 characters).
No Disc	There is no MD in the deck.
No Name	The track or disc has no name.
No Program!!	You tried to start Program Play when no program exists.
Premastered	An attempt was made to record on a premastered MD.
ProgramFull!	The program contains the maximum number of tracks. You cannot add any more tracks.
REMOTE	The MD deck is being controlled by an external device connected to the deck.*
Smart Space	The Smart Space function is on (page 17).
TOC Reading	The deck is checking the TOC (Table Of Contents) on the MD.

* If "REMOTE" appears under other circumstances, turn off the deck, then turn it on again.

Edit Menu Table

The following table provides a quick guide to the various editing functions that you can perform using the Edit Menu.

To access the Edit Menu

Press MENU/NO to display “Edit Menu.”

Note

The available menu items may vary according to the current status of the deck.

Menu item	Sub-item	Function	Reference page(s)
Tr Erase ?	—	Erases a track.	29
All Erase ?	—	Erases all the tracks on an MD.	30
A-B Erase ?	—	Erases a portion of a track.	30
Divide ?	—	Divides a track.	31
Combine ?	—	Combines tracks.	32
Move ?	—	Moves a track.	32
Name ?	Nm In ?	Names a track or an MD.	33
	Nm Copy ?	Copies a name to a track or an MD.	34
	Nm Erase ?	Erases a name.	35
	Nm All Ers ?	Erases all the names on an MD.	35
Undo ?	—	Undoes the last edit operation.	36
Setup ?	—	Enters Setup Menu (page 44) directly.	—

Setup Menu Table

The following table provides an overview of the various Setup Menu items, including their parameters, factory settings, and reference page(s) in the manual.

To access the Setup Menu

While the deck is stopped, press MENU/NO twice to display "Setup Menu."

Menu item	Function	Parameters	Factory setting	Reference page(s)
Program ?	Creates a program.	—	—	25
T.Mark	Turns Automatic Track Marking on or off.	Off/LSync	LSync	17
LS(T)	Changes the trigger level for Automatic Track Marking.	-72 to 0dB*	-50 dB	18
Auto	Turns Auto Space and Auto Pause on or off.	Off/Space/Pause	Off	26, 27
S.Space	Turns Smart Space and Auto Cut on or off.	On/Off	On	17
P.Hold	Continuously displays the level of the strongest signal.	On/Off	On	16
Sleep	Turns the Sleep Timer function on or off.	On/Off	Off	38
Rec	Selects the recording mode.	Stereo/Mono	Stereo	14

* Adjustable in 2 dB steps.

To recall a factory setting

Press CLEAR while selecting the parameter.

Self-Diagnosis Function

The deck's self-diagnosis function automatically checks the condition of the MD deck when an error occurs, then issues a three-digit code and an error message on the display. If the code and message alternate, find them in the following table and perform the indicated countermeasure. Should the problem persist, consult your nearest Sony dealer.

Three-digit code/Message	Cause/Remedy
C11/Protected	The inserted MD is record-protected. ➔ Take out the MD and close the record-protect slot (page 15).
C13/REC Error	The recording was not made properly. ➔ Set the deck in a stable surface, and repeat the recording procedure. The inserted MD is dirty (with smudges, fingerprints, etc.), scratched, or substandard in quality. ➔ Replace the disc and repeat the recording procedure.
C13/Read Error	The deck could not read the TOC on the MD properly. ➔ Take out the MD and insert it again.
C14/TOC Error	The deck could not read the TOC on the MD properly. ➔ Insert another disc. ➔ If possible, erase all the tracks on the MD (page 30).
C71/Din Unlock	The sporadic appearance of this message is caused by the digital signal being recorded. This will not affect the recording. While recording from a digital component connected through the DIGITAL IN connector, the digital connecting cable was unplugged or the digital component turned off. ➔ Connect the cable or turn the digital component back on.

Using the Beeps

The deck can output various beeps that allow you to identify deck operations by sound. The beeps are output from the LINE (ANALOG) OUT jacks.

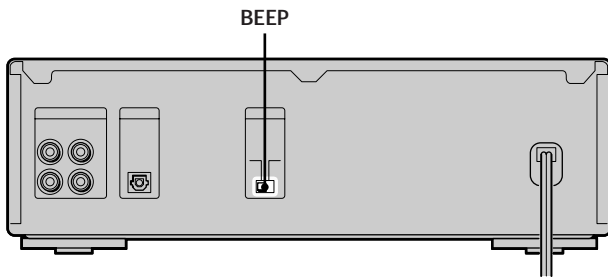

Set BEEP to ON.

Beeps are output according to the deck status as follows:

- **One short beep (high)**
The deck has been turned on, started playing, started recording,* etc.
- **One short beep (low)**
 - The deck has stopped or the MD has been ejected.
 - Menu operation has finished or canceled, normal play mode has been resumed, recording level has been set to 0 dB (default value) (i.e., the deck has resumed the normal status).
- **Several beeps (low and high beeps are output alternately)**
The deck's self diagnosis function has been activated and a code and message alternate in the display.
- **Consecutive beeps (high)**
 - An operation button was pressed with no MD inserted.
 - An attempt was made to edit a record-protected MD.
- **Consecutive beeps (low)**
The recording level or trigger level for Automatic Track Marking has been set to maximum or minimum.
- **One continuous beep (high)**
 - was pressed but the MD is full.
- **One continuous beep (low)**
During recording or recording pause, the peak level meters have exceeded the recommended level ("OVER" lights up).*
- **Consecutive short beeps (low)** followed by single short beeps (low) every few seconds**
The deck has changed to recording pause.

* The beep has no effect on recording results.

**One low beep for each 10 minutes of remaining recordable time (e.g., one beep for 11 to 20 minutes, two beeps for 21 to 30 minutes, and three beeps for 31 to 40 minutes). No beep is output for a remaining time of 10 minutes or less.

To turn off the beeps

Set BEEP to OFF.

 You can identify the current recording mode by its sound. Press SCROLL while the deck is stopped and an MD is inserted. Different beeps are emitted for each recording mode as follows:

When the recording mode is set to	The deck emits
Stereo	Consecutive beeps (high)
Monaural	One short beep (high)

Note

If you press SCROLL while BEEP is set to ON and no MD is inserted, a beep is emitted and the status of the following items automatically changes as follows:

- Shuffle Play or Program Play is canceled and normal play is resumed.
- Repeat All Play or Repeat 1 Play is canceled.
- The recording mode is set to stereo mode.

Index

A

- Accessories
 - optional 42
 - supplied 4
- AMS 22
- Audio connecting cord 4, 5
- Auto Cut 17
- Auto Pause 27
- Auto Space 26
- Automatic Track Marking
 - additional information 18
 - how to 17
 - trigger level 18

B

- Battery 4
- Beeps 45
- Blank
 - erasing during recording. *See Smart Space and Auto Cut*
 - inserting during play. *See Auto Space*

C

- CD Synchro-recording 19
- Combining 32

D

- De-emphasizing 14
- Displaying
 - disc name 11, 12
 - remaining recordable time 12
 - total number of tracks 11, 12
 - total recorded time 11, 12
 - track name 12
- Dividing
 - after selecting the point 31
 - after selecting the track 31

E

- Erasing
 - a name 35
 - a portion of a track 30
 - a track 29
 - all names 35
 - all tracks 30

F, G, H

- Fade-in
 - Play 37
 - Recording 37
- Fade-out
 - Play 37
 - Recording 37

I, J, K

- Input Monitor 16

L

- Level
 - input signal 12
 - recording 16
- Locating
 - particular point 23
 - tracks 22

M

- Manual Track Marking 17
- MD (MiniDisc)
 - ejecting 15, 21
 - premastered 12
 - recordable 12, 14
 - record-protect tab 15
- Monitoring input signal. *See Input Monitor*
- Moving 32
- Music Synchro-recording 19

N

- Naming
 - copying 34
 - how to 33, 34
 - renaming 35

O

- Optical cable 4, 5

P, Q

- Pausing
 - after each track. *See Auto Pause*
 - play 21
 - recording 15
- Peak Hold 16
- Peak level meters 16
- Playing
 - entering the number 22
 - from the first track 21
 - specific track. *See Locating*
- Program Play
 - changing the contents 26
 - checking the contents 25
 - programming 25

R

- Recording
 - how to 14, 15
 - mode 14
 - over existing tracks 15
- Remote 4
- Repeat A-B Play 24
- Repeat All Play 23
- Repeat 1 Play 24
- Repeating
 - a portion. *See Repeat A-B Play*
 - all tracks. *See Repeat All Play*
 - current track. *See Repeat 1 Play*

S

- Sampling rate converter 14
- SCMS. *See Serial Copy Management System*
- Scrolling the name 12
- Serial Copy Management System 14
- Shuffle Play 24
- Sleep Timer 38
- Smart Space 17

T

- Table of contents. *See TOC*
- Time Machine Recording 18
- TOC 13, 29

U, V, W, X, Y, Z

- Undoing 36

