

JVC

PORTABLE MINIDISC PLAYER

ENGLISH



INSTRUCTIONS

LVT0487-001A [E]

Supplied Accessories

Check the packing carton for these accessories.

AC adaptor (AA-R9017)	1 pc.	Rechargeable nickel metal hydride battery (BN-R1210)	1 pc.
Headphones	1 pc.	Dry-cell battery case	1 pc.
Wired remote control	1 pc.	Carrying pouch	1 pc.
Charger/adaptor (AC-R124)	1 pc.		

*Use numbers indicated in parentheses when asking for replacement parts.

Thank you for purchasing this JVC product. Please read these instructions carefully before starting operation to be sure to obtain optimum performance and a longer service life from your minidisc player.

CAUTION!

THIS PRODUCT UTILIZES A LASER. USE OF CONTROLS OR ADJUSTMENTS OR PERFORMANCE OF PROCEDURES OTHER THAN THOSE SPECIFIED HEREIN MAY RESULT IN HAZARDOUS RADIATION EXPOSURE. DO NOT OPEN COVERS AND DO NOT REPAIR YOURSELF. REFER SERVICING TO QUALIFIED PERSONNEL.

WARNING:

TO REDUCE THE RISK OF FIRE OR ELECTRIC SHOCK, DO NOT EXPOSE THIS APPLIANCE TO RAIN OR MOISTURE.

CAUTION:

AC adaptor (AA-R9017), Charger/Adaptor (AC-R124) and rechargeable Ni-MH battery (BN-R1210 and BN-R127) are audio equipments for XM-PX5 only.



- CLASS 1 LASER PRODUCT
- DANGER:** Invisible laser radiation when open and interlock failed or defeated. Avoid direct exposure to beam.
- CAUTION:** Do not open the top cover. There are no user serviceable parts inside the Unit; leave all servicing to qualified service personnel.

WARNING LABEL, PLACED INSIDE THE UNIT

DANGER: Invisible laser radiation when open and interlock failed or defeated. AVOID DIRECT EXPOSURE TO BEAM. (e)

VARNING: Osynlig laserstrålning när denna del öppnas och spärren är urkopplad. Beträkta ej strålen. (s)

ADVARSEL: Usynlig laserstrålning ved åbning, når sikkerhedsafbrydere er ude af funktion. Undgå udsættelse for stråling (d)

VARO: Avattaessa ja suo-jälukitus ohitettaessa olet alttiina näkymättömälle lasersäteilylle. Älä katso säteeseen. (f)

Power Supply Preparations

Using the rechargeable Ni-MH battery (included)

- Remove the rechargeable battery from its case.
- Insert the rechargeable battery into the charger/adaptor.

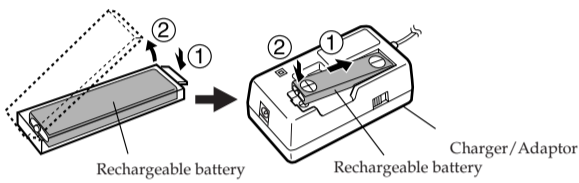

- Set the switch on the charger/adaptor to "CHARGER".
- Connect the AC adaptor to the charger/adaptor.

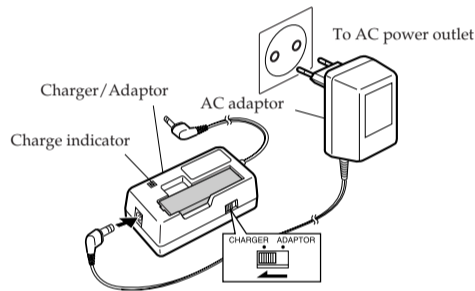

- The charge indicator will initially light red. It will go out when recharging is completed. When recharging is complete, unplug the AC adaptor from the AC outlet and the charger/adaptor.
- Remove the recharged battery from the charger/adaptor and insert it into the minidisc player.

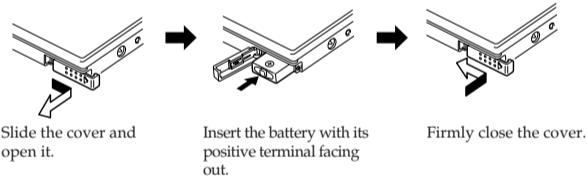

Notes:

- You cannot use the MD player while charging the rechargeable battery.
 - It takes approximately 2 hours to recharge the rechargeable battery.
 - The rechargeable battery has a service life of approximately 300 charge-discharge cycles. If the operating time on one full charge becomes noticeably shorter than it used to be, the battery has reached the end of its service life and should be replaced.
 - The AC adaptor and rechargeable battery may become warm while recharging. This is not a malfunction.
 - When recharging the rechargeable battery which was left unused for a long time, the charge indicator may not light immediately. It will light in a few minutes.
- Refer to the specifications for information on operating time durations when using a rechargeable battery, dry-cell battery, a or both together.

Using the AC adaptor

CAUTION: "Be sure there is no battery in the minidisc player or in the dry-cell battery case."

- Attach the battery case to the minidisc player.

Turn the knob on the battery case toward "LOCK" until it stops. (To detach the battery case, turn the knob toward "RELEASE" until the battery case comes loose.)

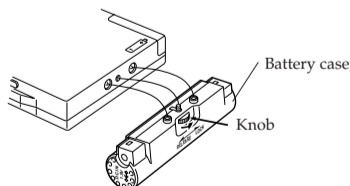

- Set the switch on the charger/adaptor to "ADAPTOR".

- Connect the AC adaptor to the charger/adaptor, and the charger/adaptor to the battery case.

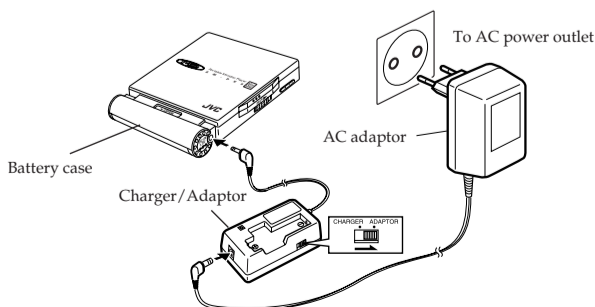

Notes:

- The minidisc player is in a standby mode when the AC adaptor and charger/adaptor are connected.
- The primary circuit is "live" as long as the AC adaptor is connected to an electrical outlet.

Using a dry-cell battery (not included)

CAUTION: Do not use a dry-cell battery together with the AC adaptor.

- Open the lid of the battery case and insert a LR6 (UM-3) alkaline battery into the battery compartment.
- Attach the battery case to the minidisc player. (See "Using the AC adaptor".)

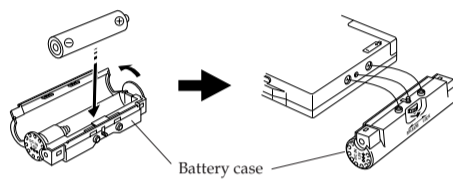

Note:

- To lengthen battery life, you can use both the rechargeable battery and a dry-cell battery at the same time.

Accidental Operation Prevention Function (Hold Mode)

This function prevents the minidisc player from operating accidentally. Both the minidisc player and the remote control have HOLD switches, each of which works independently.

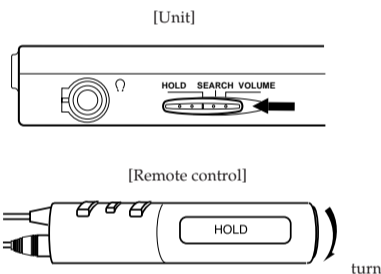

Rotate the remote control switch in the direction shown by the arrow to activate the HOLD mode.

When the minidisc player is in HOLD mode, no button operation is possible for either the minidisc player unit or its remote control.

To operate the minidisc player or remote control normally, switch off the HOLD mode.

Note:

- When HOLD is released on the remote control, "HELLO" will be displayed in the display windows, and the music number and its play time will be displayed.

Cautions

Batteries

- Before replacing batteries, always turn the minidisc player off.

Rechargeable Ni - MH battery :

- Use only the rechargeable battery BN-R1210 (supplied) or BN-R127 (not supplied) with this minidisc player.
- If the power delivered by the battery lasts for a very short time after recharging, it means that the battery's service life is over. Do not use it any more.
- Recharging an already charged battery will shorten its service life.
- When recharging a battery for the first time, or when it has not been used for a long period of time, the play time may be shorter than usual. In a case like this, repeatedly recharge and discharge the battery. This will restore it to its regular state.
- Do not allow any metal objects to touch the terminals of the rechargeable battery because this may cause dangerous short-circuiting.
- Recharge the battery at a temperature of 10°C to 35°C.

Dry cell battery and rechargeable battery:

To prevent damage to the batteries, and to avoid electrolyte leakage, heed the following instructions.

- Align the ⊕ and ⊖ polarities properly when inserting the batteries.
- Remove the batteries if you do not plan to use the minidisc player for a long period of time.
- Do not expose the batteries to open flame, and do not short-circuit, disassemble, or subject them to excessive heat.
- Do not attempt to recharge dry cell batteries.

Carrying batteries:

- When putting dry cell or rechargeable batteries in a pocket or bag, ensure that no other metal objects, such as necklaces or coins, are placed together with them. Contact with metal may cause short-circuiting which, in turn, may cause a fire.
- Be absolutely sure to carry the rechargeable battery in the battery carrying case.

Recycling Notice

The rechargeable battery is designated recyclable. Please follow your local recycling regulations.

AC adaptor and charger/adaptor

- Handle the AC adaptor and charger/adaptor carefully. Improper handling is dangerous.
 - Do not touch them with wet hands.
 - Do not place heavy objects on top of them.
 - Do not forcibly bend them.
- Be sure to use only the AC adaptor and charger/adaptor provided with this minidisc player.
- Disconnect the AC adaptor from the power outlet if the unit is not going to be used for a long time.

Location of Controls

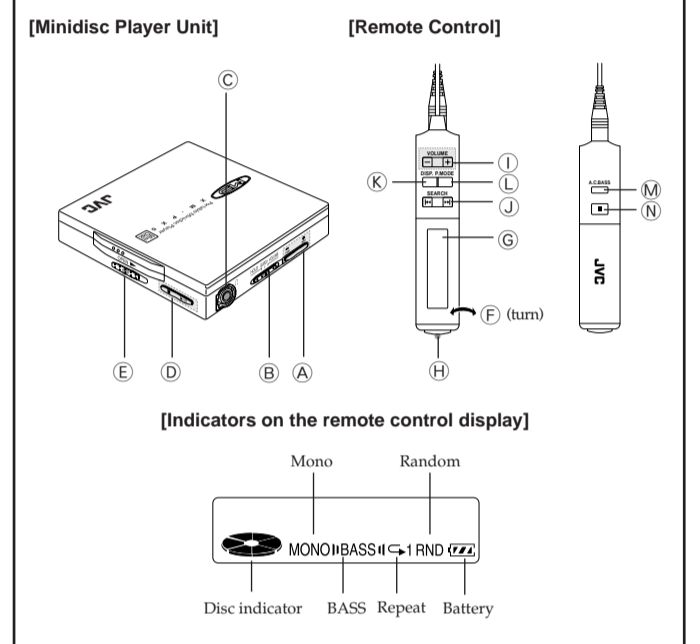

- (A) VOLUME and SKIP / SEARCH button
- (B) HOLD / SEARCH/ VOLUME Mode switch
- (C) Headphones jack (⌚)
- (D) Stop / Play / Pause button (■▶/⏮)
- (E) OPEN switch
- (F) HOLD switch
- (G) Display
- (H) Play / Pause button (▶/⏮)
- (I) VOLUME button (+, -)
- (J) Skip / SEARCH button (⏮▶)
- (K) DISP. (Display) button
- (L) P.MODE (Play mode) button
- (M) A.C.BASS (Active Clear Bass) button
- (N) Stop button (■)

If the rubber holder on the remote control clip comes off

Insert the clip into the rubber holder, then rotate the clip.

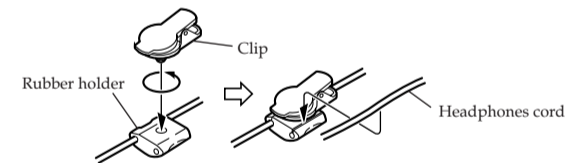

Minidisc Player Unit

- Do not alter or remodel the unit as this can cause malfunctioning.
- Do not alter or impact the unit as this may damage it.
- Avoid using the unit in the following locations since they can cause malfunctioning.
 - Bathrooms and other moisture-prone places.
 - Warehouses and other dusty places.
 - Very hot places near heating appliances, etc.

- Do not leave the unit exposed to direct sunlight for long periods of time as this may deform or discolor the cabinet and may also cause malfunctioning.

Precautions for listening with the headphones

- Do not play your headset at a high volume. Hearing experts advise against continuous extended play.
- If you experience a ringing in your ears, reduce volume or discontinue use.
- Do not use while operating a motorized vehicle. It may create traffic hazard and is illegal in many areas.
- You should use extreme caution or temporarily discontinue use in potentially hazardous situations.
- Even if your headphones are an open-air type designed to let you hear outside sounds, don't turn up the volume so high that you can't hear what's around you.

When driving a car

- In the interest of traffic safety, do not use the minidisc player while driving a vehicle.

Battery Indicator

The battery indicator appears on the remote control display. When the indicator appears as below, power will be shut off a short while after.

Rechargeable battery: Recharge it.

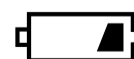

Dry-cell battery: Replace it with new one.

Notes:

- The battery indicator appears when an MD is loaded into the minidisc player.
- The battery indicator also appears when the AC adaptor is used. However, this has no meaning.

Follow the numbers in the figure to the right.

- 1 Connect the headphones plug firmly.**
- 2 Connect the remote control plug firmly.**
- 3 Make sure the switches on the unit and remote control are not on HOLD setting.**
- 4 Load an MD.**
 - Slide the OPEN switch to open the lid.
 - Open the lid by hand.
 - Insert the MD into the MD slot beneath the lid, with its label side facing up. Insert the MD until it stops. Be sure the Δ or \Rightarrow mark on the MD aligns as shown in the figure.
 - Close the lid.
 - "HELLO" appears on the remote control display. Then the track number and playback time appear.
- 5 Adjust the volume level between 0 and 25.**
Press the Volume (+, -) button on the unit or the remote control.
- 6 Press the $\blacktriangleright/\parallel$ button.**
Playback starts from the first track and ends after playing all the tracks on the MD.
Number of tracks being played

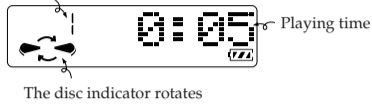
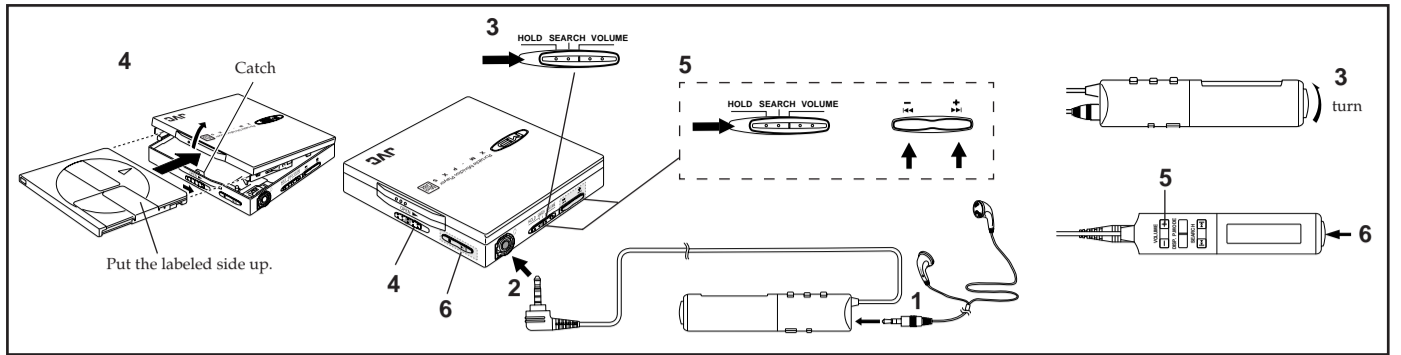

- Notes:**
- Insert the MD in the way that it will not touch the catch. If the catch is bent for some reason, the lid may not be closed properly.
 - When opening the lid, please hold it by the edge when an MD is already loaded.
 - If no MD is loaded, "No Disc" appears on the display, and the power will automatically shut off after approx. 10 seconds.
 - If the MD is recorded in Monaural mode, "MONO" will appear on the display.
 - To eject the MD, slide the OPEN switch and open the lid by hand. The MD will then come out.
 - When the remote control is connected, the power may automatically turn on. However, if left as it is, it will eventually turn off automatically.
 - This MD Player has a 40 second sound-skip-guard memory function to accommodate any shocks. Consequently, it can be used while walking.

Operation	Button	Display/Reference
To pause play	[Unit] or [Remote control] Press during play.	Blinks Press again to restart play. If passed for 2 minutes, the power will automatically shut off.
To stop play (Stop mode)	[Unit] or [Remote control]	Stops Press the $\blacktriangleright/\parallel$ button again to restart play (Resume Play). The current track will be played from the beginning (see "Resume Play"). If stopped for 45 seconds, the power will automatically shut off. When all the music is played, the MD player automatically stops.
To turn off the unit (Off mode)	[Unit] or [Remote control] In play mode, press for 1 second or more.	BYE The power is shut off after "BYE" appears on the display. To turn on the unit, press the $\blacktriangleright/\parallel$ button. (Blank)

Reinforcing the Bass Sound (A.C.BASS)

Press the A.C.BASS button to activate the active clear bass function. The "BASS" indicator appears on the remote control display. The bass level is now automatically controlled in conjunction with the sound volume. Each time you press the A.C.BASS button the playmode changes as follows:

A.C.BASS \rightarrow TRAIN* \rightarrow OFF

* TRAIN mode reduces the amount of sound leaking from the headphone.

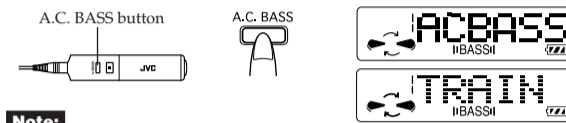

- Note:**
- When the A.C.BASS button is pressed together with the P.MODE button or SEARCH button, the set mode will change. When this happens, set the A.C.BASS mode again.

Resume Play

This function allows you to listen from the beginning of the track on which play was stopped when the minidisc player was set to Stop mode.

Press the $\blacktriangleright/\parallel$ button.

Showing the Disc Information

Each time you press the DISP. button while in Stop mode or during playback, the MD's information is displayed as follows.

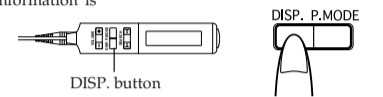

In Stop mode:

Disc title* \rightarrow Total number of tracks and total playback time of the MD \rightarrow Track title* \rightarrow Playback time \rightarrow (back to the beginning)

During Playback:

Playing time \rightarrow Track title* \rightarrow (back to the beginning)

*The disc title or track title will scroll if it consists of 7 characters or more. If no title is given, "—" appears on the display. (Up to 80 characters can be displayed.)

Operation	Button	Display/Reference
Fast forward/Reverse	[Unit] or [Remote control]	<ul style="list-style-type: none"> During Random Play, the skip buttons cannot be used to skip back to tracks that were played previously in the random sequence.
	[Unit] or [Remote control]	

Repeat Play and Random Play

You can select either Repeat Play or Random Play. In Repeat Play, you can repeat all the tracks, or an individual track, as many times as you like. In Random Play, you can play all the tracks in random order.

Selecting Repeat Play and Random Play in Stop mode

In Stop mode, press the P.MODE button. Each time you press the button, the play mode changes as follows:

- \hookrightarrow 1 \rightarrow \hookrightarrow RND \rightarrow \hookrightarrow 1 RND \rightarrow \hookrightarrow RND \rightarrow Original display \rightarrow (back to the beginning)
- \hookrightarrow 1 : Repeats 1 track.
- \hookrightarrow : Repeats all the tracks.
- RND : Random play
- \hookrightarrow 1 RND : Repeats one track randomly selected.
- \hookrightarrow RND : Repeats all the tracks in random order.

After selecting one of the above modes, press the $\blacktriangleright/\parallel$ button.

To exit Repeat Play or Random Play, stop the MD and then press the P.MODE button until the display returns to its original setting.

Repeat Play during Playback

During Normal Play:

Each time you press the P.MODE button, the play mode changes as follows:

\hookrightarrow 1 \rightarrow \hookrightarrow Original display \rightarrow (back to the beginning)

Select " \hookrightarrow 1" to repeatedly play the current track. Select " \hookrightarrow " to repeat all the tracks.

During Random Play:

Each time you press the P.MODE button, the play mode changes as follows:

\hookrightarrow 1 RND \rightarrow \hookrightarrow RND \rightarrow Original display \rightarrow (back to the beginning)

Select " \hookrightarrow 1 RND" to repeatedly play a randomly selected track. Select " \hookrightarrow RND" to repeat all the tracks in random order.

To exit Repeat Play or Random Play, stop the MD and then press the P.MODE button until the display returns to its original setting.

Troubleshooting Guide

Before requesting service for this minidisc player, check the chart below for a possible cause of the problem you are experiencing. Some simple checks, or a minor adjustment on your part, may eliminate the problem and restore proper operation.

If you are in doubt about some of the check points, or if the remedies indicated in the chart do not solve the problem, refer to the directory of Authorized Service Centers (enclosed with this minidisc player), or consult your dealer for instructions.

Problem	Check this
Does not operate.	Is the MD loaded? If unloaded, "No Disc" will appear on the display.
Cannot play the MD.	<ul style="list-style-type: none"> Is the HOLD switch released? Is the battery low? Is there moisture condensation on the lens? (Wait for about an hour and then try again.)
Tracks on MD do not play in order, starting with the first track.	<ul style="list-style-type: none"> Is the Repeat Play or Random Play selected? You stopped or turned off the power while playing. It changed to Resume Play.
Cannot hear music—too noisy.	<ul style="list-style-type: none"> Is the headphone plug inserted all the way? Is the plug dirty? (Wipe away dirt on the plug.) Is music recorded on the MD? If not, "BLANK" will appear on the display.
TV picture is distorted. Radio reception is noisy.	<ul style="list-style-type: none"> Is the unit too near a TV or tuner? (If the TV or tuner is connected to a simple indoor antenna, connect it to an outdoor antenna.)
Power is not turned on.	<ul style="list-style-type: none"> With both HOLD switches activated, the battery was changed during playback. (Release both HOLD switches and try to operate again.)
Charging indicator does not light during charging.	<ul style="list-style-type: none"> Is the charger too hot? (If so, disconnect the AC adaptor and leave the charger for a while.)

MD Messages:

Messages	Meaning	Action
DISC ERROR	There is a problem (damage) with the disc.	Replace the disc.
READ ERROR	Cannot read data.	Remove the MD and reinsert it.

Selecting the Operational Options of Remote Control

Muting the pip tone

When you press a button on the remote control except for the A.C.BASS and VOLUME (+, -) buttons, a pip tone is emitted.

To mute the pip tone, while pressing the A.C.BASS button in Stop mode or during playback, press the P.MODE button. "BEEP OFF" appears on the remote control display.



To resume the pip tone, do the same operation again. "BEEP ON" will appear on the display.

Using the Minidisc Player with Optional Accessories

Using the minidisc player with an audio system

You can listen to MDs through your audio system.

- After turning off the amplifier, plug a stereo connection cable (not supplied) into the headphones jack as shown below.
- Adjust the volume of the minidisc player to an appropriate level.
- Adjust the volume level on the amplifier.
- Use the unit's buttons for operation. (The remote control will issue a Pip tone.)

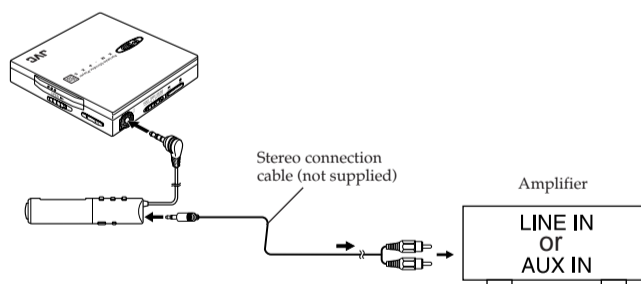

Direct connection without passing through the remote control may generate noise.

Using the minidisc player with a car audio system

You can listen to an MD through your car audio system. The following accessories are available for your car audio system.

- Car adaptor (CA-R153)
- Car audio cassette adaptor

Maintenance

Unit:

Wipe the unit and remote control with a soft cloth. Remove stubborn dirt using a cloth which has been dipped in water (or soapy water) and wrung out. Then wipe them dry.

- If you intend to use a chemically treated cleaning cloth, read its directions first.
- Do not use alcohol or paint thinners.

MDs:

If the MD cartridge is dirty wipe it with a damp cloth and then wipe dry.



When storing MDs, avoid locations which are

- Exposed to direct sunlight.
- Susceptible to high levels of humidity or dust.
- Directly exposed to heat from a heating appliance.
- On top of a car dashboard or near the rear window.

Handling the MDs

- Do not open the shutter. The shutter is usually locked to prevent opening. Do not force in to open, or the disc may be destroyed.

Changing the display character contrast

The character display contrast can be adjusted when the characters become less clear due to ambient temperature or during scrolling.

While pressing the A.C.BASS button in Stop mode or during playback, press the SEARCH button.

Adjustment can be made between LCD00 and LCD15. While the SEARCH button is pressed, the contrast will be changed continuously. The initial setting is "LCD07."

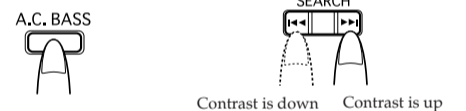

CAUTION: Before connecting the car adaptor, remove the rechargeable battery from the unit and the alkaline battery from the battery case.

- Connect the car adaptor to the battery case as shown below.
- Connect the car audio cassette adaptor to the remote control headphone jack. The other end connects to the cassette slot of your car.
- Adjust the volume level of the unit to an appropriate level.

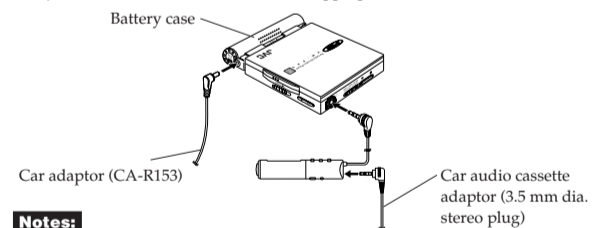

Notes:

- Since the insertion direction of the car audio cassette adaptor is limited, be sure that it can be inserted into the cassette slot of your car audio system.
- Depending on the vehicle used, noise may occur. In this case, it is recommended to connect a noise filter (available on the market) between the remote control and the car audio cassette adaptor.
- If your car audio system is equipped with a LINE IN or AUX IN jack, you can connect the output of the remote control to the jack using a stereo mini plug signal cord (not supplied). In this case, you do not need the optional car audio cassette adaptor.

Specifications

Portable MINIDISC player

- Type : Minidisc digital audio system
- Sampling frequency : 44.1 kHz
- Compression/expansion method : ATRAC method
- Number of channels : 2 channels (stereo)
- Frequency response : 20 Hz to 20,000 Hz
- Wow & flutter : Unmeasurable
- Output : Headphone (3.5 mm dia. stereo x 1)
3 mW/ch at 3% THD/16 ohms to 47 kohms

- Duration of battery : Approx. 21 hours when using a rechargeable battery (BN-R1210) charged for 2 hours ;
Approx. 33 hours when using an alkaline battery (LR6) ;
Approx. 60 hours when using a rechargeable battery and alkaline battery together
* Above duration may differ depending on the ambient temperature and conditions.

- Power requirements : DC 1.2 V (rechargeable battery), DC 1.5 V (R6 size battery)
DC IN 1.5 V

- Dimensions (L x W x H) : 72.0 mm x 15.1 mm x 78.9 mm
(Excluding buttons and controls)
- Mass : Approx. 63 g (without battery)

AC adaptor (AA-R9017)

- Input power source : AC 230 V, 50 Hz
- Output voltage : DC 9 V, 500 mA

Charger/adaptor (AC-R124)

- Input power source : DC 9 V, 0.5 A
- Output voltage : DC 1.5 V, 0.7 A

Design and specifications are subject to change without notice.
US and foreign patents licensed from Dolby Laboratories Licensing Corporation.