

KENWOOD

KMD-42

MD-RECEIVER INSTRUCTION MANUAL

KENWOOD CORPORATION

**Take the time to read through this instruction manual.
Familiarity with installation and operation procedures will help you obtain the
best performance from your new MD-receiver.**

For your records

Record the serial number, found on the back of the unit, in the spaces designated on the warranty card, and in the space provided below. Refer to the model and serial numbers whenever you call upon your KENWOOD dealer for information or service on the product.

Model KMD-42 Serial number _____

© B64-1557-00 (KW)



Contents

Before use

Warning.....	3
Safety precautions	4

General features

Power	6
Volume	6
Attenuator	6
Switching Modes	6
Loudness	7
Audio Control Setting.....	7
Mobile Preset.....	8
Theft Deterrent Faceplate.....	8

Tuner features

Tuning	10
Station Preset Memory	10
Auto Memory Entry	10
Station Name Preset (SNPS)	11
Switching Display for Tuner.....	11

MD/External disc control features

Playing MDs.....	12
Playing Other Disc mode	13
Switching Display for Discs	13
Fast Forwarding and Reversing Disc Play	14
Track Search	14
Disc Search	14
Track / Disc Repeat.....	14
Track Scan.....	15
Disc Scan	15
Random Play	15
Magazine Random Play.....	16
Text / Title Scroll	16
Presetting Disc Names	16

Menu settings

Menu System	18
Touch Sensor Tone	19
Manual Time Adjustment.....	19
Calendar Adjustment	19
Calendar Mode.....	19

Memo Mode	20
Contrast Adjustment.....	20
Switching Graphic Display	21
ec4 (Sound Coordinate system)	21
Clean Reception System Circuit (CRSC).....	21
Text Scroll	21

Installation

Accessories	22
Installation Procedure	22
Connecting Wires to Terminals	23
Installation	24

Troubleshooting Guide27

Specifications31

▲ Warning

▲ CAUTION

Use of controls or adjustments or performance of procedures other than those specified herein may result in hazardous radiation exposure.

In compliance with Federal Regulations, following are reproductions of labels on, or inside the product relating to laser product safety.

KENWOOD CORPORATION
2967-3, ISHIKAWA-CHO,
HACHIOJI-SHI
TOKYO, JAPAN

KENWOOD CORP. CERTIFIES THIS EQUIPMENT
CONFORMS TO DHHS REGULATIONS NO.21 CFR
1040.10, CHAPTER 1, SUBCHAPTER J.

Location : Bottom Panel

FCC WARNING

This equipment may generate or use radio frequency energy. Changes or modifications to this equipment may cause harmful interference unless the modifications are expressly approved in the instruction manual. The user could lose the authority to operate this equipment if an unauthorized change or modification is made.

NOTE

This equipment has been tested and found to comply with the limits for a Class B digital device, pursuant to Part 15 of the FCC Rules. These limits are designed to provide reasonable protection against harmful interference in a residential installation. This equipment may cause harmful interference to radio communications, if it is not installed and used in accordance with the instructions. However, there is no guarantee that interference will not occur in a particular installation. If this equipment does cause harmful interference to radio or television reception, which can be determined by turning the equipment off and on, the user is encouraged to try to correct the interference by one or more of the following measures:

- Reorient or relocate the receiving antenna.
- Increase the separation between the equipment and receiver.
- Connect the equipment into an outlet on a circuit different from that to which the receiver is connected.
- Consult the dealer or an experienced radio/TV technician for help.

NOTE

This Class B digital apparatus complies with Canadian ICES-003.

US and foreign patents licensed from Dolby Laboratories Licensing Corporation.

Safety precautions

⚠WARNING

To prevent injury or fire, take the following precautions:

- Insert the unit all the way in until it is fully locked in place. Otherwise it may fall out of place when jolted.
- When extending the ignition, battery, or ground wires, make sure to use automotive-grade wires or other wires with a 0.75mm² (AWG18) or more to prevent wire deterioration and damage to the wire coating.
- To prevent a short circuit, never put or leave any metallic objects (such as coins or metal tools) inside the unit.
- If the unit starts to emit smoke or strange smells, turn off the power immediately and consult your Kenwood dealer.
- Make sure not to get your fingers caught between the faceplate and the unit.
- Be careful not to drop the unit or subject it to strong shock.

The unit may break or crack because it contains glass parts.

- Do not touch the liquid crystal fluid if the LCD is damaged or broken due to shock. The liquid crystal fluid may be dangerous to your health or even fatal.

If the liquid crystal fluid from the LCD contacts your body or clothing, wash it off with soap immediately.

⚠CAUTION

To prevent damage to the machine, take the following precautions:

- Make sure to ground the unit to a negative 12V DC power supply.
- Do not open the top or bottom covers of the unit.
- Do not install the unit in a spot exposed to direct sunlight or excessive heat or humidity. Also avoid places with too much dust or the possibility of water splashing.
- Do not set the removed faceplate or the faceplate case in areas exposed to direct sunlight, excessive heat, or humidity. Also avoid places with too much dust or the possibility of water splashing.
- To prevent deterioration, do not touch the terminals of the unit or faceplate with your fingers.
- Do not subject the faceplate to excessive shock, as it is a piece of precision equipment.
- When replacing a fuse, only use a new one with the prescribed rating. Using a fuse with the wrong rating may cause your unit to malfunction.
- To prevent a short circuit when replacing a fuse, first disconnect the wiring harness.
- Do not place any object between the faceplate and the unit.
- Do not use your own screws. Use only the screws provided. If you use the wrong screws, you could damage the unit.

IMPORTANT INFORMATION

You cannot connect the unit directly to the following CD automatic changers. If you want to use older changers with the unit, follow the directions below according to the type of changer you own:

• KDC-C200 / KDC-C300 / KDC-C400

Use the extension cable and the control box attached to the CD changer, and the optional CA DS100 converter cord.

• KDC-C301 / KDC-C600 / KDC-C800 / KDC-C601 / KDC-C401

Use the extension cable attached to the CD changer, and the optional CA DS100 converter cord.

• KDC-C100 / KDC-C302 / C205 / C705 / non-Kenwood CD changers

Cannot be used with this model.

⚠CAUTION

You can damage both your unit and the CD changer if you connect them incorrectly.

NOTE

- If you experience problems during installation, consult your Kenwood dealer.
- If the unit does not seem to be working right, try pressing the reset button first. If that does not solve the problem, consult your Kenwood dealer.

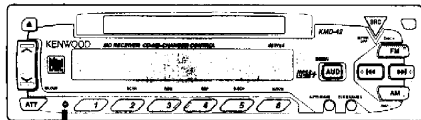

Reset button

- Characters in the LCD may become difficult to read in temperatures below 41 °F (5 °C).
- The illustrations of the display and the panel appearing in this manual are examples used to explain more clearly how the controls are used. Therefore, what appears on the display in the illustrations may differ from what appears on the display on the actual equipment, and some of the illustrations on the display may represent something impossible in actual operation.
- The functions that can be used and the information that can be displayed will differ depending on the external disc players being connected.

Handling Mini discs

- The MD shutter is designed so that it cannot be opened. If forced open, the cartridge will be damaged and use of the MD will no longer be possible. If the shutter has been opened due to some cause, be careful not to touch the recording portion with a finger. Doing so will cause the sound to skip.

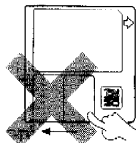

- Do not use an MD that has a peeling label. Use of an MD that has a loose or peeling label may cause problems, such as the label coming off inside the player and the resultant inability to eject the MD.
- Wipe away dirt or dust from the cartridge surface with a dry cloth before use. Using an oil-soiled cartridge in particular may result in the disc not loading or being unable to eject it. (At time of cleaning, be careful not to open the shutter.)
- Do not leave the MD in the unit for a prolonged period. The ejected MD should be placed in an MD case for storage.
- Do not leave the MD in a place exposed to direct sunlight (such as on a dashboard) or in other places that attain high temperatures. The MD cartridge will become misshapen and will no longer be usable.
- MDs designed for use with data cannot be used. Please use MDs designed for music.
- Do not use lens cleaners. Doing so will lead to breakdown.

Cleaning the Faceplate Terminals

If the terminals on the unit or faceplate get dirty, wipe them with a dry, soft cloth.

Cleaning the Unit

If the front panel gets dirty, turn off the power and wipe the panel with a dry silicon cloth or soft cloth.

CAUTION

Do not wipe the panel with a hard cloth or a cloth dampened by volatile solvents such as paint thinner and alcohol. They can scratch the surface of the panel and/or cause the indicator letters to peel off.

Lens Fogging

In cold climates, there may be a period after you turn on your vehicle's heater when the lens that guides the laser beam used in your MD player fogs up. If this happens, you cannot play mini discs. Take out discs and the fogging will disappear. If it does not return to normal after several hours, contact your Kenwood dealer.

General features

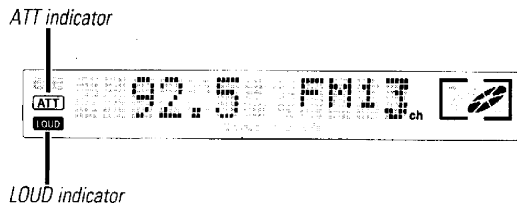
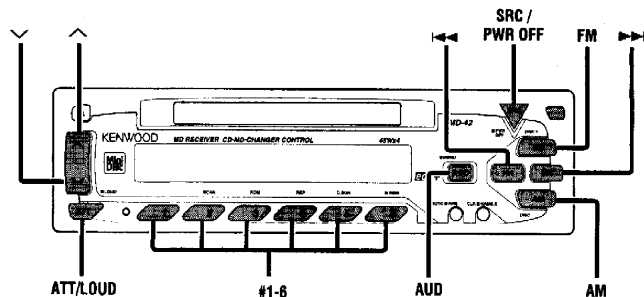

Power

Turning on the power:

Press the SRC (source) button.

NOTE

Turn the power on before carrying out the following procedures.

Turning off the power:

Press the PWR OFF button for at least one second.

Volume

Increasing Volume:

Press the \wedge button to turn up the volume.

Decreasing Volume:

Press the \vee button to turn down the volume.

Attenuator

This function allows you to turn down the volume quickly.

Turning Attenuator On/Off:

Press the ATT button to switch the attenuator on and off.

When the attenuator is on, the ATT indicator blinks.

When the attenuator is off, the volume returns to the original level.

NOTE

Turning the volume up, or turning it all the way down deactivates the attenuator function.

Switching Modes

Switching Modes:

Each time you press the SRC (source) button, the mode

switches as follows:

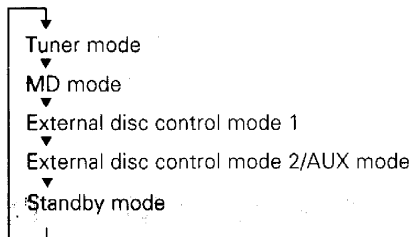

Selecting standby mode:

Press the SRC button repeatedly and switch to "ALL OFF". When "ALL OFF" is displayed, the standby mode is activated. The standby mode turns all functions off while leaving the power to the unit on. Use this mode when you want to have the display illuminated but don't want to listen to anything.

NOTE

- The mode switches to the next mode from any mode which cannot be used.
- The external disc control mode will differ depending on the unit that is connected.
- The AUX mode is available only when the changer / AUX switching adapter (KCA-S210A or CA-C1AX) or CD changer (KDC-CPS85, KDC-CX85, KDC-CPS82 or KDC-CX82) is connected to this unit. During the AUX mode, "AUX" / AUX-name will show in the display. When the CA-C1AX is being used, the AUX Mode will replace the External Disc Control Mode.

NOTE Presetting AUX-name

In the AUX mode, press the NAME.S button for at least two seconds. "NAME SET" is display and AUX-name mode is entered. Input the characters, referring to the section on "Presetting Disc Names (DNPS)" (page 16).

Loudness

This function amplifies low and high tones when the volume is turned down.

The LOUD indicator lights up when the loudness function is on.

Turning Loudness On/Off:

Press the LOUD button for at least one second to switch the loudness on and off.

Audio Control Setting

Adjust various parameters of sound quality.

1 Press the AUD button to enter the control mode.

2 Selecting mode

Press either the FM or AM button.

Each time the button is pressed, the adjustment mode will change.

Please refer to the following for the contents of the adjustment modes.

NOTE Source tone memory

Each source (CD, MD, FM, AM and disc changer) has its own memory in which to store the bass and treble tone settings. The settings made for a particular source are recalled automatically whenever you use that source (for example, FM mode uses the tone settings made for FM, AM for AM, etc.).

3 Adjust each mode

Press the ◀▶ button.

Please refer to the following for the adjusting values.

4 Press the AUD button to end the control mode.

General features

"Bass" : Adjust the bass level.

Setting values: - 8 - + 8

"Treble" : Adjust the treble level.

Setting values: - 8 - + 8

"Balance" : Adjust the balance level.

Setting values: Left 15 - Right 15

"Fader" : Adjust the fader level.

Setting values: Rear 15 - Front 15

"V OFFSET" : Set the sound level of the each source selected by adjusting the level difference between the basic sound level and the required level.

Setting values: - 8 - ± 0

"ec4"/"dB" : Recalling the kenwood preset sound setting

Press the preset buttons (#1-6).

Settings: #1;Flat, #2;Rock, #3;Pops/Top40, #4;Jazz, #5;Easy, #6;Scan of #1-5

NOTE

- This mode is available only when the Sound coordinate system

is on. (page 21)

- You can call the following settings with this function; bass center frequency, bass level, bass quality factor, bass extension, treble center frequency, and treble level setting. Their setting values are different depending on the setting of the mobile preset plan mode.

Mobile Preset

This function allows you to adjust the setting that is recalled with the sound coordinate system, according to types of speakers.

- 1 Press the SRC button repeatedly to select the standby mode. "ALL OFF" is displayed when the standby mode is selected.
- 2 Press the AUD button to enter the mobile preset plan mode.
- 3 Press either the **◀◀** or **▶▶** button to select the type of speaker. The setting switches as follows.
Off / For the OEM speaker / For 6/6x9 in. speaker / For 5/4 in. speaker
- 4 Press the AUD button to end the mobile preset plan mode.

NOTE

- This mode is available only when the Sound coordinate system is on. (page 21)
- When you change the setting of type of speaker, the bass and treble tone settings are returned to original levels.

Theft Deterrent Faceplate

The faceplate of the unit can be detached and taken with you, helping to deter theft.

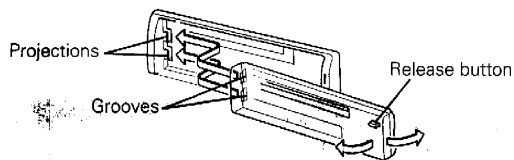

Removing the Faceplate:

Press the release button.

The faceplate is unlocked, allowing you to detach it.

NOTE

- The faceplate is a precision piece of equipment and can be damaged by shocks or jolts. For that reason, keep the faceplate in its special storage case while detached.

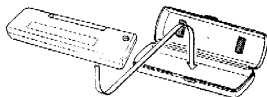

- Do not expose the faceplate or its storage case to direct sunlight or excessive heat or humidity. Also avoid places with too much dust or the possibility of water splashing.

Reattaching the Faceplate:

- 1 Align the projections on the unit with the grooves on the faceplate.
- 2 Push the faceplate in until it clicks.
The faceplate is locked in place, allowing you to use the unit.

Tuner features

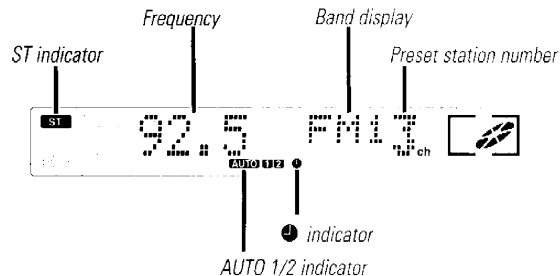
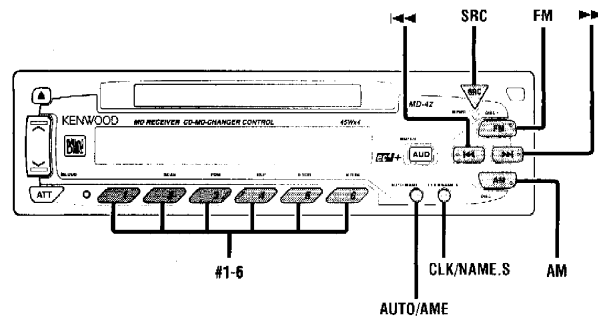

Tuner features

Tuning

You can choose from three tuning modes: auto seek, preset station seek, and manual. The "AUTO 1" indicator lights up when auto seek tuning is selected, and the "AUTO 2" indicator lights when preset station seek tuning is selected.

Selecting Tuning Mode:

Press the AUTO button.

Each time you press the AUTO button, the mode switches as follows.

Auto 1 (Auto Seek Tuning)

Auto 2 (Preset Station Seek Tuning)

Manual (Manual Tuning)

Tuning:

- 1 Press the SRC (source) button repeatedly to select the tuner mode. "TUNER" is displayed when the tuner mode has been selected.
- 2 Press either the FM or AM button to select the band. Each time you press the FM button, the band switches between the FM1, FM2 and FM3 (which are used for groups of preset stations). Press the AM button to select the AM band.
- 3
 - Auto Seek Tuning
Press the ►► button to seek higher frequencies.
Press the ◀◀ button to seek lower frequencies.
 - Preset station seek tuning
Press the ►► button to move to the next preset station (i.e., the one with the next highest number), and the ◀◀ button to move to the last preset station (i.e., the one with the next lowest number).
 - Manual Tuning
Press the ►► button to increase the frequency by one step.
Press the ◀◀ button to decrease the frequency by one step.

NOTE

The ST indicator lights up when stereo broadcasts are being

received.

Station Preset Memory

Store the frequency of a station. You can then recall that station with a single touch of a button.

- 1 Select the band/ station that you want to have stored.
- 2 Press the button (#1-6) that you want to use for the station, for at least two seconds.
The button number blinks once in the display to indicate that the data has been stored.

Recalling a Preset Station:

Press the preset station button (#1-6) for the desired station. The number of the recalled station is displayed.

NOTE

You can store six stations in each of the FM1, FM2, FM3, and AM bands.

Auto Memory Entry

You can automatically store all the receivable frequencies in the band currently being listened to, and then recall them with the touch of a button later. This function is especially useful when you are travelling and do not know what stations are available. Up to six frequencies can be stored this way.

- 1 Select the band for auto memory entry.
- 2 Press the AME button for at least two seconds to start auto memory entry.
The numbers of the preset station buttons are shown in order. When all the stations in a certain band are stored in the preset memory, the auto memory entry stops. The tuner then plays the last station received.

Recalling a Preset Station:

Press the preset station button (#1-6) for the desired station.
The number of the recalled station is displayed.

Station Name Preset (SNPS)

You can assign names to radio stations with the Station Preset Memory. Up to 32 FM stations and 16 AM stations can be assigned names.

- 1 Adjust the frequency to the station whose name you want to enter.

NOTE

The station name preset function cannot be used when a program service name or radio text is displayed.

- 2 Press the NAME.S button for at least two seconds.
"NAME SET" is displayed once the station name preset mode is entered.
The cursor will blink in the position where letters are entered.
- 3 Press either the ◀◀ or ▶▶ button to move the cursor to the desired position.
The ◀◀ button moves the cursor to the left, and the ▶▶ button to the right.
- 4 Each time the AUTO button is pressed, the characters to be entered change as listed below.
Press the FM or AM button to display the desired character.
Characters that can be displayed are as follows.

Alphabet (upper case): A ~ Z

Alphabet (lower case): a ~ z

Numerals and symbols: 0~9 @ " ' ` % & * + - = , . / \ < > []

Special characters: $\text{á à â é ê ì í î ó ô õ ù Ñ Ç Š B i W}$
 $\text{á à â é ê ì í î ó ô õ ù Ñ Ç Š i W}$

- 5 Continue steps 3 and 4 until all the characters are chosen for

the name.

NOTE

You can enter up to 8 characters for each name.

6 Assigning Names

Press the NAME.S button.

The name of the station is stored in memory, and the Station Name Preset mode ends.

Also, if you make no input for 10 seconds, the name will be stored up to the point that you have entered, and the mode ends.

NOTE

- You can assign names to up to 32 FM stations and 16 AM stations.
- All the station names will be erased if you press the RESET button.
- If you want to change the name of a station, first display the name of the station (following steps 1 and 2 above), then change the letter(s) that you want by following steps 3 and 4.

Switching Display for Tuner

You can change the display used when listening to the radio.

Changing the Display:

Each time you press the CLK button, the display changes as follows:

Station frequency

SNPS name (only when being preset)

Clock

Date

MD/External disc control features

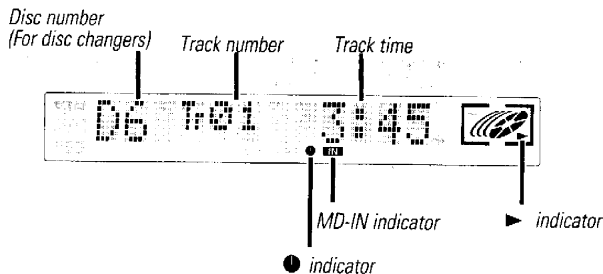
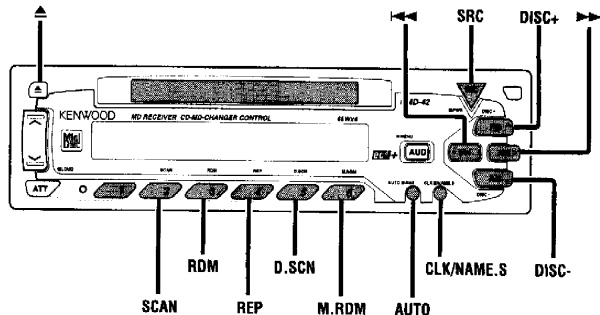

- When a unit equipped with an O-N switch is to be connected, please also see the instruction manual of this unit.

Set the O-N switch to "N". "N"-operation will be set.

"N"-operation:

- The disc title and track title of the CD text can be displayed.
- The disc name will be displayed when the name has been registered to any connected unit with the Presetting Disc Names function, or when the playing unit contains a disc to which the disc title has been recorded.

"O"-operation:

- CD text cannot be displayed.
- Regardless of the control unit, the characters that can be registered with the Presetting Disc Names function are "A~Z 0~9 /, +, -, *, =, <, >, [,]".
- The disc name will be displayed when the name has been registered to the playing unit with the Presetting Disc Names function.

NOTE

The CD text, Presetting Disc Names, and Disc Name Preset Play functions may not be operational depending on the unit.

Playing MDs

Playing MDs:

- If no MDs are inserted, insert one in the slot with the label facing up.
- If an MD is already inserted, press the SRC button repeatedly to select the MD mode.
- "MD" is displayed when the MD mode has been selected.
- The MD will start playing.
- The MD-IN indicator lights up when an MD has been inserted.
- The ► indicator lights up when an MD is being played.

Stopping and Ejecting MDs:

- Press the ▲ button.
- The MD stops playing and ejects from the slot.

CAUTION

Do not attempt to insert an MD into the slot if another one is already there.

Playing Other Disc mode

This function permits the connection of optional players and the playing of discs other than the loaded MD (in the current unit).

Playing Discs:

Press the SRC (source) button repeatedly to select the external disc control mode.

The disc will start playing.

NOTE

The external disc control mode will differ, depending on the unit that is connected.

Mode Display Examples

- "CD" ...when a CD player is connected
- "DISC" ...when a disc changer is connected
- "DISC-1", "DISC-2"....when two disc changers are connected

NOTE

When one disc has finished playing its last track, the next disc in the changer will start playing. When the last disc in the changer has finished, the player will return to the first disc and start playing it.

Switching Display for Discs

Switch the display that appears while discs are playing.

Switching Display for Discs:

Each time you press the CLK button, the display during disc play switches as follows:

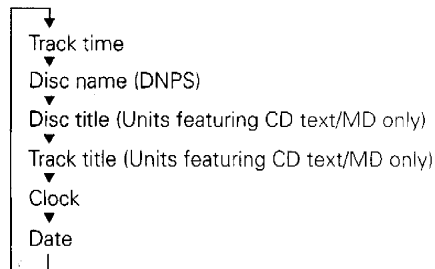

NOTE

- DNPS:Function of disc changers
- You can give names to discs through the presetting disc name function (see p. 16).
Note that depending on the unit, display may not be possible.
- If you try to display the name of a disc that doesn't have one, "NO NAME" is displayed instead.
- When there is an attempt to display the title of a disc for which the disc title/track title has not been recorded, "NO TEXT" is displayed for CD and "NO TITLE/NO NAME" is display for MD.
- Depending on the type of characters of the CD Text, some characters may not be displayable.
- The ● indicator lights while the clock is displayed.

MD/External disc control features

Fast Forwarding and Reversing Disc Play

Fast Forwarding Disc Play:

Hold down on the ►► button.
Release your finger to play the disc at that point.

Reversing Disc Play:

Hold down on the ◀◀ button.
Release your finger to play the disc at the point.

NOTE

You cannot use reverse play between tracks depending on the model being connected. Instead, the reverse play function is canceled when it reaches the beginning of a track, at which point normal play will automatically resume.

Track Search

Search forward or backward through the tracks on the disc until you reach the one that you want to listen to.

Making a Reverse Track Search:

Press the ◀◀ button to display the desired track number.
Press once to search back to the beginning of the current track, twice to search back to the beginning of the previous track, and so forth.
Play starts at the beginning of the displayed track number.

NOTE (For disc changers)

Pressing the ◀◀ button while listening to track 1 will only search back to the beginning of that track. The reverse search is not "recycled" to the last track on the disc.

Making a Forward Track Search:

Press the ►► button to display the desired track number.
Press once to fast forward to the next track, twice to fast forward to the track after that, and so forth.
Play starts at the beginning of the displayed track number.

NOTE (For disc changers)

You cannot make a forward track search when listening to the last track on a disc.

Disc Search

(Function of disc changers)

Search forward or backward through the discs in a disc changer.

Making a Reverse Disc Search:

Press the DISC- button to display the desired disc number.
Each time the button is pressed, the displayed disc number decreases by one.
Play starts at the beginning of the displayed disc.

Making a Forward Disc Search:

Press the DISC+ button to display the desired disc number.
Each time the button is pressed, the displayed disc number increases by one.
Play starts at the beginning of the displayed disc.

NOTE

"LOAD" is displayed when discs are being exchanged on the disc changer.

Track / Disc Repeat

Repeat playing the track or the disc currently being listened to.

Turning Repeat Play On/Off:

Press the REP button to switch repeat track/disc play on and off as follows:

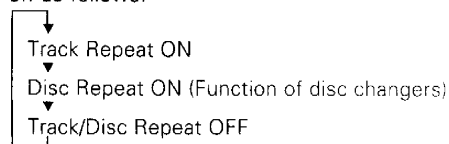

"Repeat/T-Repeat ON" is displayed and the track number blinks in the display when track repeat is on.

"D-Repeat ON" is displayed and the disc number blinks in the display when disc repeat is on.

NOTE

Repeat play is canceled when you eject the disc.

disc changer.

Track Scan

Successively play the beginning of each track on a disc until you find the track that you want to listen to.

Starting the Track Scan:

Press the SCAN button. "Scan/T-Scan ON" is displayed and the first 10 seconds of each track will be played, in order.

The track number currently being heard blinks in the display.

Stopping to Listen to the Track Being Scanned:

Press the SCAN button again to stop the scan and keep on listening to a track normally.

NOTE

- The track scan function is canceled when you eject the disc.
- The track scan function only scans each track on a disc once.

Disc Scan

(Function of disc changers)

Successively play the beginning of each disc on a changer until you find the one that you want to listen to.

Starting the disc scan:

Press the D.SCN button. "D-Scan ON" is displayed and the first 10 seconds of each disc will be played, in the order they are loaded on the changer.

The disc number currently being heard blinks in the display.

Stopping to Listen to the Disc Being Scanned:

Press the D.SCN button again to stop the scan and keep on listening to the disc normally.

NOTE

- The disc scan function is canceled when you eject the disc.
- The disc scan function only scans each disc on the changer once.
- "LOAD" is displayed when discs are being exchanged on the

Random Play

Play all the tracks on the current disc in random order.

- 1 Press the RDM button to switch random play on and off. "Random ON" is displayed when random play is turned on. The track number will change over and over in the display as the next track is being selected. When the track has been selected, play will begin. The selected track number blinks in the display as it is being played.

NOTE (For disc changers)

When all the tracks on a certain disc have been played using random play, the next disc on the changer will start playing using the same function.

- 2 To change the track being heard, press the ►► button. Another track will be selected and played.

NOTE

Random play is canceled when you eject the disc.

MD/External disc control features

Magazine Random Play

(Function of disc changers)

Play the tracks on all the discs in the disc changer in random order.

- 1 Press the M.RDM button to switch magazine random play on and off.
"M-Random ON" is displayed when magazine random play is turned on.
The disc and track numbers will change over and over in the display as the next track is being selected.
When the disc/track has been selected, play will begin.
The selected disc/ track number blinks in the display as it is being played.

NOTE

This function is not available with the following models:
KDC-C200/C300/C400/C301/C401

- 2 To change the track being heard, press the ►► button.
Another disc/track will be selected and played.

NOTE

- Magazine random play is canceled when you eject the disc.
- The time needed for random selection depends on the number of discs loaded in the disc magazine.

Text / Title Scroll

This function permits the text to be scrolled and the entire text to be displayed. The scrolling method differs depending on the setting of scrolling in the menu.

To scroll automatically:

Press the CLK button to display the disc title or the track title.
The display of the text will be scrolled repeatedly.

To scroll manually:

- 1 Press the CLK button to display the disc title or the track title.
- 2 Pressing the CLK button for at least one second results in one scrolling display of the titles.

NOTE

- Please see the menu settings (page 21) about switching between manual scrolling and automatic scrolling.

Presetting Disc Names (DNPS)*(Function of disc changers)*

Store the names of discs to be displayed when played.

- 1 Play the disc whose name you want to preset.

NOTE

- This function is not available for disc changers that do not feature the Disc Name Preset function.
 - This procedure is not to be used to store the disc and track titles for MDs that you record.
 - The disc name preset function cannot be used when a disc title name or track title is displayed.
- 2 Press the NAME.S button for at least two seconds.
"NAME SET" is displayed and the disc name preset mode is entered.
The cursor blinks in the position where character input can be made.
 - 3 Press either the ◀◀ or ►► button to move the cursor to the desired position.
The ◀◀ button moves the cursor to the left, and the ►► button to the right.
 - 4 Each time the AUTO button is pressed, the characters to be entered change as listed below.
Press the DISC+ or DISC- button to display the desired character.
Characters that can be displayed are as follows.

Alphabet (upper case): A ~ Z

Alphabet (lower case): a ~ z

Numerals and symbols: 0~9 @ " ' \ % & * + - = , . / \ < > []

Special characters: á à é ê ì í ó ò ú û ñ ç ß ð ñ ò ó ô õ ö ÷ ù ú û ü ý ÿ ÿ
è ì í ó ô õ ù ñ ç ß ð ñ ò ó ô õ ö ÷ ù ú û ü ý ÿ ÿ

NOTE

The operation and characters that can be entered may change as listed below, depending on the unit that is connected. A press of the AUTO button exits the disc name preset mode. Operations can be followed again from Step 2 at a time such as this, and the characters to be input are selected using the procedure described below.

Press the DISC+ or DISC- button to display the desired character. Besides the alphabet (capital letters only) and numbers, you can choose the following characters: /, +, -, *, =, <, >, [and].

- 5 Continue steps 3 and 4 until all the characters are chosen for the name.

NOTE

You can enter up to eight characters for each name.

- 6 Press the NAME.S button.

The disc name is stored and the disc name preset mode is canceled.

If you make no entry in a 10-second period, the name will be stored with the characters input so far.

NOTE

- The number of characters and discs whose names can be stored will differ depending on the disc changer that is connected. Please see your disc changer manual for details.
- Discs are identified by their total length and number of tracks. If another disc happens to have the same specifications as one that you have already stored a name for, the name will be displayed for it, too.

- If you want to change the name of a disc, repeat steps 1 and 2 to display the name, and then repeat steps 3 and 4 to input the changes.
- Pressing the reset button does not erase the disc names stored in a disc changer.

Menu settings

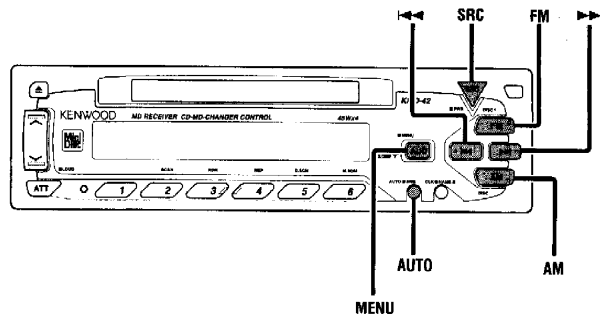

Menu System

You can set the defaults for additional functions in the menu mode. Make a setting for each function, referring to the following operations.

1 Enter the menu mode

Press the MENU button for at least one second. "MENU" is displayed when the menu mode is entered. The function that you can adjust is indicated with the current settings displayed.

2 Selecting function to set

Press the FM button to search through the functions until you see the one you want to adjust in the display. Press the AM button to search through the functions backward.

Example: If you want to switch the setting of the touch sensor tone function from on to off, first search through the functions until you see "Beep ON" in the display.

Beep ON

3 Changing setting for currently displayed function

Press either the ◀◀ or ▶▶ button. The setting will change for each function. Example: The setting of the touch sensor tone will switch from on to off, and "Beep OFF" is displayed.

Beep ON → Beep OFF

4 Ending the menu mode

Press the MENU button.

NOTE

Make sure to end the menu mode when finished.

Touch Sensor Tone

This function produces a beep sound that accompanies button operation. It can be switched on or off.

Display and setting:

- "Beep ON" : Beep setting is on.
- "Beep OFF" : Beep setting is off.

NOTE

The beep sound is not output from the preout jacks.

Manual Time Adjustment

Adjust the time manually.

Display and setting:

- 1 Select the display "Clock Adjust" during the selecting function in the menu system.
- 2 Press either the ◀◀ or ▶▶ button for at least two seconds to enter the Manual time adjustment mode.
The time display will blink.
- 3 • Adjusting the hours
Press the FM button to advance the hours, or press the AM button to make the hours go back.
• Adjusting the minutes
Press the ▶▶ button to advance the minutes, or press the ◀◀ button to make the minutes go back.
- 4 Press the MENU button to end the menu mode.

Calendar Adjustment

Adjust the date for the unit so that you can use the calendar function.

Display and setting:

- 1 Select the display "Date Adjust" during the selecting function in the menu system.
- 2 Press either the ◀◀ or ▶▶ button for at least two seconds to enter the Calendar adjustment mode.
The date display will blink.
- 3 **Selecting the item (day, month, or year) to adjust**
Press the ◀◀ or ▶▶ button.
The item blinking in the display can be adjusted.
- 4 **Adjusting the date**
Press the FM or AM button
The item of the date blinking in the display will change.
- 5 Press the MENU button to end the menu mode.

Calendar Mode

You can set the date formats of the calendar function.

Display and setting:

- 1 Select the display "Date Mode" during the selecting function in the menu system.
- 2 Press the ◀◀ and ▶▶ button to select the date format you want to show in the display.
The sample of the date format for today is displayed.

Menu settings

Memo Mode

You can input the text to be displayed and set the date when that text will appear in the display with the calendar function.

Display and setting:

- 1 Select the display "Memo Mode" during the selecting function in the menu mode.
- 2 Press either the ◀◀ or ▶▶ button for at least two seconds to enter the Memo mode.
The date display will blink.
- 3 **Selecting the set of the date and text to be displayed**
Press the FM and AM button.
If you want to input a new text, select the blank display.
- 4 **Entering the month or day setting mode**
Press the ◀◀ and ▶▶ button to enter the month or day setting mode.
The month display blinks when in month mode, the day display blinks when in day setting mode.
- 5 **Changing the month or day**
Press the FM and AM button.
- 6 **Entering the text input mode**
Press the ▶▶ button to enter the text input mode.
The cursor blinks in the position where character input can be made.
- 7 **Inputting / Changing the text**
 - Moving the cursor
Press the ◀◀ and ▶▶ button.
 - Changing the type of characters
Press the AUTO button.
Each time the button is pressed, the type of characters switches as follows.

Alphabet (upper case): A ~ Z

Alphabet (lower case): a ~ z

Numerals and symbols: 0~9 @ " ' % & * + = ^ \ < > []

Special characters: á à â é ê ì í ò ó ô õ ù ñ ç ð ñ ò ó ô õ ù ñ ç ð ñ ò ó ô õ ù ñ ç ð ñ ò ó ô õ ù ñ ç ð ñ ò ó ô õ ù ñ ç ð ñ

- Selecting the character
Press the FM and AM button.

- 8 Press the MENU button to end the menu mode.

NOTE

- The text you selected automatically appears on the date you set when the unit's power is first turned on. (Calendar function)
the CLK button for at least one second so the display once, regardless of the text scroll setting.
Pressing a button other than the CLK button will cause the text to disappear from the display.
- You can enter up to 32 characters for each text.
- The calendar function can be set up to 30 cases.
- To delete the date and text setting, set both the month and day of the date to "00" or set all of the text to blanks.

Contrast Adjustment

This adjustment permits easy viewing of the display.

Display and setting:

"Contrast 0" – "Contrast 10"

NOTE

The initial setting value is "5".

Switching Graphic Display

You can turn the graphic display on and off.
The initial setting is ON.

Display and setting:

- "Graphic ON" : The graphic display is on.
- "Graphic OFF" : The graphic display is off.

ec4/dB (Sound Coordinate system)

When this system is set to on, the sound coordinate factors (Bass Frequency, Bass quality, Bass extension, and Treble frequency) appear during the audio control mode.

Display and setting:

- "ec4/dB set ON" : The sound coordinate factors appear and can be adjusted.
- "ec4/dB set OFF" : The sound coordinate factors are not appeared.

Clean Reception System Circuit (CRSC)

Temporarily have reception switched from stereo to mono to reduce multi-path noise when listening to the FM station.
The factory default for this function is ON.

Display and setting:

- "CRSC ON" : The CRSC is on.
- "CRSC OFF" : The CRSC is off.

NOTE

Strong electrical fields (such as from power lines) may cause unstable sound quality when CRSC is turned on. In such a situation, turn it off.

Text Scroll

This function permits the CD text and MD title to be scrolled and the entire text to be displayed. Switching between manual scrolling and automatic scrolling is permitted. The factory default is automatic scrolling.







Display and setting:

- "Scroll Auto" : Automatic scrolling
- "Scroll Manu" : Manual scrolling

Accessories

External view

Number of items

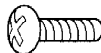
①	1
②	1
③	2
④	1
⑤	4
⑥	4
⑦	1

CAUTION

The use of any accessories except for those provided might result in damage to the unit. Make sure only to use the accessories shipped with the unit, as shown above.

Installation Procedure

1. To prevent a short circuit, remove the key from the ignition and disconnect the ⊖ battery.
2. Make the proper input and output wire connections for each unit.
3. Connect the speaker wires of the wiring harness.
4. Connect the wiring harness wires in the following order: ground, battery, ignition.
5. Connect the wiring harness connector to the unit.
6. Install the unit in your car.
7. Reconnect the ⊖ battery.
8. Press the reset button.

CAUTION

- If your car's ignition does not have an ACC position, connect the ignition wires to a power source that can be turned on and off with the ignition key. If you connect the ignition wire to a power source with a constant voltage supply, as with battery wires, the battery may die.
- If the console has a lid, make sure to install the unit so that the faceplate will not hit the lid when closing and opening.
- If the fuse blows, first make sure the wires aren't touching to cause a short circuit, then replace the old fuse with one with the same rating.
- Do not let unconnected wires or terminals touch metal on the car or anything else conducting electricity. To prevent a short circuit, do not remove the caps on the ends of the unconnected wires or the terminals.
- Connect the speaker wires correctly to the terminals to which they correspond. The unit may be damaged or fail to work if you share the ⊖ wires or ground them to any metal part in the car.
- After the unit is installed, check whether the brake lamps, blinkers, wipers, etc. on the car are working properly.
- Insulate unconnected wires with vinyl tape or other similar material.
- Some disc changers need conversion cords for connection. See the section on "Safety Precautions" for details.
- Mount the unit so that the mounting angle is 30° or less.

Connecting Wires to Terminals

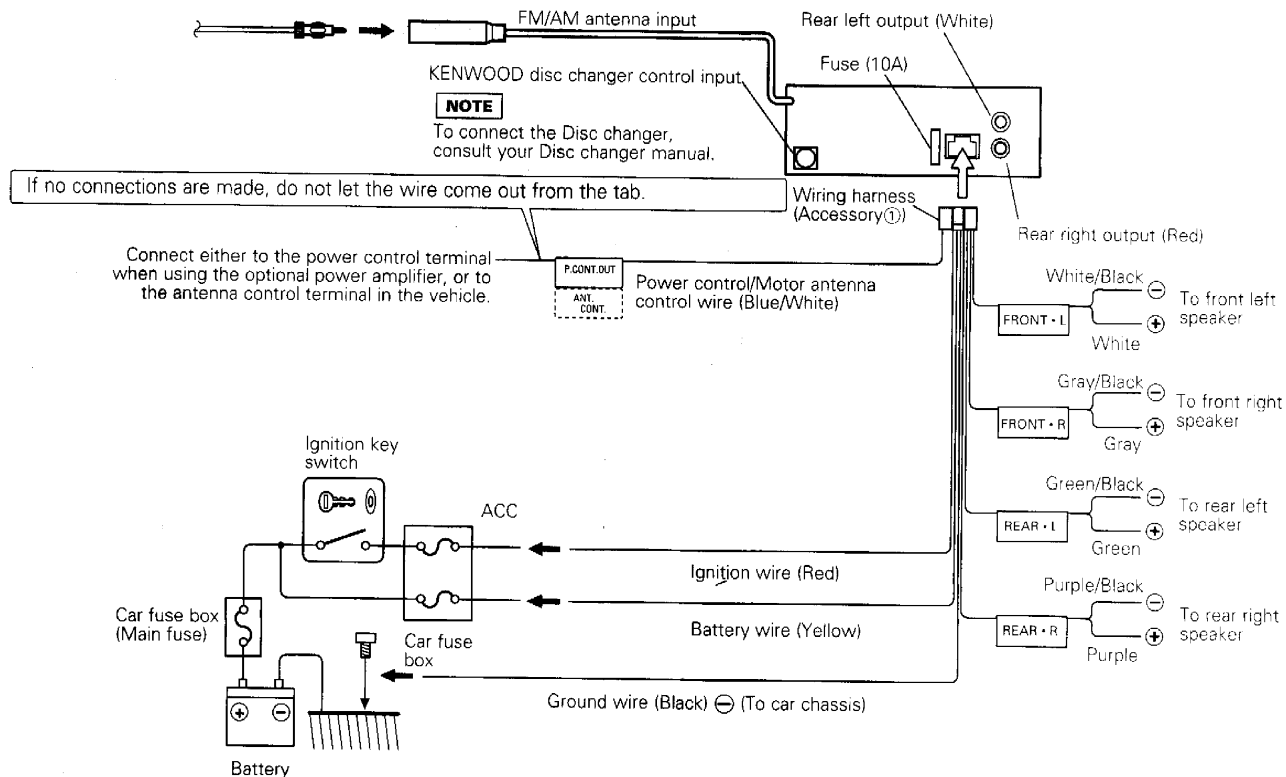

⚠ WARNING

If you connect the ignition wire (red) and the battery wire (yellow) to the car chassis (ground), you may cause a short circuit, that in turn may start a fire. Always connect those wires to the power source running through the fuse box.

⚠ CAUTION

When only two speakers are being connected to the system, connect the connectors either to both the front output terminals or to both the rear output terminals (do not mix front and rear). For example, if you connect the ⊕ connector of the left speaker to a front output terminal, do not connect the ⊖ connector to a rear output terminal.

■ Installation

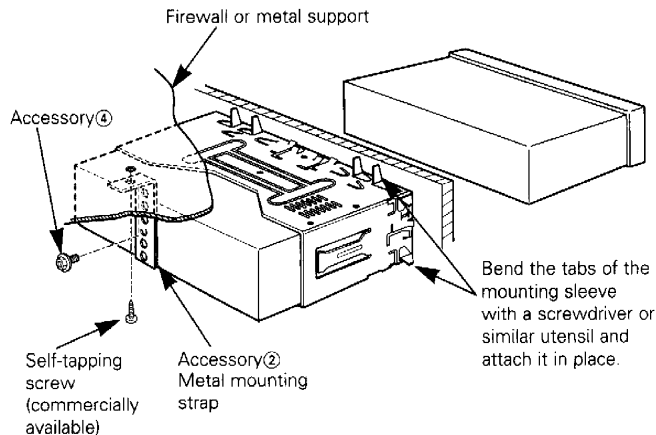

NOTE

Make sure that the unit is installed securely in place. If the unit is unstable, it may malfunction (for example, the sound may skip).

■ Installing in Japanese-Made Cars

- 1 Refer to the section "Removing the hard rubber frame (P. 25)" and then remove the hard rubber frame.
- 2 Align the holes in the unit (two locations on each side) with the vehicle mounting bracket and secure the unit with the accessory screws.

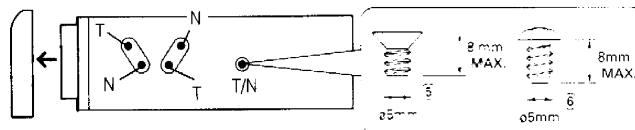

CAUTION

- During installation, do not use any screws except for those provided. The use of different screws might result in damage to the main unit.
- Damage may occur if a screwdriver or similar tool is used with excessive force during the installation.

■ Removing the hard rubber frame

- 1 Engage the catch pins on the removal tool and remove the two locks on the lower level.
Lower the frame and pull it forward as shown in the figure.

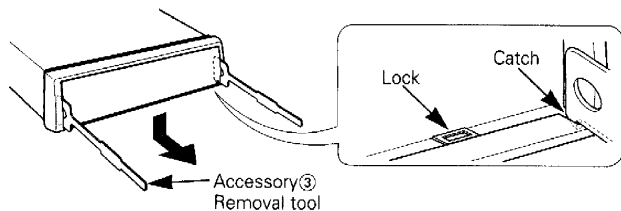

- 2 When the lower level is removed, remove the upper two locations.

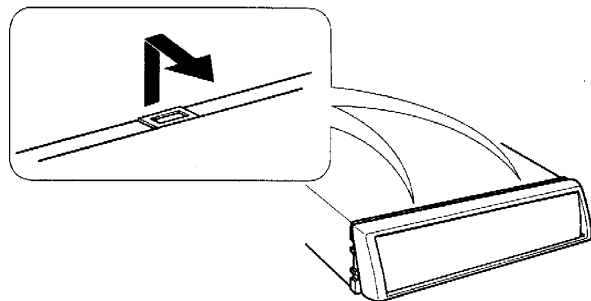

NOTE

The frame can be removed from the top side in the same manner.

■ Removing the Unit

- 1 Refer to the section "Removing the hard rubber frame (P. 25)" and then remove the hard rubber frame.
- 2 Remove the Hex-head screw with integral washer (M4x8) on the back panel.
- 3 Insert the two removal tools deeply into the slots on each side, as shown.

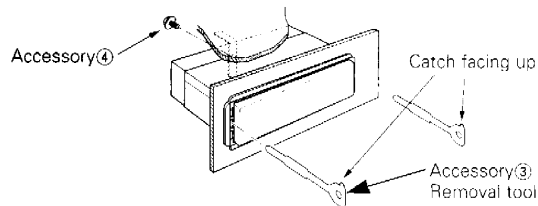

- 4 Lower the removal tool toward the bottom, and pull out the unit halfway whilst pressing towards the inside.

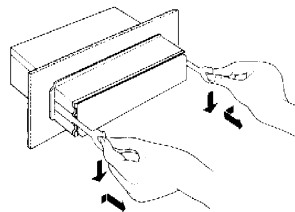

CAUTION

Be careful to avoid injury from the catch pins on the removal tool.

- 5 Pull the unit all the way out with your hands, being careful not to drop it.

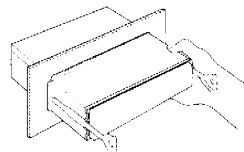

■ Screwing the Faceplate on the Unit

If you want to fasten the faceplate to the main unit so that it does not fall off, screw in the provided screw ($\varnothing 4 \times 16$ mm) in the hole shown below.

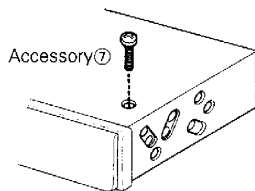

▲CAUTION

Never insert the taptite screw ($\varnothing 4 \times 16$ mm) in any other screw hole than the one specified. If you screw it in another hole, it will contact and may cause damage to the mechanical parts inside the unit.

Troubleshooting Guide

What might seem to be a malfunction in your unit may just be the result of slight misoperation or miswiring. Before calling service, first check the following table for possible problems.

PROBLEM	POSSIBLE CAUSE	SOLUTION
The power does not turn on.	The fuse has blown.	After checking for short circuits in the wires, replace the fuse with one with the same rating.
No sound can be heard, or the volume is low.	Attenuator is turned on.	Turn off Attenuator.
	The fader or balance settings are set all the way to one side.	Reset the fader or balance settings.
	The input/output wires or wiring harness are connected incorrectly.	Reconnect the input/output wires or the wiring harness correctly. See the section on "Connecting Wires to Terminals".
	The value of "V OFFSET" is low.	Increase the value of "V OFFSET".
Nothing happens when the buttons are pressed.	The computer chip in the unit is not functioning normally.	Press the reset button on the unit (see p. 5).
The sound quality is poor or distorted.	One of the speaker wires is being pinched by a screw in the car.	Check the speaker wiring.
	The speakers are not wired correctly.	Reconnect the speaker wires so that each output terminal is connected to a different speaker.
Radio reception is poor.	The car antenna is not extended.	Pull the antenna out all the way.
	The antenna control wire is not connected.	Connect the wire correctly, referring to the section on "Connecting Wires to Terminals".
The memory is erased when the ignition is turned off.	The battery wire has not been connected to the proper terminal.	Connect the wire correctly, referring to the section on "Connecting Wires to Terminals".
	The ignition and battery wire are incorrectly connected.	Connect the wire correctly, referring to the section on "Connecting Wires to Terminals".

MD/External disc control mode

PROBLEM	POSSIBLE CAUSE	SOLUTION
The MD cannot be inserted.	There is already an MD loaded.	Eject the currently loaded MD and then load the new one.
The MD does not load.	The insertion orientation of the MD is incorrect or the MD is upside down.	Insert the MD in the proper orientation.
The MD loads but soon comes out again.	Nothing is recorded on the MD.	Switch the MD for one that is recorded.
The sound skips.	The mounting angle exceeds 30°.	Adjust to an angle of less than 30°.
	The mounting is unstable.	Anchor the unit securely. When the sound skips at the same portion even when the car is stopped, the problem lies with the MD.
There is noise during playback.	The MD is soiled with dust or dirt.	If another MD is played back and there is no problem, then the problem is due to the sound quality of the MD itself.
A track will not play.	Random play has been selected.	Turn off random play.
The disc control mode cannot be selected.	No wire has been connected to the disc changer input terminal on the unit.	Connect the wire to the disc changer input terminal on the unit.
The specified disc does not play, but another one plays instead.	The specified CD is quite dirty.	Clean the CD.
	The CD is upside-down.	Load the CD with the labeled side up.
	The disc is loaded in a different slot from that specified.	Eject the disc magazine and check the number for the specified disc.
	The disc is severely scratched.	Try another disc instead.
The sound skips.	Something is touching the disc changer.	Remove whatever is touching it.
	The CD is scratched or dirty.	If skipping happens at the same place when the car is stopped, something with the CD is wrong. Clean the CD.

PROBLEM	POSSIBLE CAUSE	SOLUTION
The display shows that the changer is being played, but no sound can be heard.	The computer chip in the unit is not functioning normally.	Press the reset button on the unit (see p. 5).
The specified track will not play.	Random play or magazine random play has been selected.	Turn off random play or magazine random play.
Track repeat, disc repeat, track scan, disc scan, random play, and magazine random play start by themselves.	The setting is not cancelled.	The settings for these functions remain on until the setting is turned off or the disc is ejected, even if the power is turned off or the source is changed.

If the following situations, consult your nearest service center:

- Even though the disc changer is connected, the Disc Changer Mode is not on, with "AUX" showing in the display during the Changer Mode.
- Even though no device (KCA-S210A, CA-C1AX, KDC-CPS85, KDC-CX85, KDC-CPS82 or KDC-CX82) is connected, the AUX Mode is entered when switching modes.

The following messages are displayed when certain problems are occurring in your system. Take the recommended actions.

- EJECT No disc magazine has been loaded in the changer. The disc magazine is not completely loaded.
 ⇒ Load the disc magazine properly.
 No CD in the unit.
 ⇒ Insert the CD.

- NO DISC No disc has been loaded in the disc magazine.
 ⇒ Load a disc into the disc magazine.

- E-04 No disc has been loaded in the disc magazine.
 ⇒ Load a disc into the disc magazine.
 The CD is quite dirty. The CD is upside-down. The CD is scratched a lot.
 ⇒ Clean the CD and load it correctly.

- BLANK Nothing has been recorded on the MD.

- NO TRACK No tracks are recorded on the MD, although it has a title.

- NO PANEL The faceplate of the slave unit being connected to this unit has been removed.
 ⇒ Replace it.

- E-77 The unit is malfunctioning for some reason.
 ⇒ Press the reset button on the unit. If the "E- 77" code does not disappear, consult your nearest service center.

- E-99 Something is wrong with the disc magazine, or the unit is malfunctioning for some reason.
 ⇒ Check the disc magazine. And then press the reset button on the unit. If the "E- 99" code does not disappear, consult your nearest service center.

- HOLD The protective circuit in the unit activates when the temperature inside the automatic disc changer exceeds 60°C (140°F), stopping all operation.
 ⇒ Cool down the unit by opening the windows or turning on the air conditioner. As the temperature falls below 60°C (140°F), the disc will start playing again.

-  The MD player section is not operating properly.
 ⇒ Reinsert the MD. If the MD cannot be ejected or the display continues to flash even when the MD has been properly reinserted, please switch off the power and consult your nearest service center.

Specifications

Specifications subject to change without notice.

FM tuner section

Frequency range (200 kHz space)	87.9 MHz – 107.9 MHz
Usable sensitivity (S/N = 30dB)	9.3dBf (0.8 μ V/75 Ω)
Quieting Sensitivity (S/N = 50dB)	15.2dBf (1.6 μ V/75 Ω)
Frequency response (\pm 3.0 dB).....	30 Hz – 15 kHz
Signal to Noise ratio (MONO).....	70 dB
Selectivity (\pm 400 kHz).....	\geq 80 dB
Stereo separation (1 kHz).....	40 dB

AM tuner section

Frequency range (10 kHz space)	530 kHz – 1700 kHz
Usable sensitivity (S/N = 20dB)	28 dB μ (25 μ V)

MD player section

Laser diode	GaAlAs (λ =760 – 800 nm)
Digital filter (D/A)	8 Times Over Sampling
D/A Converter	1 Bit
Frequency response (\pm 2 dB).....	20 Hz – 20 kHz
Total harmonic distortion (1 kHz).....	0.03 %
Signal to Noise ratio	90 dB (1 kHz)
Dynamic range	90 dB
Channel separation.....	85 dB
Spindle speed	400 – 900 rpm
Wow & Flutter.....	Below Measurable Limit

Audio section

Preout Level(mV)/Load	1800 mV/10 k Ω (MD/CD)
Preout Impedance.....	\leq 600 Ω
Maximum output power.....	45 W x 4
Full Bandwidth Power (at less than 1% THD)	22 W x 4
Tone action	
Bass	100Hz \pm 10 dB
Treble	10kHz \pm 10 dB

General

Operating voltage (11 - 16V allowable)	14.4 V
Current Consumption	10 A
Installation Size (W x H x D)	182 x 53 x 160 mm 7-3/16 in x 2-1/16 in x 6-5/16 in
Weight	1.4 kg (3.1 lbs)