



SHARP

MD COMPACT COMPONENT SYSTEM

MODEL

MD-E9000H

OPERATION MANUAL

If you require any advice or assistance regarding your Sharp product, please visit our website www.sharp.co.uk/support. Customers without internet access may telephone 08705 274277 during office hours (or (01) 676 0648 if telephoning from Ireland).



Thank you for purchasing this SHARP product. To obtain the best performance from this product, please read this manual carefully. It will guide you in operating your SHARP product.

MD-E9000H MD Compact Component System consisting of MD-E9000H (main unit) and CP-E9000H (speaker system).

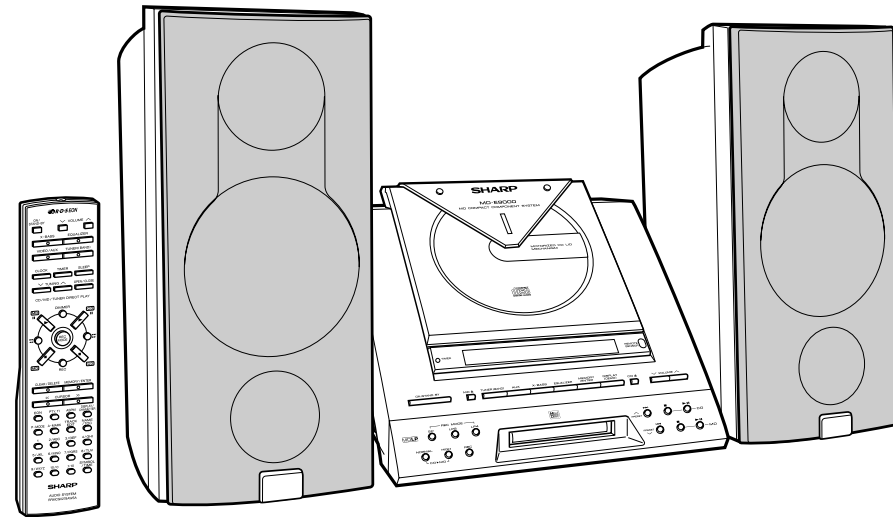

COMPACT
disc
DIGITAL AUDIO

Mini
Disc

MDLP

OR·D·SEON



SAVING ENERGY
STAND-BY POWER
CONSUMPTION **0.6w**





Special Notes

NOTES FOR USERS IN THE U.K. AND IRELAND

The mains lead of this product is fitted with a non-rewireable (moulded) plug incorporating a 3A fuse. Should the fuse need to be replaced, a BSI or ASTA approved BS 1362 fuse marked  or  and of the same rating as above, which is also indicated on the pin face of the plug must be used.

Always refit the fuse cover after replacing the fuse. Never use the plug without the fuse cover fitted.

In the unlikely event of the socket outlet in your home not being compatible with the plug supplied, cut-off the mains plug and fit an appropriate type.

DANGER:

The fuse from the cut-off plug should be removed and the cut-off plug destroyed immediately and disposed of in a safe manner.

Under no circumstances should the cut-off plug be inserted elsewhere into a 13A socket outlet as a serious electric shock may occur.

To fit an appropriate plug to the mains lead, follow the instructions below:

IMPORTANT:

The wires in the mains lead are coloured in accordance with the following code:

- Blue : Neutral
- Brown : Live

As the colours of the wires in the mains lead of this product may not correspond with the coloured markings identifying the terminals in your plug, proceed as follows:

- The wire which is coloured blue must be connected to the plug terminal which is marked N or coloured black.
- The wire which is coloured brown must be connected to the plug terminal which is marked L or coloured red.

Ensure that neither the brown nor the blue wire is connected to the earth terminal in your three pin plug.

Before replacing the plug cover, make sure that:

- If the new fitted plug contains a fuse, its value is the same as that removed from the cut-off plug.
- The cord grip is clamped over the sheath of the mains lead and not simply over the lead wires.

IF YOU HAVE ANY DOUBT, CONSULT A QUALIFIED ELECTRICIAN.

SERVICE INFORMATION

In the unlikely event of your equipment requiring repair, please contact the dealer or supplier from whom it was purchased. Where this is not possible, please visit our web-site www.sharp.co.uk/support.

Customers without internet access may telephone 08705 274277 during office hours (or (01) 676 0648 if telephoning from Ireland).

Please note; all calls will be charged at local rate.

Certain replacement parts and accessories may be obtained from our main parts distributor.

WILLOW VALE ELECTRONICS LTD.
0121 766 5414

In the unlikely event of this equipment requiring repair during the guarantee period, you will need to provide proof of the date of purchase to the repairing company. Please keep your invoice or receipt, which is supplied at the time of purchase.

WARNINGS

- When the ON/STAND-BY button is set at STAND-BY position, mains voltage is still present inside the unit. When the ON/STAND-BY button is set at STAND-BY position, the unit may be brought into operation by the timer mode or remote control.
- This unit contains no user serviceable parts. Never remove covers unless qualified to do so. This unit contains dangerous voltages, always remove mains plug from the socket before any service operation and when not in use for a long period.
- To prevent fire or shock hazard, do not expose this appliance to dripping or splashing. No objects filled with liquids, such as vases, shall be placed on the apparatus.

CAUTION

- Use of controls, adjustments or performance of procedures other than those specified herein may result in hazardous radiation exposure.
- As the laser beam used in this compact disc player is harmful to the eyes, do not attempt to disassemble the cabinet. Refer servicing to qualified personnel only.

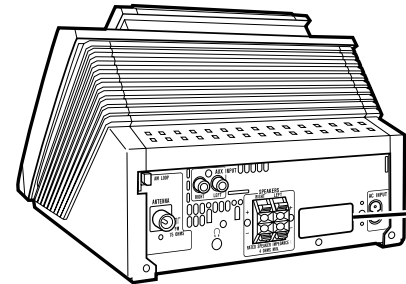

CLASS 1 LASER PRODUCT
APPAREIL À LASER DE CLASSE 1
PRODUCTO LASER DE CLASE 1

NOTES

- Recording and playback of any material may require consent, which SHARP is unable to give. Please refer particularly to the provisions of the Copyright Act 1956, the Dramatic and Musical Performers Protection Act 1958, the Performers Protection Acts 1963 and 1972 and to any subsequent statutory enactments and orders.
- This equipment complies with the requirements of Directives 89/336/EEC and 73/23/EEC as amended by 93/68/EEC.
- US and foreign patents licensed from Dolby Laboratories.



Contents

MD-E9000H

■ Important Instruction	Page	■ Radio	Page
Special Notes	2	Listening to the Radio	22
■ General Information		Listening to a Memorised Station	23
Precautions	4-5	■ RDS Radio	
Accessories	5	Using the Radio Data System (RDS)	24-30
Controls and Indicators	6-9	■ MD Recording	
■ Preparation for Use		Before Recording to a MiniDisc	31
System Connections	10	Recording to a MiniDisc from a CD	32-34
Remote Control	11	Recording to a MiniDisc from the Radio	35
■ Basic Operation		■ MD Editing	
General Control	12	Titling a MiniDisc	36-37
Sound Control	13	Editing a Recorded MiniDisc	38-40
Setting the Clock	14	■ Advanced Features	
■ CD Playback		Timer and Sleep Operation	41-43
Listening to a CD	15-16	Enhancing Your Stereo System	44
■ MD Playback		■ References	
Listening to a MiniDisc	17-18	What is a MiniDisc?	45
■ Advanced CD/MD Playback		MiniDisc System Limitations	45
Programmed Play	19	Error Messages	46
Direct Play	20	Troubleshooting Chart	47-48
Repeat or Random Play	20	Maintenance	48
Switching the Display	21	Specifications	49

TERMS OF GUARANTEE	Back cover
--------------------------	------------

Important Instruction
- Contents -



1



Web-site: www.sharp.co.uk/support Help Line: 08705 274277 (office hours)

3





Precautions

■ General

- Please ensure that the equipment is positioned in a well-ventilated area and that there is at least 10 cm (4") of free space along the sides and back.

There must also be a minimum of 20 cm (8") of free space on the top of the unit.

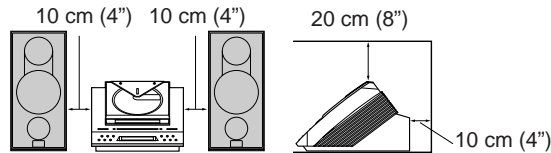

- Use the unit on a firm, level surface free from vibration.

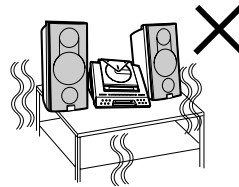

- Keep the unit away from direct sunlight, strong magnetic fields, excessive dust, humidity and electronic/electrical equipment (home computers, facsimiles, etc.) which generates electrical noise.

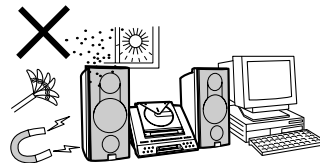

- Do not place anything on top of the unit.
- Do not expose the unit to moisture, to temperatures higher than 60°C (140°F) or to extremely low temperatures.
- If your system does not work properly, unplug it. Plug the AC power lead back in, and then turn on your system.
- In case of an electrical storm, unplug the unit for safety.

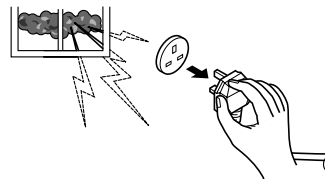

- Hold the AC power plug by the head when unplugging the unit, as pulling the lead can damage internal wires.

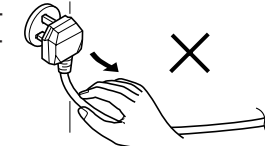

- Do not remove the outer cover, as this may result in electric shock. Refer internal service to your local SHARP service facility.

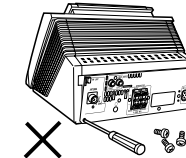

- The ventilation should not be impeded by covering the ventilation openings with items, such as newspapers, tablecloths, curtains, etc.

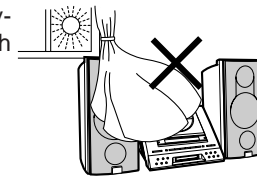

- No naked flame sources, such as lighted candles, should be placed on the apparatus.
- Attention should be drawn to the environmental aspects of battery disposal.
- The apparatus is designed for use in moderate climate.
- This unit should only be used within the range of 5°C - 35°C (41°F - 95°F).

Warnings:

- The voltage used must be the same as that specified on this unit. Using this product with a higher voltage other than that which is specified is dangerous and may result in a fire or other type of accident causing damage. SHARP will not be held responsible for any damage resulting from use of this unit with a voltage other than that which is specified.
- CD players use a laser pickup which can damage the eyes if viewed directly. Do not look at the pickup, and do not touch the pickup directly.

■ Volume control

The sound level at a given volume setting depends on speaker efficiency, location, and various other factors. It is advisable to avoid exposure to high volume levels, which occurs whilst turning the unit on with the volume control setting up high, or whilst continually listening at high volumes.



Accessories

MD-E9000H

Care of compact discs

Compact discs are fairly resistant to damage, however mistracking can occur due to an accumulation of dirt on the disc surface. Follow the guidelines below for maximum enjoyment from your CD collection and player.

- Do not write on either side of the disc, particularly the non-label side from which signals are read. Do not mark this surface.
- Keep your discs away from direct sunlight, heat, and excessive moisture.
- Always hold the CDs by the edges. Fingerprints, dirt, or water on the CDs can cause noise or mistracking. If a CD is dirty or does not play properly, clean it with a soft, dry cloth, wiping straight out from the centre, along the radius.

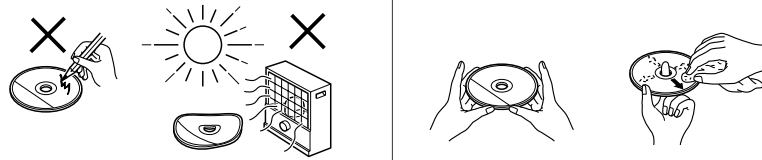

Please confirm that the following accessories are included.

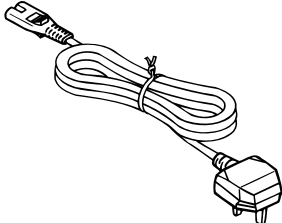
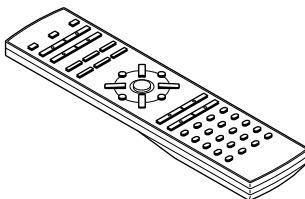
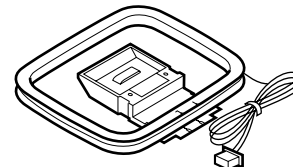
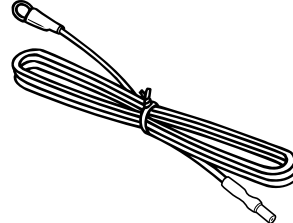
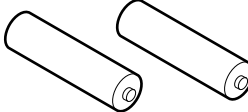
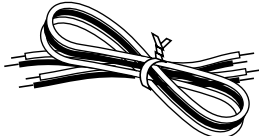
 <p>AC power lead × 1</p>	 <p>Remote control × 1</p>
 <p>AM loop aerial × 1</p>	 <p>FM aerial × 1</p>
 <p>“AAA” size battery (UM-4, R03, HP-16 or similar) × 2</p>	 <p>Speaker wire × 2</p>

Note:
Only the above accessories are included.



2





Controls and Indicators

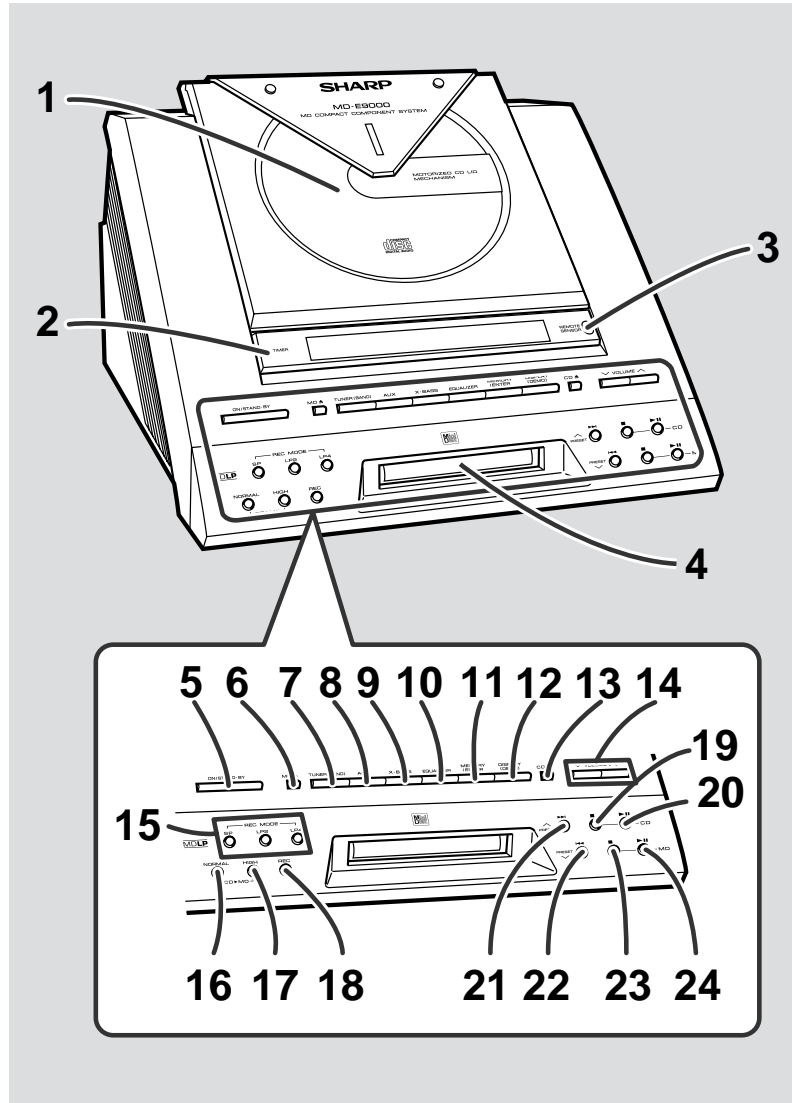

■ Front panel

Reference page

1. CD Compartment	12, 15
2. Timer Set Indicator	41
3. Remote Sensor	11
4. MD Compartment	17
5. On/Stand-by Button	12
6. MD Eject Button	18
7. Tuner (Band) Button	22
8. Auxiliary Button	44
9. Extra Bass Button	13
10. Equalizer Button	13
11. Memory/Enter Button	14, 19, 23
12. Display (Demo) Button	12, 21
13. CD Open/Close Button	12, 15
14. Volume Up and Down Buttons	13
15. MD Record Mode Selector Buttons (SP/LP2/LP4)	32, 35
16. CD/MD Normal Speed Record Button	32
17. CD/MD High Speed Record Button	32
18. MD Record Button	33, 35
19. CD Stop Button	15, 32
20. CD Play or Pause Button	15
21. CD/MD Track Up and Fast Forward, Tuner Preset Up Button	16, 18, 23
22. CD/MD Track Down and Fast Reverse, Tuner Preset Down Button	16, 18, 23
23. MD Stop Button	17, 32, 35
24. MD Play or Pause Button	17, 18

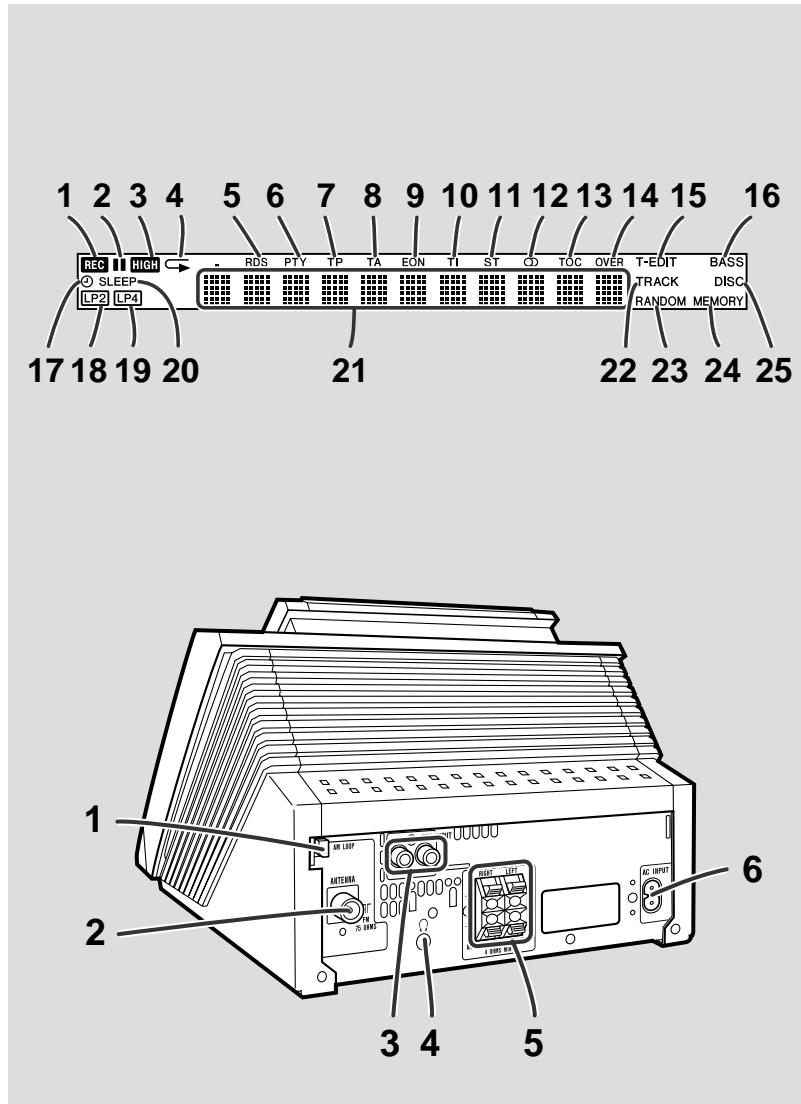

■ Display

1. Record Indicator
2. Record Pause Indicator
3. High Speed Record Indicator
4. CD/MD Repeat Indicator
5. RDS Indicator
6. Programme Type Indicator
7. Traffic Programme Indicator
8. Traffic Announcement Indicator
9. EON Indicator
10. Traffic Information Indicator
11. FM Stereo Mode Indicator
12. FM Stereo Receiving Indicator
13. TOC Indicator
14. Over Indicator
15. Track Edit Indicator
16. Extra Bass Indicator
17. Timer Play/Record Indicator
18. 2 times Long Recording (stereo) Indicator
19. 4 times Long Recording (stereo) Indicator
20. Sleep Indicator
21. Level Meter/Character Information/Frequency Indicator
22. Track Indicator
23. Random Play Indicator
24. Memory Indicator
25. Disc Indicator

■ Rear Panel

	Reference page
1. AM Loop Aerial Socket.....	10
2. FM 75 Ohms Aerial Socket	10
3. Auxiliary (Audio Signal) Input Sockets	44
4. Headphone Socket	44
5. Speaker Terminals	9
6. AC Power Input Socket	10





Controls and Indicators (continued)

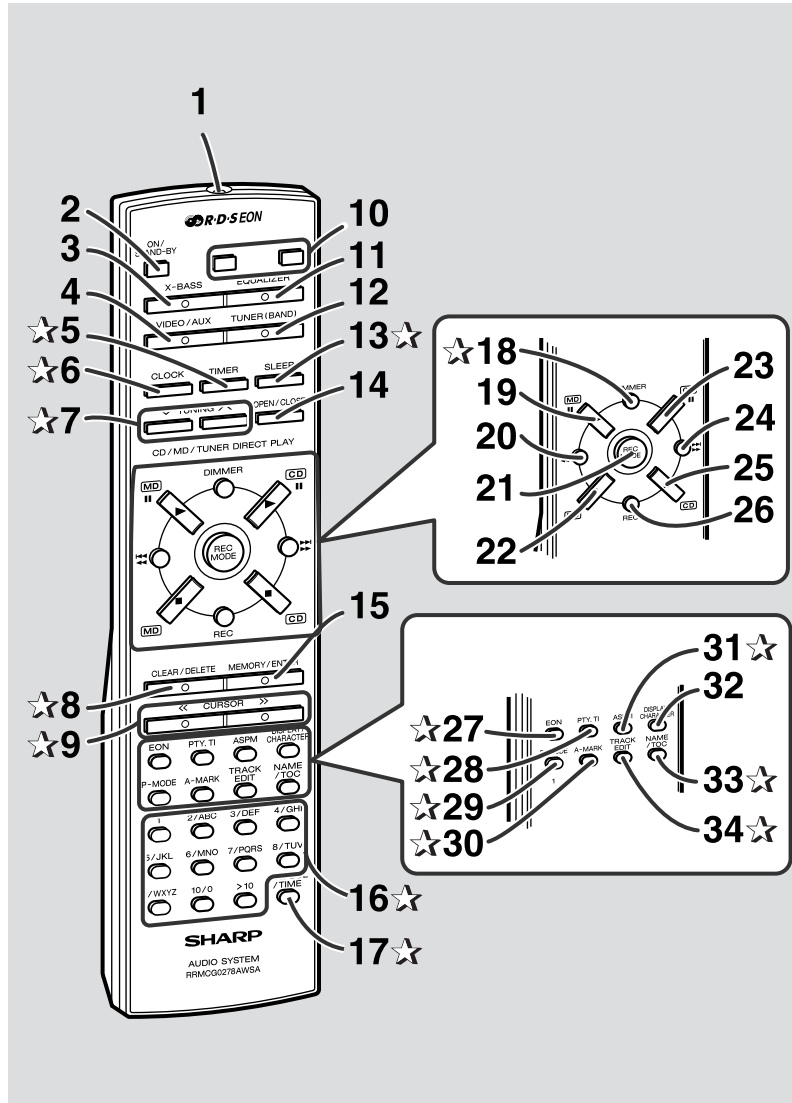

Remote Control

Reference page

1. Remote Control Transmitter	11
2. On/Stand-by Button	
3. Extra Bass Button	
4. Video/Auxiliary Button	
5. Timer Button	41
6. Clock Button	14
7. Tuning Up and Down Buttons	22
8. Clear/Delete Button	19, 23, 37
9. Cursor/MD Recording Level Selector Buttons	37
10. Volume Up and Down Buttons	
11. Equalizer Mode Selector Button	
12. Tuner (Band) Button	
13. Sleep Button	42
14. CD Open/Close Button	
15. Memory/Enter Button	
16. Character Input/CD, MD Direct Buttons	19, 20, 36
17. Symbol/Time Button	21, 36
18. Dimmer Button	12
19. MD Play or Pause Button	
20. CD/MD Fast Reverse, Track Down Button	
21. Recording Mode Selector Button	
22. MD Stop Button	
23. CD Play or Pause Button	
24. CD/MD Fast Forward, Track Up Button	
25. CD Stop Button	
26. MD Record Button	
27. RDS EON Button	28, 29
28. RDS Programme Type/Traffic Information Search Button ...	27-29
29. CD/MD Play Mode Selector Button	20
30. Auto Marker Button	44
31. RDS ASPM (Auto Station Programme Memory) Button	26
32. Display/Character Button	
33. Name/TOC Button	36
34. Track Edit Button	34

Buttons with "★" mark in the illustration can be operated on the remote control only. Other buttons can be operated both on the main unit and the remote control.

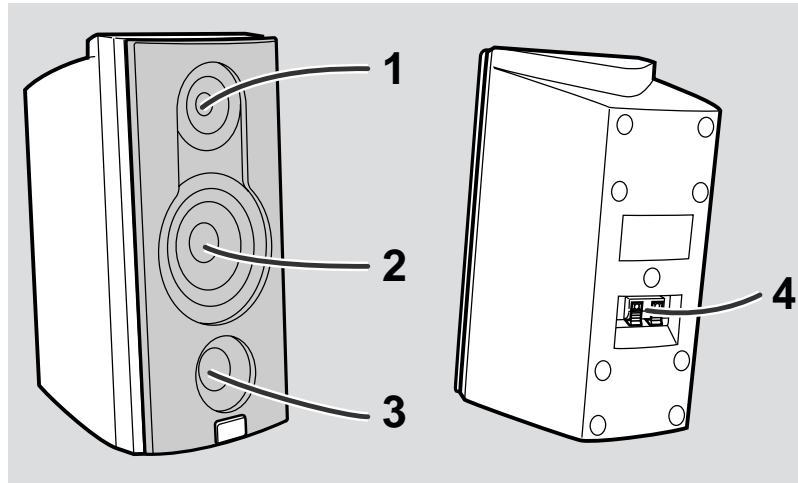

Speaker System

- 1. Tweeter
- 2. Woofer
- 3. Bass Reflex Duct
- 4. Speaker Terminals

Make sure nothing comes into contact with the speaker diaphragms when you remove the speaker grilles.

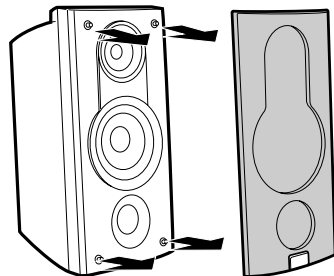

Placing the speaker system:

There is no distinction between the right and the left speakers.

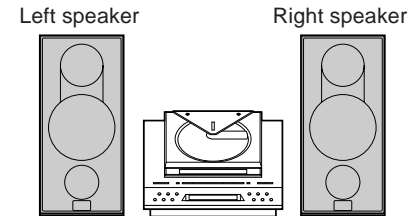

Speaker connection

Connect the black wire to the minus (-) terminal and the red wire to the plus (+) terminal.

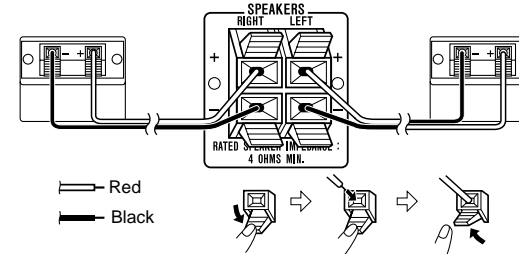

Caution:

- Connect the speaker wires to the speakers first, then to the unit.
- Use speakers with an impedance of 4 ohms or more, as lower impedance speakers can damage the unit.
- Do not mistake the right and the left channels. The right speaker is the one on the right side when you face the unit.
- Do not let the bare speaker wires touch each other.

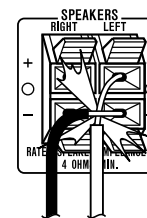

Incorrect

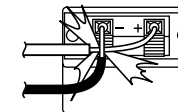

Incorrect

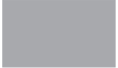



System Connections

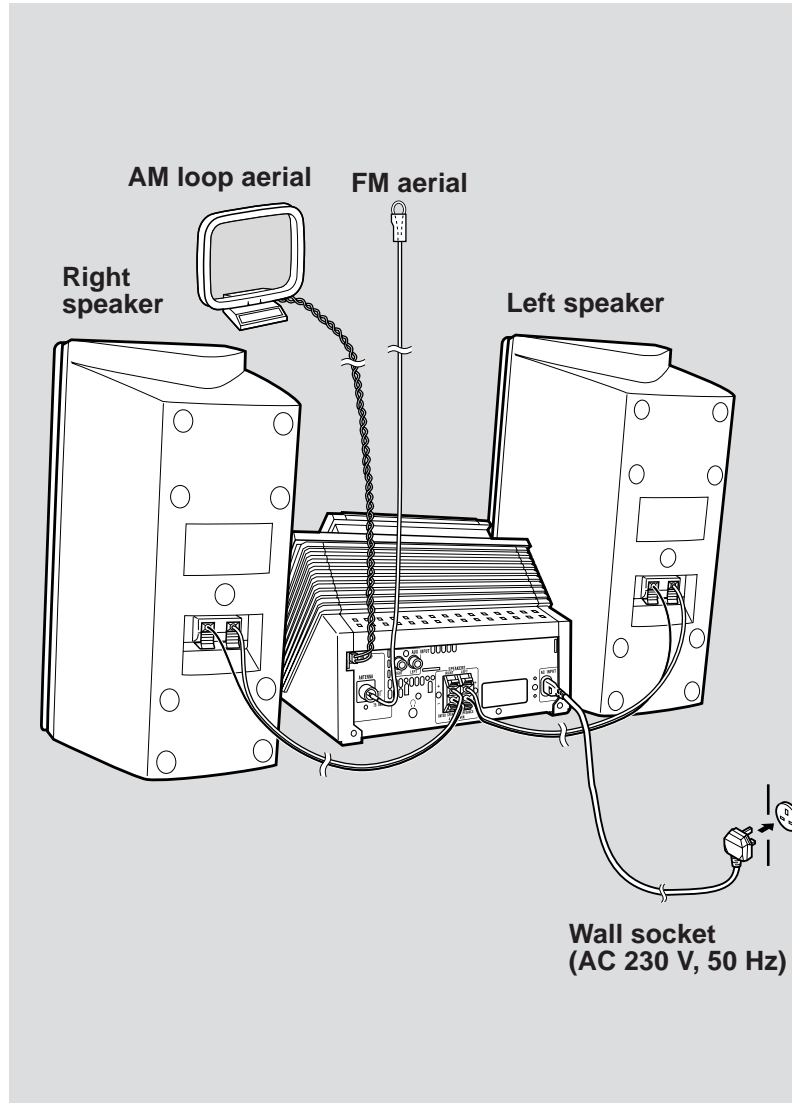

■ Aerial connection

Supplied FM aerial:

Connect the FM aerial wire to the FM 75 OHMS socket and position it in the direction where the strongest signal can be received.

Supplied AM loop aerial:

Connect the AM loop aerial wire to the AM LOOP socket. Position the AM loop aerial for optimum reception. Place the AM loop aerial on a shelf, etc., or attach it to a stand or a wall with screws (not supplied).

Note:

Placing the aerial on the unit or near the AC power lead may cause noise pickup. Place the aerial away from the unit for better reception.

Installing the AM loop aerial:

< Assembling >

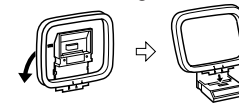

< Attaching to the wall >

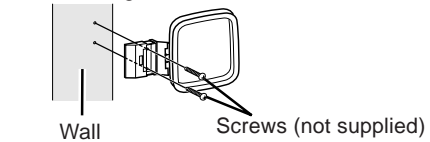

External FM aerial:

Use an external FM aerial if you require better reception. Consult your dealer.

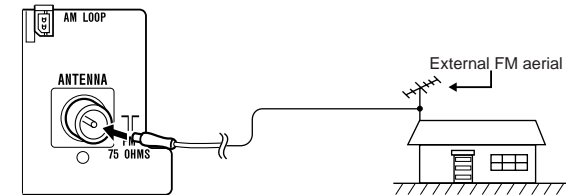

Note:

When an external FM aerial is used, disconnect the supplied FM aerial wire from the FM 75 OHMS socket.

■ Connecting the AC power lead

After checking all the connections have been made correctly, connect the AC power lead to the AC INPUT socket, then into the wall socket.

Notes:

- Unplug the unit if it will not be used for a prolonged period of time.
- Use only the supplied power lead. Otherwise, a malfunction or an accident may occur.



Remote Control

MD-E9000H

■ Battery installation

1. Remove the battery cover.
2. Insert the batteries according to the direction indicated in the battery compartment.
When inserting or removing the batteries, push them towards the ⊖ terminals.
3. Replace the cover.

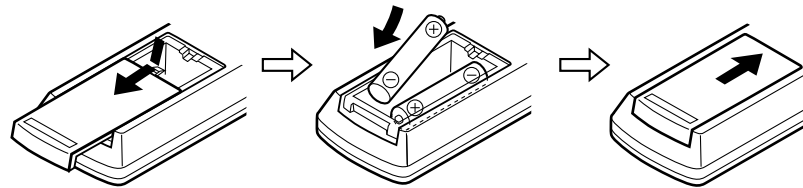

Precautions for battery use:

- Replace all old batteries with new ones at the same time.
- Do not mix old and new batteries.
- Remove the batteries if the unit will not be used for long periods of time. This will prevent potential damage due to battery leakage.

Caution:

- Do not use rechargeable batteries (nickel-cadmium battery, etc.).
- Installing the batteries incorrectly may cause the unit to malfunction.

Notes concerning use:

- Replace the batteries if the operating distance is reduced or if the operation becomes erratic. Purchase 2 "AAA" size batteries (UM-4, R03, HP-16 or similar).
- Periodically clean the transmitter on the remote control and the sensor on the unit with a soft cloth.
- Exposing the sensor on the unit to strong light may interfere with operation. Change the lighting or the direction of the unit.
- Keep the remote control away from moisture, heat, shock, and vibrations.

■ Test of the remote control

Face the remote control directly to the remote sensor on the unit.

The remote control can be used within the range shown below:
Press the ON/STAND-BY button. Does the power turn on? Now, you can enjoy the music.

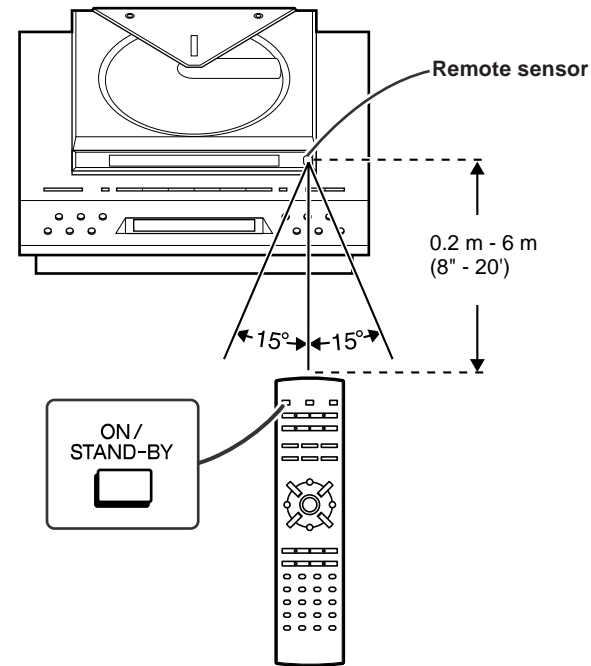

Preparation for Use
- Remote Control -

3

Web-site: www.sharp.co.uk/support Help Line: 08705 274277 (office hours)

11



General Control

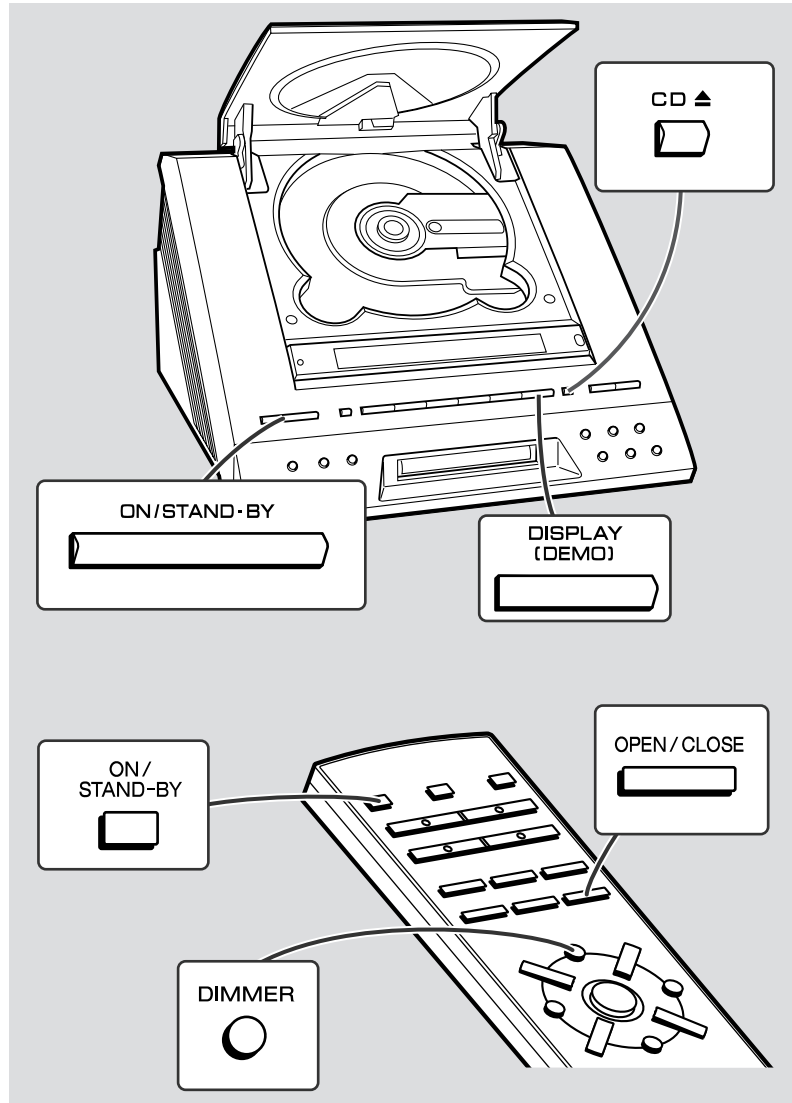

■ Demonstration mode

The first time the unit is plugged in, the unit will enter the demonstration mode. You will see words scroll.

<< DEMO >>

To cancel the demonstration mode:

When the unit is in the power stand-by mode (demonstration mode), press the DISPLAY (DEMO) button. The unit will enter the low power consumption mode.

To return to the demonstration mode:

When the unit is in the power stand-by mode, press the DISPLAY (DEMO) button again.

■ To turn the power on

Press the ON/STAND-BY button.

HELLO!

To set the unit to stand-by mode:

Press the ON/STAND-BY button again.

■ To change the display brightness (2 levels)

You can switch the display brightness by pressing the DIMMER button on the remote control.

FM108.00MHz
Dimmed
↔
FM108.00MHz
Brightened

■ Opening and closing the CD compartment

The CD compartment cover is motorised.

When the power is turned on, you can open or close the CD compartment by pressing the CD ▲ (OPEN/CLOSE) button.

Caution:

- Do not open or close the CD compartment cover manually. It may cause malfunctions to the unit.
- Be careful not to jam your fingers in the CD compartment cover.



Sound Control

MD-E9000H

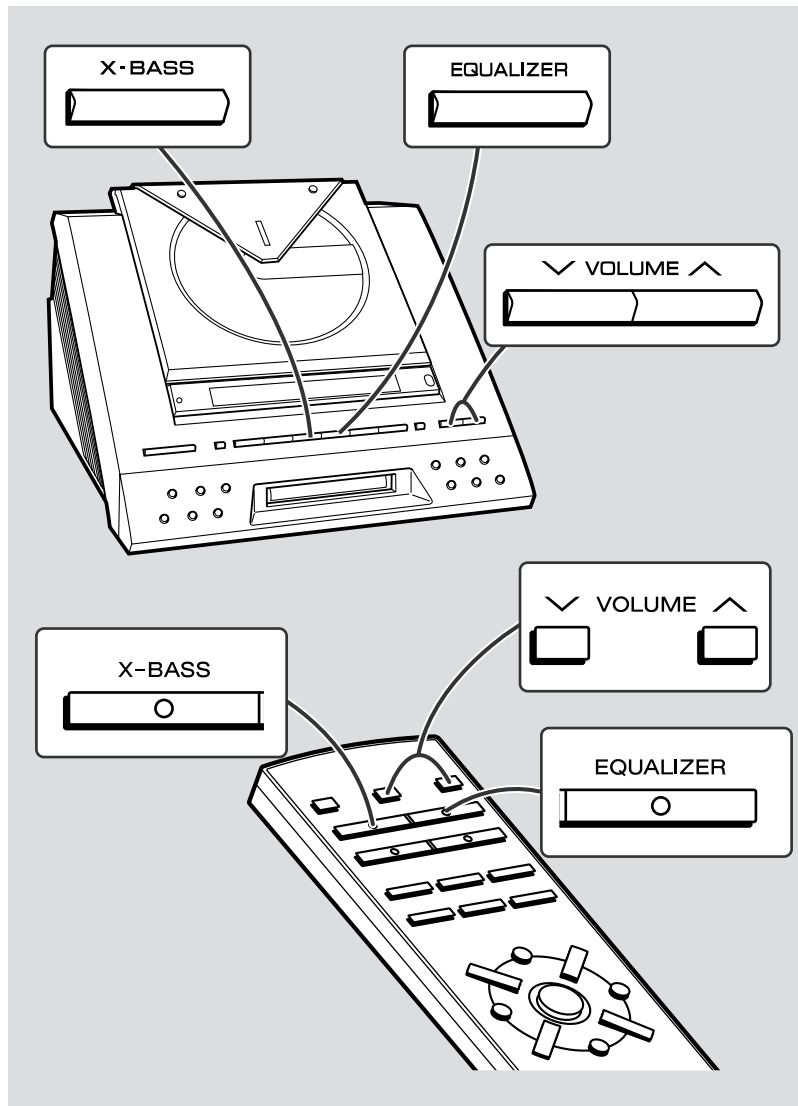

■ Adjusting the volume

Press the VOLUME \wedge button to increase the volume and the VOLUME \vee button for decreasing.



■ Bass control

When the power is first turned on, the unit will enter the extra bass mode which emphasises the bass frequencies, and "BASS" will appear. To cancel the extra bass mode, press the X-BASS button.

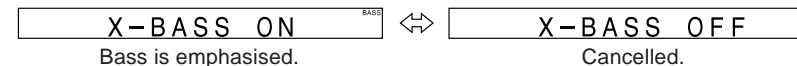

The "X-BASS" function is only accessible with the equaliser set to "FLAT".

■ Equaliser

When the EQUALIZER button is pressed, the current mode setting will be displayed. To change to a different mode, press the EQUALIZER button repeatedly until the desired sound mode appears.

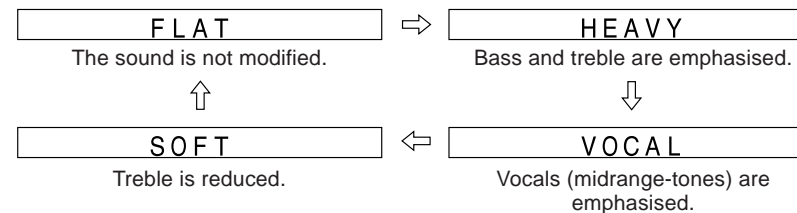

4



Setting the Clock

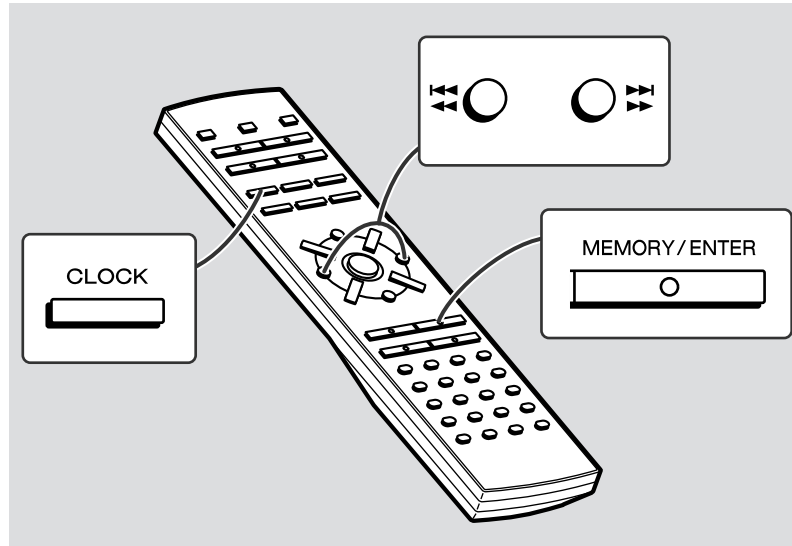

This may be operated only with the remote control.
 In this example, the clock is set for the 24-hour (0:00) display.

- 1** Press the **CLOCK** button and within 10 seconds, press the **MEMORY/ENTER** button.

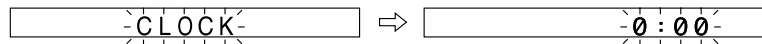

- 2** Press the **◀◀/▶▶** button to select 24-hour or 12-hour display and then press the **MEMORY/ENTER** button.

- "0:00" → The 24-hour display will appear.
(0:00 - 23:59)
- "AM 0:00" → The 12-hour display will appear.
(AM 0:00 - PM 11:59)
- "AM 12:00" → The 12-hour display will appear.
(AM 12:00 - PM 11:59)

- 3** Press the **◀◀/▶▶** button to adjust the hour and then press the **MEMORY/ENTER** button.

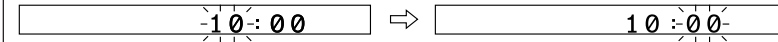

- When the 12-hour display is selected, "AM" will change automatically to "PM".

- 4** Press the **◀◀/▶▶** button to adjust the minutes and then press the **MEMORY/ENTER** button.

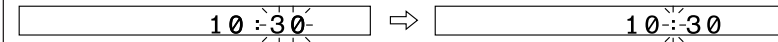

- The hour will not advance even if minutes advance from "59" to "00".
- The clock starts from "0" second. (Seconds are not displayed.)

To check the time when the power is on:

Press the **CLOCK** button.
 The time display will appear for about 10 seconds.

Note:

The "0:00" or time will flash at the push of the **CLOCK** button when the AC power supply is restored after a power failure or unplugging the unit.
 Readjust the clock by performing "Setting the Clock" from the beginning.



Listening to a CD

MD-E9000H

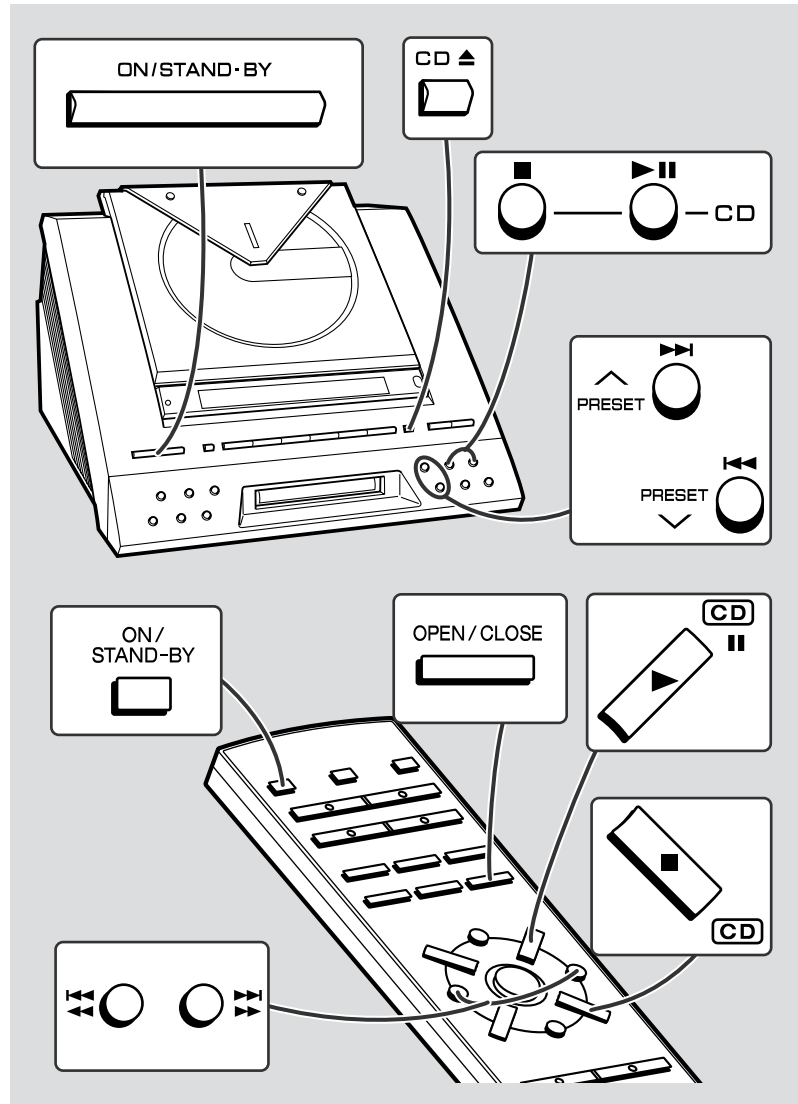

- 1 Press the ON/STAND-BY button to turn the power on.
- 2 Press the CD button.
 - If no disc is loaded, "CD NO DISC" will appear.
- 3 Press the CD (OPEN/CLOSE) button to open the CD compartment.
- 4 Place a CD on the spindle, label side up.

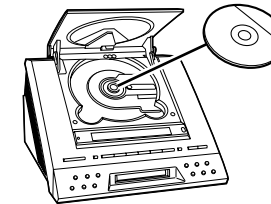

- 5 Press the CD (OPEN/CLOSE) button to close the CD compartment.

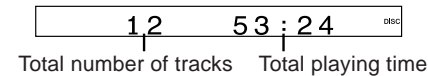

- 6 Press the CD (PLAY/PAUSE) button to start playback from track 1.

When the last track on the disc has finished, the CD player will stop automatically.

To interrupt playback:

Press the CD (PLAY/PAUSE) button.
To resume playback from the same point, press the CD (PLAY/PAUSE) button again.

To stop playback:

Press the CD (STOP) button.

CD Playback
- Listening to a CD -

5

Web-site: www.sharp.co.uk/support Help Line: 08705 274277 (office hours)



Listening to a CD (continued)

To remove the CD:

Whilst in the stop mode, press the CD ▲ (OPEN/CLOSE) button. Press the CD eject button and remove the CD.

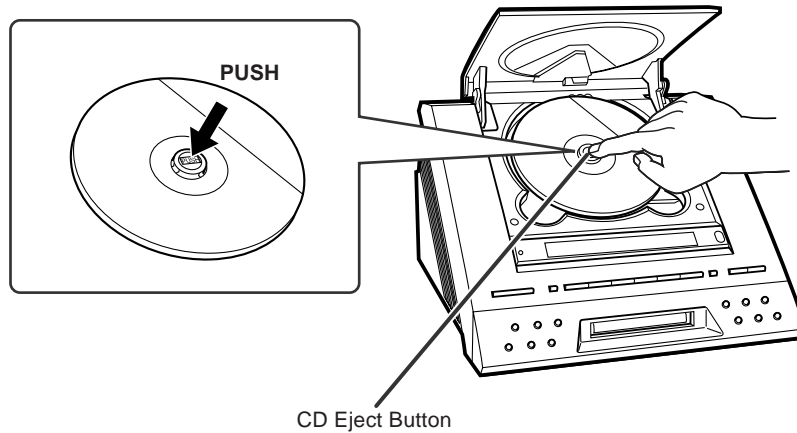

Notes:

- After removing the CD, make sure to press the CD ▲ (OPEN/CLOSE) button and close the CD compartment.
- When the unit enters the stand-by mode, the opened CD compartment cover will be closed automatically.

After use:

Press the ON/STAND-BY button to enter the power stand-by mode.

Caution:

- Do not open or close the CD compartment cover manually. It may cause malfunctions to the unit.
- Be careful not to jam your fingers in the CD compartment cover.
- If the power fails whilst the compartment is open, wait until the power is restored.
- If a disc is damaged, dirty, or loaded upside down, "CD NO DISC" will appear on the display.
- Keep foreign objects out of the CD compartment.
- Subjecting the unit to shock or vibration may cause mistracking.
- When the unit is not being used, be sure to close the CD compartment. If it is left open, the lens may be covered with dust and the unit may not operate properly.
- If TV or radio interference occurs during CD operation, move the unit away from the TV or radio.

■ To locate the beginning of a track

To move to the beginning of the next track:

Press the ►► button for less than 0.5 seconds during playback.

- You can skip to any track by pressing the ►► button repeatedly until the desired track number appears.

To restart the track being played:

Press the ◀◀ button for less than 0.5 seconds during playback.

- You can skip to any track by pressing the ◀◀ button repeatedly until the desired track number appears.

■ To locate the desired portion

For audible fast forward:

Press and hold down the ►► button during playback.

For audible fast reverse:

Press and hold down the ◀◀ button during playback.

Notes:

- Normal playback will resume when the ◀◀ or ►► button is released.
- When the end of the last track is reached during fast forward, "END" will appear on the display and CD operation will be paused. When the beginning of the first track is reached during fast reverse, playback will start automatically.
- The ◀◀/◀◀ or ►►/►► button on the remote control allows you the same operations.



Listening to a MiniDisc

MD-E9000H

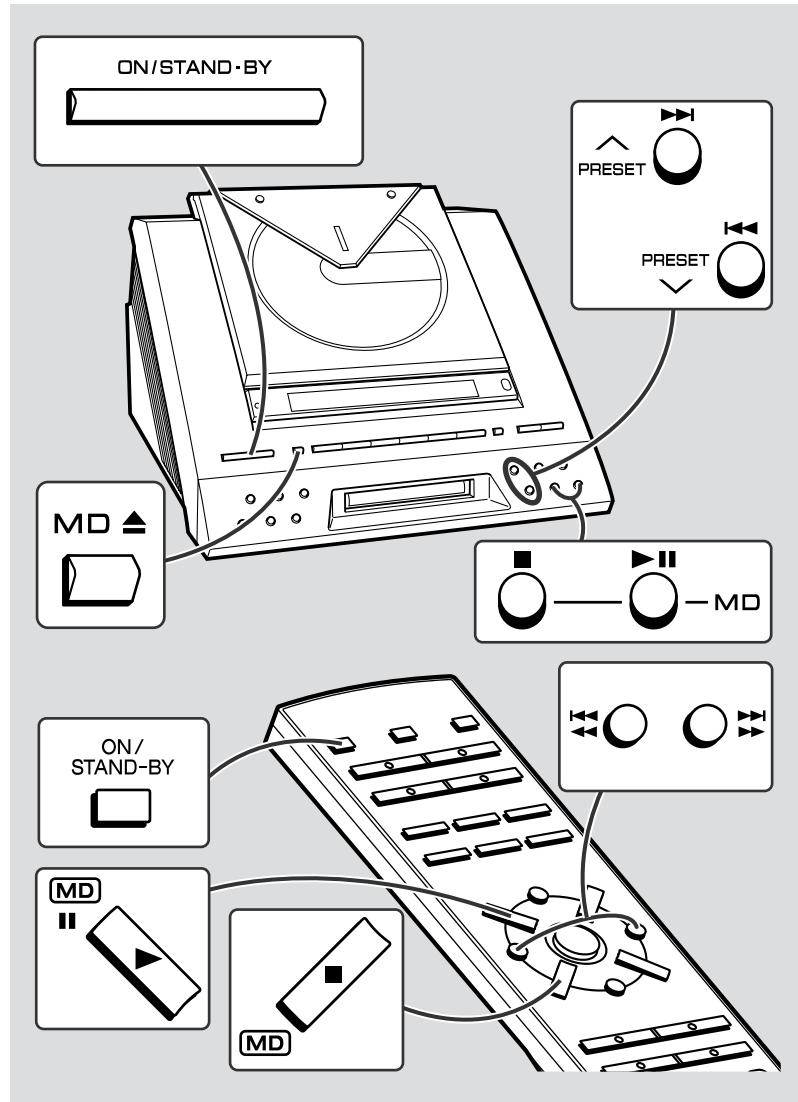

1 Press the ON/STAND-BY button to turn the power on.

2 Press the MD ■ button.

3 Load a MiniDisc into the MD compartment, label side up.

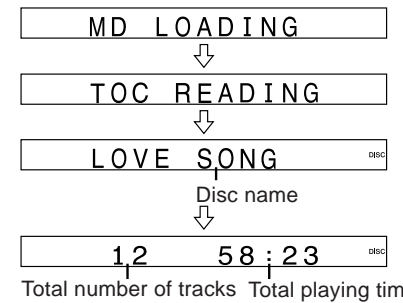
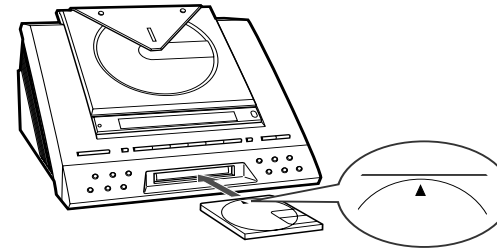

- The disc name will be displayed only when it has been programmed, and then the total number of tracks and the total playing time on the MiniDisc will be displayed.

4 Press the MD ►|| button to start playback.

- If the MiniDisc has track names, they will appear and scroll across the display. Then, the elapsed playing time will appear.
- If the MiniDisc has no track names, the elapsed playing time will appear.
- When the last track has finished, the MD player will stop automatically.
- Each time the DISPLAY (DEMO) button is pressed during playback or when in the pause mode, the display will change (see page 21).

MD Playback
- Listening to a MiniDisc -



6



Web-site: www.sharp.co.uk/support Help Line: 08705 274277 (office hours)





Listening to a MiniDisc (continued)

To interrupt playback:

Press the MD ►|| button.

To resume playback from the same point, press the MD ►|| button again.

To stop playback:

Press the MD ■ button.

To remove a MiniDisc:

Whilst in the stop mode, press the MD ▲ button.

After use:

Press the ON/STAND-BY button to enter the power stand-by mode.

Caution:

- If TV or radio interference occurs during MiniDisc operation, move the unit away from the TV or radio.
- Although MiniDiscs will not normally skip due to vibration, you may hear skipping in the sound if there is continuous vibration. If the volume is turned up too high, sound skipping may occur depending on the contents of the MiniDisc. If this happens, turn the volume down and the skipping should stop.
- If an error message is displayed during MiniDisc operation, see "Error Messages" on page 45.

■ To locate the beginning of a track

To move to the beginning of the next track:

Press the ►| button for less than 0.5 seconds during playback.

- You can skip to any track by pressing the ►| button repeatedly until the desired track number appears.

To restart the track being played:

Press the ◀◀ button for less than 0.5 seconds during playback.

- You can skip to any track by pressing the ◀◀ button repeatedly until the desired track number appears.

■ To locate the desired portion

For audible fast forward:

Press and hold down the ►| button during playback.

For audible fast reverse:

Press and hold down the ◀◀ button during playback.

Notes:

- Normal playback will resume when the ◀◀ or ►| button is released.
- When the end of the last track is reached during fast forward, "END" will appear in the display and MiniDisc operation will be paused. When the beginning of the first track is reached during fast reverse or the ◀◀ button is released, the unit will enter the playback mode.
- The ◀◀/◀◀ or ►|/►| button on the remote control allows you the same operations.



Programmed Play

MD-E9000H

You can choose up to 20 out of 99 tracks for playback in the order you like.

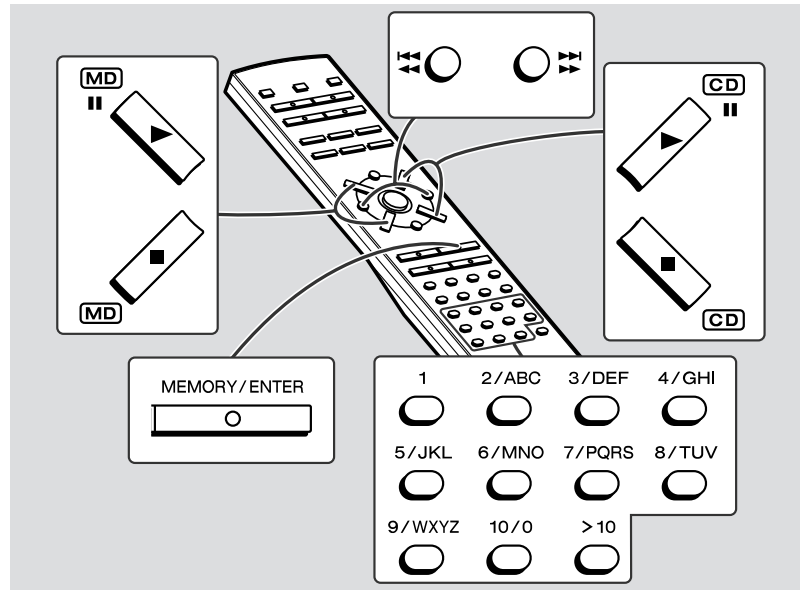

1 Press the CD ■ or MD ■ button.

2 Press the MEMORY/ENTER button to enter the programming save mode.

PROGRAM MEMORY

3 Use the direct buttons to select the desired track.

7 P 1 5 : 27

Selected track number Playback order Playback time

4 Repeat step 3 for any other tracks. Up to 20 tracks (P20) can be programmed.

5 Press the CD ■ or MD ■ button.

6 23 : 42 DISC MEMORY

Total number of tracks Total playback time

6 Press the CD ►|| or MD ►|| button to start playback of the programmed selections.

- After all of the programmed tracks have finished, the unit will automatically stop.

To clear the programmed selections:

Press the CLEAR/DELETE button on the remote control whilst the "MEMORY" indicator is flashing.

- Each time the button is pressed, one track will be cleared, beginning with the last track programmed.

To cancel the programmed play mode:

Whilst in the stop mode, press the CLEAR/DELETE button to turn off the "MEMORY" display.

- The programme contents will be erased.
- When you open the CD compartment cover or eject a MiniDisc, the programmed play mode will be cancelled.

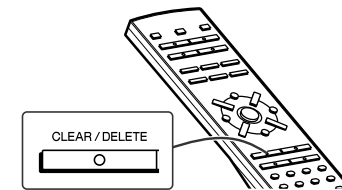

To check which tracks are programmed:

Whilst the unit is in the stop mode, press the ◀◀/▶▶ or ▶▶/▶▶ button.

Adding tracks to the programme:

If a programme has been previously stored, the "MEMORY" indicator will be displayed. Then follow steps 2 - 5 to add tracks. The new tracks will be stored after the last track of the original programme.

Notes:

- It is not possible to insert a track between programmed tracks.
- Programming and cancelling are not possible during playback or in the pause mode.



Direct Play



When in the CD or MD mode, press the direct buttons to select the desired track.

To select a track between the 11th and 99th tracks:

Select the track after pressing the >10 button.

A. For example, to choose 28

- 1 Press the ">10" button.
- 2 Press the "2" button.
- 3 Press the "8" button.

To select a track beyond the 100th track (MD only):

Select the track after pressing the >10 button twice.

B. For example, to choose 105

- 1 Press the ">10" button twice.
- 2 Press the "1" button.
- 3 Press the "10/0" button.
- 4 Press the "5" button.

Repeat or Random Play

You can select the CD or MD playback mode; "Repeat play", "Random play" and "Normal play".

- 1 When in the CD or MD mode, press the P-MODE button on the remote control repeatedly to select the playback mode.

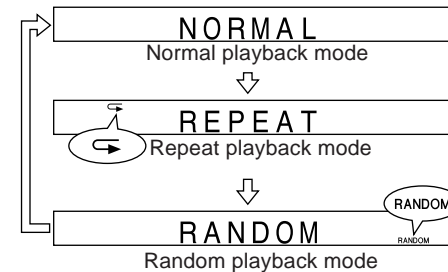

- 2 Press the CD ►|| or MD ►|| button to start playback.

To repeat a programmed sequence:

Perform steps 1 - 5 in the "Programmed Play" section and then select the repeat playback.

Notes:

- During programme operation, random play is not possible.
- After using repeat play, be sure to press the CD ■ or MD ■ button. Otherwise, the disc will play continuously.
- The random play will stop automatically when all tracks are played once. (The same track will not be played back twice.)
- In random play, the CD or MiniDisc player will select and play tracks automatically. (You cannot select the order of the tracks.)

To cancel repeat or random play:

Press the P-MODE button repeatedly to select the normal playback mode.



Switching the Display

MD-E9000H

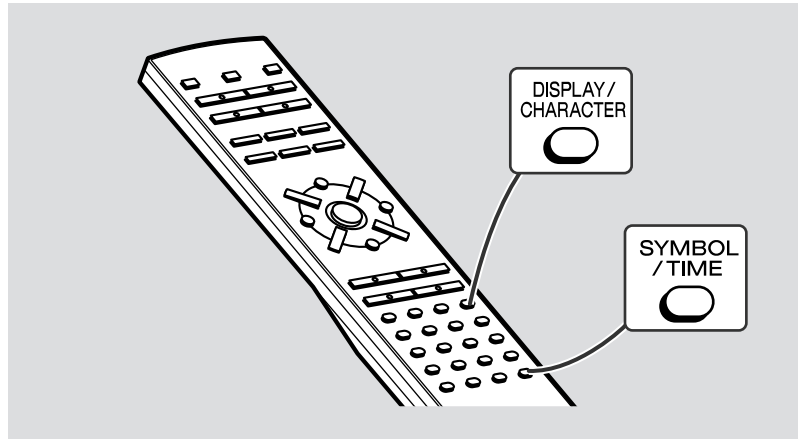

Switching the display during MD playback

Each time the DISPLAY (DEMO) button on the main unit or the DISPLAY/CHARACTER button on the remote control is pressed during MD playback, the display will change.

The elapsed playing time for the current track will be displayed.

1 0 : 03 TRACK

The track name will be displayed.

1 : LOVE SO TRACK

"NO NAME" is displayed if the track is not named.

The level meter is displayed.

L R [Level Meter] OVER

Tracks recorded in monaural is indicated as "M".

Remaining recording time is displayed.

SP - 022 : 20

Notes:

- When the level meter is displayed, it remains unchanged during playback.
- It returns to normal when the disc is removed.
- The remaining recording time is not displayed for playback-only MD.

Switching the time display

Each time the SYMBOL/TIME button on the remote control is pressed during playback, the display will change.

The elapsed playing time for the current track will be displayed.

1 0 : 03 TRACK

The remaining playing time for the current track will be displayed.

1 - 3 : 12 TRACK

The total remaining playing time for the disc will be displayed.

1 - 27 : 29

Notes:

- During random play, the total remaining playing time will not be displayed.
- Depending on the CD or MiniDisc, the playing time display may not match the total playing time which is indicated on the CD or MiniDisc jacket, as the time between tracks is not included.





Listening to the Radio

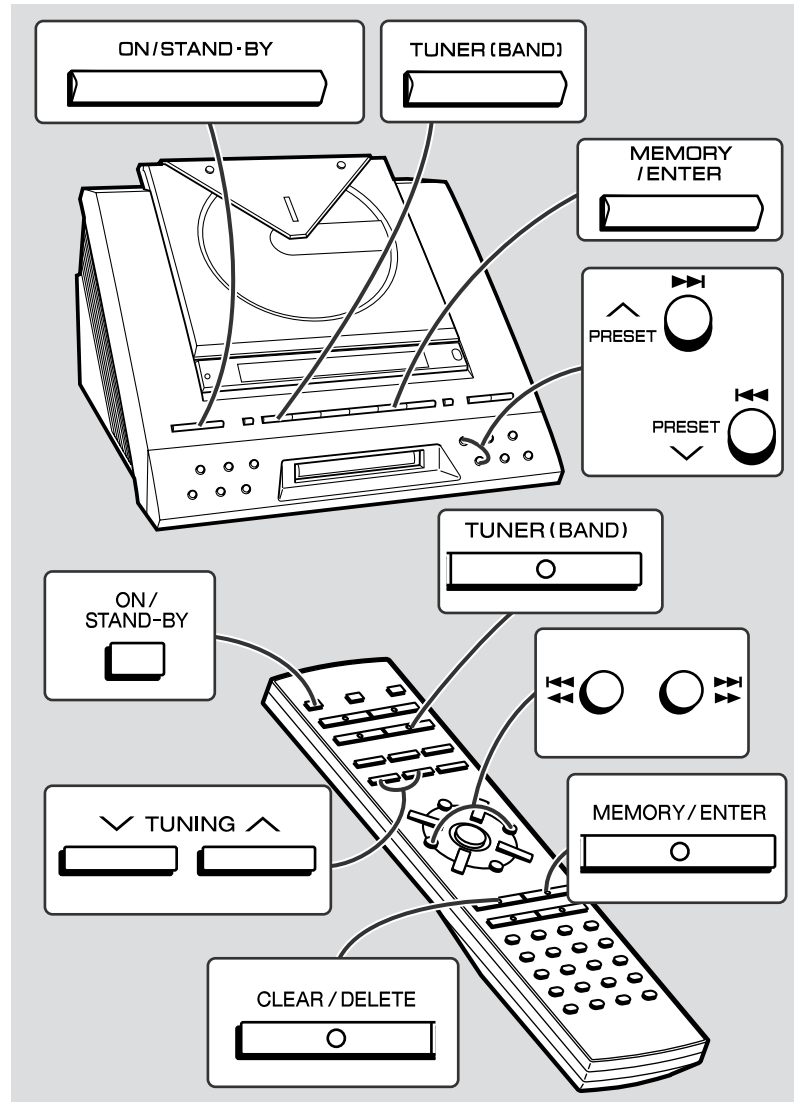

- 1** Press the ON/STAND-BY button to turn the power on.
- 2** Press the TUNER (BAND) button until "FM" or "AM" appears on the display.
- 3** Press the TUNING (V or ^) button on the remote control to tune in to the desired station.

Manual tuning:

Press the TUNING button as many times as required to tune in to the desired station.

Auto tuning:

When the TUNING button is pressed for more than 0.5 seconds, scanning will start automatically and the tuner will stop at the first receivable broadcast station.

Notes:

- This can be operated by using the remote control only.
- When radio interference occurs, auto scan tuning may stop automatically at that point.
- Auto scan tuning will skip weak signal stations.
- To stop the auto tuning, press the TUNING button on the remote control again.
- When an RDS (Radio Data System) station is tuned in, the frequency will be displayed first, and then the RDS indicator will light. Finally, the station name will appear.
- Full auto tuning can be achieved for RDS stations (see "ASPM" on page 26).

To receive an FM stereo transmission:

Press the TUNER (BAND) button to display "ST".

- "∞" will appear when an FM broadcast is in stereo.

FM stereo mode indicator ST FM stereo receiving indicator

ST FM 87.50MHz

- If the FM reception is weak, press the TUNER (BAND) button to extinguish "ST". The reception changes to monaural, and the sound becomes clearer.

After use:

Press the ON/STAND-BY button to enter the power stand-by mode.



Listening to a Memorised Station

MD-E9000H

■ Memorising a station

You can store 40 AM and FM stations in memory and recall them at the push of a button. (Preset tuning)

1 Perform the steps 1 - 3 in "Listening to the Radio" on page 22.

2 Press the MEMORY/ENTER button to enter the preset tuning saving mode.

3 Within 5 seconds, press the PRESET (∨ or ∧) button to select the preset channel number.



Store the stations in memory, in order, starting with preset channel 1.

4 Within 5 seconds, press the MEMORY/ENTER button to store that station in memory.

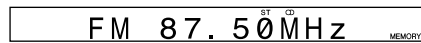

If the "MEMORY" and preset number indicators go out before the station is memorised, repeat the operation from step 2.

5 Repeat steps 1 - 4 to set other stations, or to change a preset station.

When a new station is stored in memory, the station previously memorised will be erased.

Note:

The backup function protects the memorised stations for a few hours should there be a power failure or the AC power lead disconnection.

■ To recall a memorised station

When in the tuner mode, press the PRESET (∨ or ∧) button to select the desired station.

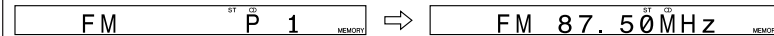

■ To clear all memorised stations

- 1 Press the CLEAR/DELETE button on the remote control for 3 seconds or more.
- 2 Within 10 seconds, press the MEMORY/ENTER button.



Using the Radio Data System (RDS)

RDS is a broadcasting service which a growing number of FM stations provide. These FM stations send additional signals along with their regular programme signals. They send their station names, and information about the type of programme such as sports or music, etc.

When tuned to an RDS station, "RDS" and the station name will be displayed. "TP" (Traffic Programme) will appear on the display when the received broadcast carries traffic information, and "TA" (Traffic Announcement) will appear whilst a traffic information is on air (see page 30). "EON" will appear whilst the EON (Enhanced Other Networks information) data is broadcast.

You can control the RDS by using the remote control only.

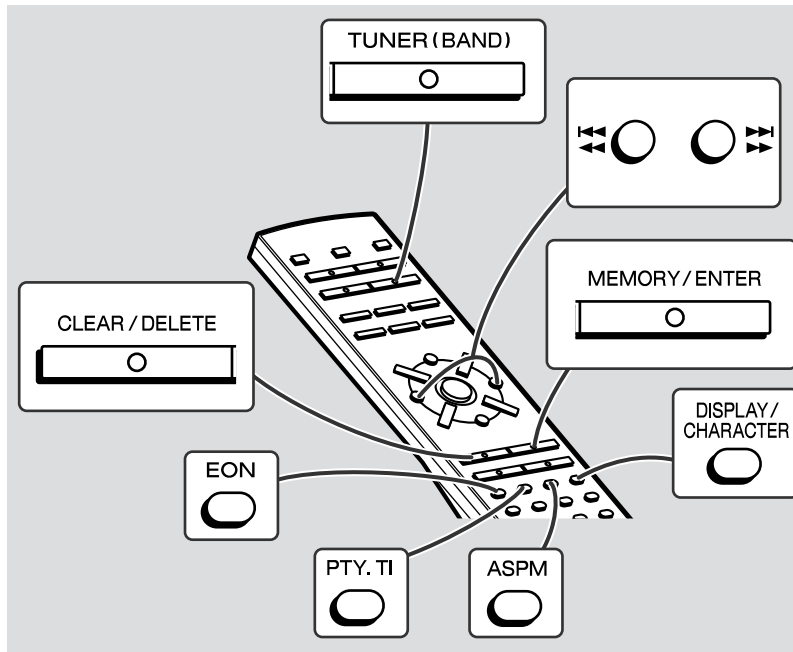

Information provided by RDS

Each time the DISPLAY/CHARACTER button is pressed, the display will switch as follows:

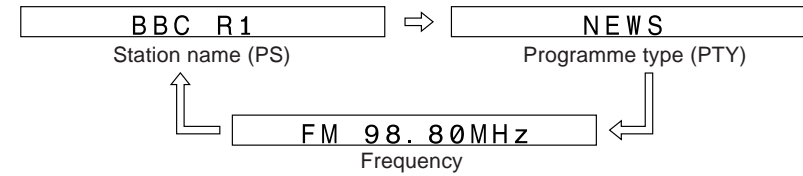

When you are tuning in to a station other than an RDS station or to an RDS station which sends weak signal, the display will change in the following order:

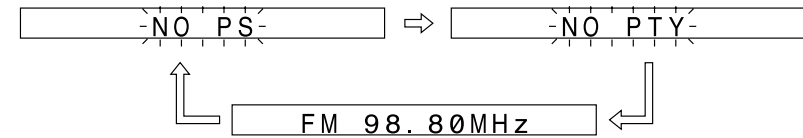

**Descriptions of the PTY (Programme Type) codes, TP (Traffic Programme) and TA (Traffic Announcement)**

You can search for and receive the following PTY, TP and TA signals.

NEWS	Short accounts of facts, events and publicly expressed views, reportage and actuality.
AFFAIRS	Topical programme expanding or enlarging upon the news, generally in different presentation style or concept, including debate, or analysis.
INFO	Programmes whose purpose is to impart advice in the widest sense.
SPORT	Programme concerned with any aspect of sport.
EDUCATE	Programme intended primarily to educate, of which the formal element is fundamental.
DRAMA	All radio plays and serials.
CULTURE	Programmes concerned with any aspect of national or regional culture, including language, theatre, etc.
SCIENCE	Programmes about the natural sciences and technology.
VARIED	Used for mainly speech-based programmes usually of light-entertainment nature, not covered by other categories. Examples include: quizzes, panel games, personality interviews.
POP M	Commercial music, which would generally be considered to be of current popular appeal, often featuring in current or recent record sales charts.
ROCK M	Contemporary modern music, usually written and performed by young musicians.
EASY M	Current contemporary music considered to be "easy-listening", as opposed to Pop, Rock or Classical, or one of the specialised music styles, Jazz, Folk or Country. Music in this category is often but not always vocal, and usually of short duration.
LIGHT M	Classical music for general, rather than specialist appreciation. Examples of music in this category are instrumental music, and vocal or choral works.
CLASSICS	Performances of major orchestral works, symphonies, chamber music, etc., and including Grand Opera.
OTHER M	Musical styles not fitting into any of the other categories. Particularly used for specialist music of which Rhythm & Blues and Reggae are examples.
WEATHER	Weather reports and forecasts and meteorological information.
FINANCE	Stock Market reports, commerce, trading, etc.
CHILDREN	For programmes targeted at a young audience, primarily for entertainment and interest, rather than where the objective is to educate.

SOCIAL	Programmes about people and things that influence them individually or in groups. Includes: sociology, history, geography, psychology and society.
RELIGION	Any aspect of beliefs and faiths, involving a God or Gods, the nature of existence and ethics.
PHONE IN	Involving members of the public expressing their views either by phone or at a public forum.
TRAVEL	Features and programmes concerned with travel to near and far destinations, package tours and travel ideas and opportunities. Not for use for announcements about problems, delays, or roadworks affecting immediate travel where TP/TA should be used.
LEISURE	Programmes concerned with recreational activities in which the listener might participate. Examples include, Gardening, Fishing, Antique collecting, Cooking, Food & Wine, etc.
JAZZ	Polyphonic, syncopated music characterised by improvisation.
COUNTRY	Songs which originate from, or continue the musical tradition of the American Southern States. Characterised by a straightforward melody and narrative story line.
NATION M	Current Popular Music of the Nation or Region in that country's language, as opposed to International 'Pop' which is usually US or UK inspired and in English.
OLDIES	Music from the so-called "golden age" of popular music.
FOLK M	Music which has its roots in the musical culture of a particular nation, usually played on acoustic instruments. The narrative or story may be based on historical events of the people.
DOCUMENT	Programme concerned with factual matters, presented in an investigative style.
TEST	Broadcast when testing emergency broadcast equipment or receivers.
ALARM !	Emergency announcement made under exceptional circumstances to give warning of events causing danger of general nature.
NONE	No programme type (receive only).
TP	Broadcasts which carry traffic announcements.
TA	Traffic announcements are being broadcast.

Note:

When you select a programme in the EON stand-by mode, the unit will display "TI" instead of "TA".



Using the Radio Data System (RDS) (continued)

■ Using the Auto Station Programme Memory (ASPM)

Whilst in the ASPM operation mode, the tuner will automatically search for new RDS stations. Up to 40 stations can be stored.

If you have already stored some stations in memory, the number of new stations you can store will be less.

1 Press the TUNER (BAND) button repeatedly to select "FM".

2 Press and hold down the ASPM button for at least 3 seconds.

1. After "ASPM" has flashed for about 4 seconds, scanning will start (87.50 - 108.00 MHz).

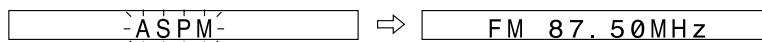

2. When an RDS station is found, "RDS" will appear first, and then the station will be stored in memory.

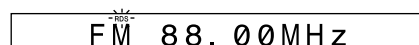

3. After scanning, the number of stations stored in memory will be displayed for 4 seconds.



To stop the ASPM operation before it is complete:

Press the ASPM button whilst it is scanning for stations.

The stations which are already stored in memory will be kept there.

Notes:

- If the same station is broadcasting on different frequencies, the strongest frequency will be stored in memory.
- Any station which has the same frequency as the one stored in memory will not be stored.
- If 40 stations have already been stored in memory, the scan will be aborted. If you want to redo the ASPM operation, erase the preset memory.
- If no stations have been stored in memory, "END" will appear for about 4 seconds.
- If the RDS signals are very weak, station names may not be stored in memory.

To erase all of the contents of preset memory:

Refer to "To clear all memorised stations" on page 23.

To correct a station name in memory:

It may be impossible to store station names in memory using the ASPM function if there is lots of noise or if the signal is too weak. In this case, perform as follows.

1. Press the ◀◀/▶▶ or ▶▶/▶▶ button to check whether the names are correct.
2. If you find a wrong name while receiving the station, wait until the correct name will be displayed. And then press the MEMORY/ENTER button.
3. Press the MEMORY/ENTER button whilst the preset channel number is flashing. (Within 5 seconds)
 - The new station name has been stored in memory correctly.

Notes:

- The same station name can be stored in different channels.
- In a certain area or during certain time periods, the station names may temporarily be different.



■ To recall stations in memory

To specify programmed types and select stations (PTY search):

You can search a station by specifying the programme type (news, sports, traffic programme, etc. ... see page 25) from the stations in memory.

1 Press the TUNER (BAND) button repeatedly to select "FM".

2 Press the PTY. TI button.

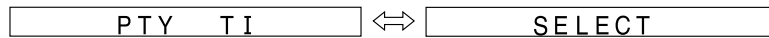

"PTY TI" and "SELECT" appear alternately.

3 Within 4 seconds, press the ◀◀/▶▶ or ▶▶/▶▶ button to select the programme type.

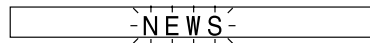

Each time the button is pressed, the programme type will appear. If the button is held down for more than 0.5 seconds, the programme type will appear continuously.

4 Whilst the selected programme type is flashing (within 4 seconds), press the PTY. TI button again.



After the selected programme type has been lit for 2 seconds, "SEARCH" will appear, and the search operation will start.

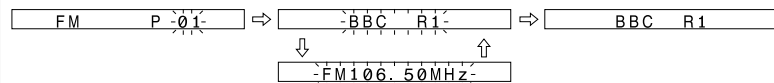

Notes:

- If the display has stopped flashing, start again from step 2. If the unit finds out a desired programme type, corresponding channel number and frequency will flash for about 2 seconds, and then the station name will flash for 7 seconds and remain lit.
- If you want to listen to the same programmed type of another station, press the PTY. TI button whilst the channel number or station name is flashing. The unit will look for the next station.
- If no station can be found, "NOT FOUND" will appear for 4 seconds.

If you select the traffic programme:

If you select the traffic programme (TP) in step 3, "TP" will appear. (This does not mean that you can listen to the traffic information at that time.)

When a traffic information is broadcast, "TA" will appear.



Using the Radio Data System (RDS) (continued)

■ To automatically play the desired programme (EON-PTY)

When the desired type of programme is broadcast, the radio switches to it automatically.

1 Tune in to an RDS station (when a station name is displayed).



2 Press the EON button when "EON" appears.

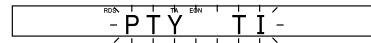

- "PTY TI" will flash for about 4 seconds.
- If the EON button is pressed when "EON" is not displayed, "NO EON" will appear for 4 seconds to indicate that the unit cannot enter the EON stand-by mode.

3 Whilst they are displayed, select the desired programme type by pressing the ◀◀/▶▶ or ▶▶/▶▶ button.



The selected programme type will flash.

4 Within 4 seconds, press the PTY. TI button.

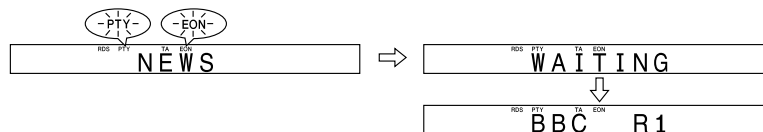

- The selected programme type and "WAITING" will be displayed for 2 seconds each.
- "PTY" will appear, and the unit will enter the EON-PTY stand-by mode.

5 When the specified programme starts on an ON (other network) station, the unit will automatically switch to the station and "PTY" will flash.



6 When the programme is over, the unit will automatically return to the original station.

Checking the stand-by mode setting:

When in the EON stand-by mode, press the EON button. ("Programme type" → "WAITING")

To cancel the EON stand-by mode:

When in the EON stand-by mode, press the EON button. Within 4 seconds, press it again. ("PTY" will go out.)



■ To automatically play the traffic information (EON-TI)

When the traffic information is broadcast, the radio switches to it automatically.

1 Tune in to an RDS station (when a station name is displayed).



2 Press the EON button when "EON" appears.

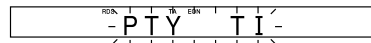

- "PTY TI" will flash for about 4 seconds.
- If the EON button is pressed when "EON" is not displayed, "NO EON" will appear for 4 seconds to indicate that the unit cannot enter the EON stand-by mode.

3 Whilst they are displayed, select the TI (Traffic Information) by pressing the ◀◀/▶▶ or ▶▶/▶▶ button.

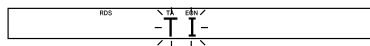

4 Within 4 seconds, press the PTY. TI button.

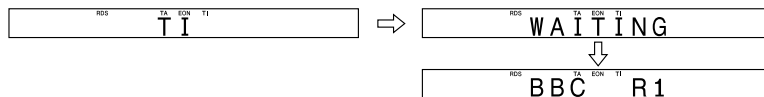

- "TI" and "WAITING" will appear for 2 seconds each.
- "TI" will appear, and the unit will enter the EON-TI stand-by mode.

5 When a TA specified starts on an ON (other network) station, the unit will automatically switch to that station, and "TI" will flash.



6 When the traffic information is over, the unit will automatically return to the original station.

Checking the stand-by mode setting:

When in the EON stand-by mode, press the EON button. ("TI" → "WAITING")

To cancel the EON stand-by mode:

When in the EON stand-by mode, press the EON button. Within 4 seconds, press it again. ("TI" will go out.)



Using the Radio Data System (RDS) (continued)

■ Notes for RDS operation

If any of the following events occur, it does not mean that the unit is faulty:

- "PS", "NO PS" and a station name appear alternately, and the unit does not operate properly.
- If a particular station is not broadcasting properly or a station is conducting tests, the RDS reception function may not work properly.
- When you receive an RDS station whose signal is too weak, information like the station name may not be displayed.
- "NO PS" or "NO PTY" will flash for about 5 seconds, and then the frequency will be displayed.

About the "TP" and "TA" indicators:

"TP"	"TA"	Meaning
Not lit	Not lit	Does not carry traffic announcements nor does it refer, via EON, to a programme that does.
Not lit	Lit	Carries EON information about another programme which gives traffic information.
Lit	Not lit	Carries traffic announcements but not at present and may also carry EON information about other traffic announcements.
Lit	Lit	A traffic information is currently on air.

In the following cases, the EON stand-by mode will be cancelled.

- When you press the ON/STAND-BY button to enter the stand-by mode.
- When the unit is switched to another band in the EON stand-by mode.
- When you change the FM station whilst in the EON stand-by mode.
- When a preset call is made.

Notes:

- Whilst the same programme as the specified PTY (or TA) is being broadcast, the unit will not switch to an ON (other network) station.
- If there are more than two ON stations, compare the strength of signal and tune in to the station with the strongest signal (EON-AF). If an ON station has been stored in the preset channel memory, the unit will switch to that channel.
- If you want to leave an ON station tuned in by the EON and return to the station you were receiving, press the EON button.
- After the unit returns to the original station, the stand-by mode will still be active. (The "TI" or "PTY" will remain lit.)
- The unit does not switch between ON stations. It returns to the original station.
- If there is any problem with the ON station the unit switched to, "WEAK SIGNAL" will appear and the unit will return to the original station.
- If the signal from the ON station the unit switched to is very weak, the unit will search for another station with the strongest signal. However, if the signals from all stations are weak or not good (due to electrical noise), the unit displays "WEAK SIGNAL" and returns to the original station.



Before Recording to a MiniDisc

MD-E9000H

■ Differences from tape recordings

You cannot record music on the reverse side of a MiniDisc.

MiniDiscs are single sided and should only be inserted with the correct side up.

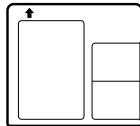

You do not need to search for the starting point of recording.

The unit automatically finds the point at which recording can start. Recording will start from that point.

You can check the total or remaining recordable time (possible recording) before recording.

This lets you plan a recording session so that the last song will not come to an abrupt end.

■ Disc writing (TOC)

The TOC (Table of Contents) is information on track numbers and recording areas to allow the unit to recognise musical selections or sounds.

The entire MiniDisc is controlled depending on this TOC, which enables the unit to find the beginning of a track quickly or to automatically record in a vacant area.

When you start recording or editing, "TOC" will appear in the display window.

This indicates that information in the TOC is now being changed according to the recording or editing being performed. (The changed TOC is not yet recorded on the MiniDisc at this time.)

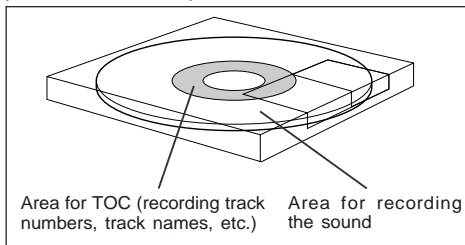

The TOC is recorded when

- you stop recording.
- you switch to another input source.
- you eject the MiniDisc.
- you enter the stand-by mode.

Do NOT unplug the unit whilst the TOC is being recorded ("TOC" is flashing) and do NOT impart shock to the unit. Otherwise, TOC will not be correctly recorded, and consequently proper playback may not be possible.

■ About track numbers

When recording from a CD

New track numbers will be created automatically according to the original tracks (Synchro mark function).

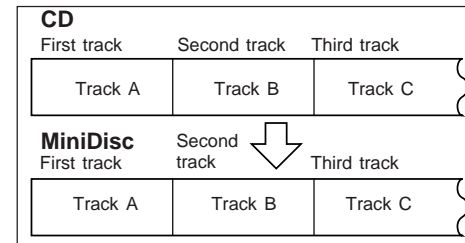

- When you record from a CD to a MiniDisc, the track numbers recorded on the MiniDisc may not match the track numbers on the CD. If this happens, correct the track numbers using the DIVIDE (page 38) and COMBINE (page 38) functions after recording.

Recordings cannot be made in the following situations.

- If you try recording on a playback-only MiniDisc (commercially available music MiniDisc).
- If a MiniDisc is protected against accidental erasure (page 45).
- If there is no more recording space left on the disc (page 46).
- When the "TOC FULL" message appears (page 46).
- If a disc's TOC has been damaged.

Notes:

- When recording important selections, be sure to make a preliminary test to ensure that the desired material is being properly recorded.
- The VOLUME, X-BASS and EQUALIZER controls can be adjusted with no effect to the recorded signal (Variable Sound Monitor).

■ About ATRAC 3

The ATRAC (Adaptive TRansform Acoustic Coding) system compresses the sound data into 1/5 by cutting out the inaudible sound. Since the sound is selected based on psychoacoustics masking, the sound quality is not impaired.

This unit is equipped with the ATRAC 3 compressing system that can reduce the sound data to 1/10 or 1/20 of its original size.

By employing this system, 2 times and 4 times long recordings are enabled in stereo mode.

MD Recording
- Before Recording to a MiniDisc -

10



Recording to a MiniDisc from a CD

■ Recording to a MiniDisc from a CD (One-Touch Editing)

A CD can be recorded to a MiniDisc, starting from the first track, with one-touch operation.

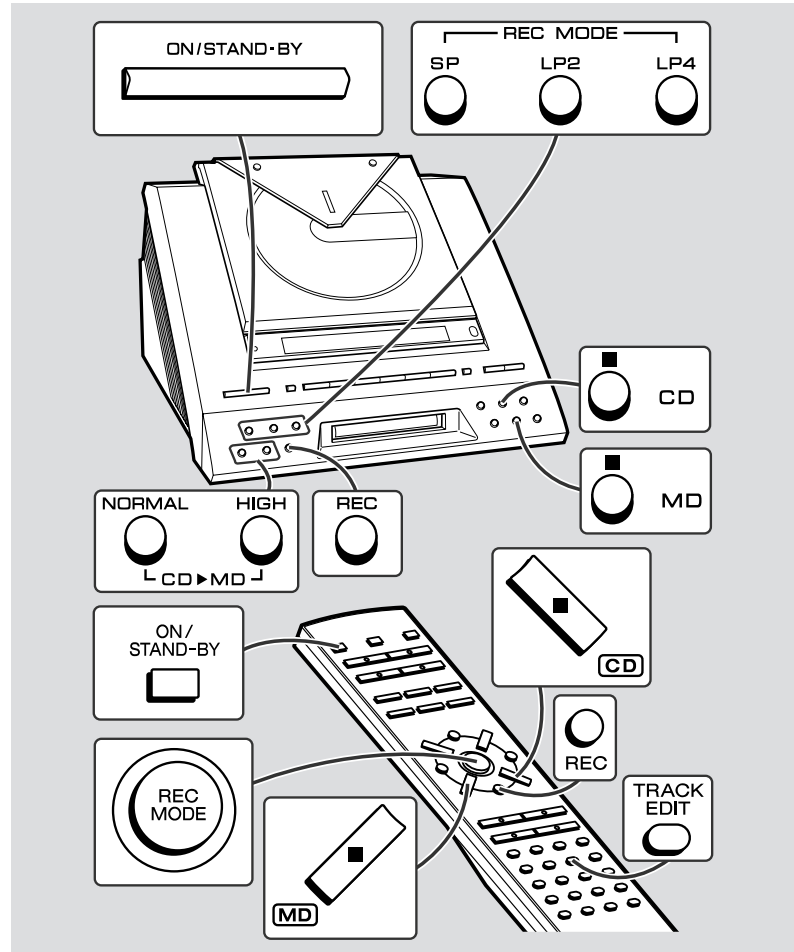

1 Press the ON/STAND-BY button to turn the power on.

2 Press the CD ■ button.

3 Load a CD and a recordable MiniDisc.

- The total number of tracks and the total playing time on the CD will be displayed.

4 Press the REC MODE button to select a recording mode.

Recording on 80-minute MD

SP: Stereo recording, maximum 80 minutes

LP2: 2 times long recording (stereo), maximum 160 minutes

LP4: 4 times long recording (stereo), maximum 320 minutes

- The recording mode cannot be changed whilst recording.
- The recording mode remains unchanged until another mode is selected.

5 Press the HIGH or NORMAL button.

- Press the NORMAL button for actual speed, HIGH for high-speed recording.

REC " TTL10 35 : 05

- Recording will begin, starting from the first track of CD.
- After recording (all of the tracks that can be recorded), the unit will stop automatically.

To check the remaining recording time:

Whilst in the stop mode, press one of the REC MODE buttons (SP, LP2 or LP4). The remaining time will be displayed according to the pressed REC MODE button.

To stop recording:

Press the MD ■ or CD ■ button.

- Playback and recording will stop and the track numbers will be written on the MiniDisc.

Caution:

- Check whether recording is performed or not with the level meters.
- When a damaged CD is recorded at high speed, the unit may stop whilst recording, or some noise or a drop out may be recorded. In this case, record the CD at normal speed.

**Notes:**

- When the CD playing time is longer than the available MiniDisc recording time, the recording process will not start even when the HIGH or NORMAL button is pressed.

REC "	TTL 10 35 : 05
Total number of recordable tracks (from the first track)	Available recording time

- To record as many tracks as possible, press the HIGH or NORMAL button again. Recording will start. However, when the MiniDisc runs out of space, "DISC FULL" will be displayed and the CD and MiniDisc will stop. If the available recording time on the MiniDisc is less than the length of the first track on the CD, recording will not be performed.

Note for high speed recording:

If the source CD is of poor quality due to scratches or dirt, recording at high speed may be unreliable, and it may be recorded with noise or pauses. If this occurs, set recording speed to normal.

Notes for long recording mode:

- Tracks recorded in 2 times long recording or 4 times long recording mode cannot be played with units that do not support these modes.
- On such a unit, "LP:" is displayed at the beginning of the track and no sound is heard. (The operation and the display may vary depending on the unit.)

Caution for 4 times long recording (LP4):

To realise 4 times long stereo recording, special compression methods are used. Due to the high levels of compression, the sound quality may be adversely affected and some noise may be recorded. If sound quality is the main concern, 2 times long or normal recording is recommended.

■ To record without using One-Touch Editing

1 Load a CD and a recordable MiniDisc.

2 Press the REC button.

- The unit will enter the recording stand-by mode.

3 Programme desired tracks from a CD (see page 19).

4 Press the CD ►|| button.

To stop recording:

Press the MD ■ button.

- Recording will stop and the track numbers will be written on the MiniDisc.



Recording to a MiniDisc from a CD (continued)

■ Recording the first several tracks of a CD

Create your own hit collection. For example, you can record the first several tracks of a CD.

1 Press the ON/STAND-BY button to turn the power on.

2 Press the CD ■ button.

3 Load a CD and a recordable MiniDisc.

4 Press the TRACK EDIT button.



5 Press the TRACK EDIT button repeatedly to select the last track number you want to record.



- If you select 21 tracks or more, "EDIT OVER" will be displayed.

6 Press the HIGH or NORMAL button.

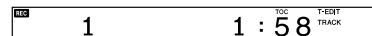

- The CD will be recorded in order, starting from the first track. When a MiniDisc runs out of recording space or when a CD has been completely recorded, the CD and the MiniDisc will stop automatically.

Note:

When repeat play has been set and you press the HIGH or NORMAL button, the repeat mode will be cancelled automatically and track editing will start.

To stop recording:

Press the MD ■ button.

- Playback and recording will stop and the track numbers will be written on the MiniDisc.

■ Programmed recording from a CD

1 Programme desired tracks from a CD (see page 19).

2 Load a recordable MiniDisc.

3 Press the HIGH or NORMAL button.

- Programmed playback will start, and recording will start automatically.
- Programmed tracks will be recorded in order. After the unit has finished recording the last track, recording will stop automatically.

Note:

When repeat play has been set and you press the HIGH or NORMAL button, the repeat mode will be cancelled automatically and programmed recording will start.

To stop recording:

Press the MD ■ button.

- Playback and recording will stop and the track numbers will be written on the MiniDisc.



Recording to a MiniDisc from the Radio

MD-E9000H

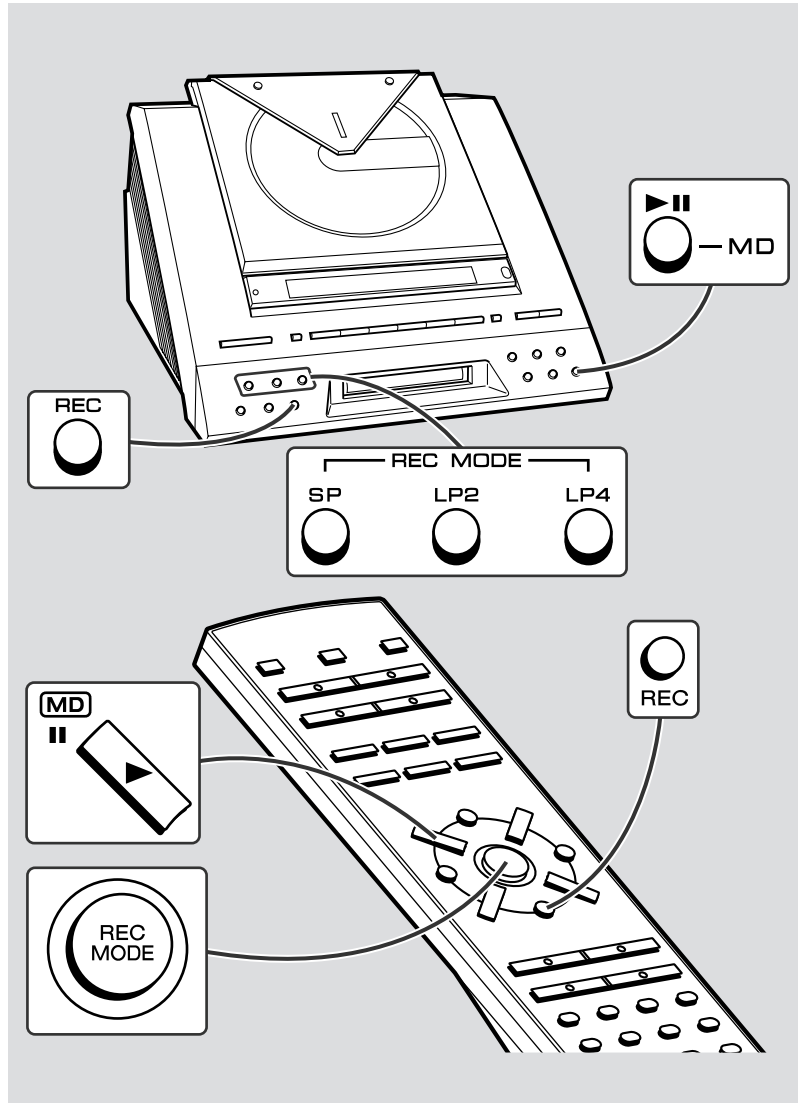

- 1** Tune in to a desired station (see page 22).
- 2** Load a recordable MiniDisc.
- 3** Select a recording mode by pressing one of the REC MODE buttons (SP, LP2, LP4).
 - At the same time, you can check the recordable time of the MD.
- 4** Press the REC button.
 - The unit will enter the recording stand-by mode.
- 5** Press the MD ►|| button.

Notes:

- Before recording an AM broadcast, enter the recording stand-by mode, and then separate the AM loop aerial from the main unit. Adjust it so that the AM broadcast can be tuned in most clearly.
- During recording, you cannot change stations.

To interrupt recording:

Press the MD ►|| button.
To resume recording, press the MD ►|| button again.

To stop recording:

Press the MD ■ button.
The recording will stop and the track number will be written on the MiniDisc.

To record the track number whilst recording:

The recording is performed as a single track.
To identify different sections of a recording, you can increase the track number at any point during the recording process by pressing the REC button.

- The track number will increase by one, and then the recording will continue.

MD Recording
- Recording to a MiniDisc from the Radio -



Titling a MiniDisc

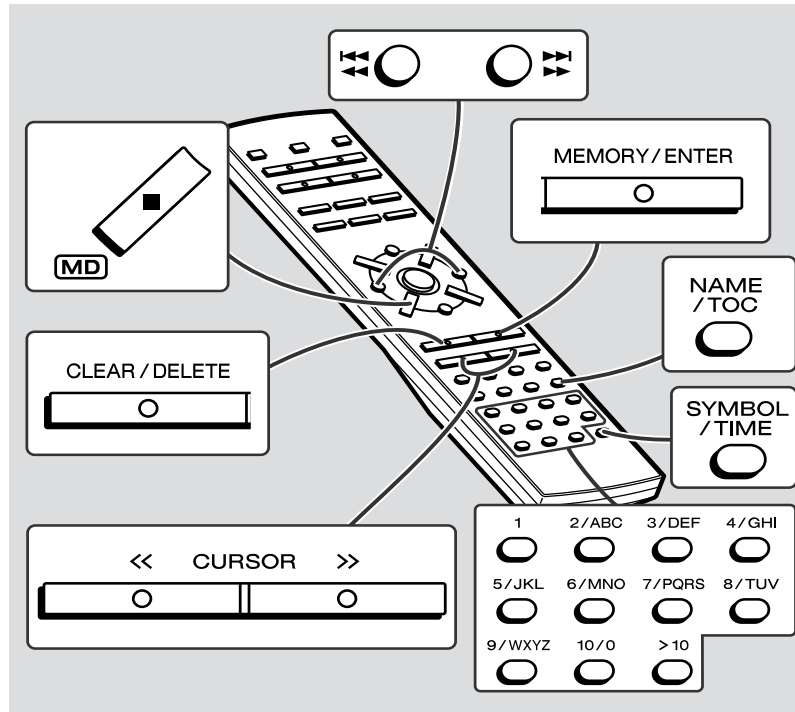

■ Creating disc and track names

You can give a name to discs and tracks.
One disc name and up to 255 track names can be created per disc (a maximum of 40 characters for the disc and each track name and a total of 1,700 characters can be entered).

- Playback-only MiniDiscs cannot be edited.

1 Press the MD ■ button and load a MiniDisc (see page 17).

Disc name	Track name
Whilst in the stop mode of MiniDisc, press the NAME/TOC button, and select "DISC NAME" using the ◀◀/◀◀ or ▶▶/▶▶ button.	During playback or in the pause mode of MiniDisc, press the NAME/TOC button, and select "TRACK NAME" using the ◀◀/◀◀ or ▶▶/▶▶ button.

DISC NAME	TRACK NAME
-----------	------------

3 Within 10 seconds, press the MEMORY/ENTER button.

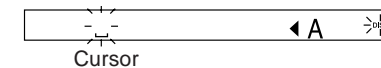

- The unit will enter the character input mode.
- To cancel the operation, press the MD ■ button.

4 Press the 1 - 10, SYMBOL/TIME and >10 buttons to enter characters.

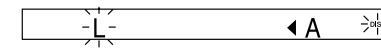

- The >10 button allows switching between capital and small letters.
- You can enter symbols by pressing the SYMBOL/TIME button (see page 37).

5 When the name has been entered, press the MEMORY/ENTER button.

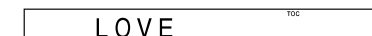



To erase disc and track names:

1. Perform steps 1 - 3 in the "Creating disc and track names" section on page 36.
2. Press the CLEAR/DELETE button for 2 seconds or more.
 - "NAME CLEAR?" appears.
3. Press the MEMORY/ENTER button.

To delete a character:

1. Perform steps 1 - 3 in the "Creating disc and track names" section on page 36.
2. Press the CURSOR (<< or >>) button to flash the character to delete.
3. Press the CLEAR/DELETE button.
4. Press the MEMORY/ENTER button.

To add a character:

1. Perform steps 1 - 4 in the "Creating disc and track names" section on page 36.
2. Press the CURSOR (<< or >>) button to flash the character before which you want to add a new character.
3. Select a character to enter and press the MEMORY/ENTER button.
4. Press the MEMORY/ENTER button again.

To change a character:

Example) To change "LAVE SONG" to "LOVE SONG"

1. Perform steps 1 - 4 in the "Creating disc and track names" section on page 36.
2. Press the CURSOR (<< or >>) button to flash the character to change.

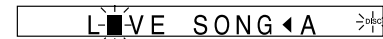

3. Press the CLEAR/DELETE button.

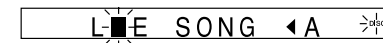

4. Select a character to enter and press the MEMORY/ENTER button.

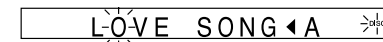

5. Press the MEMORY/ENTER button again.

Characters (symbols):

>10	1	2/ABC	3/DEF	4/GHI	5/JKL	6/MNO	7/PQRS	8/TUV	9/WXYZ	10/0
Capital letters 	1	ABC 2	DEF 3	GHI 4	JKL 5	MNO 6	PQRS 7	TUV 8	WXYZ 9	0
	1	abc 2	def 3	ghi 4	jkl 5	mno 6	pqrs 7	tuv 8	wxyz 9	0
SYMBOL / TIME 	- . , / : ? & () ! " # \$ % * ; < = > @ _ ` + '									

: indicates a space.



Editing a Recorded MiniDisc

■ To divide a track

- 1 Press the MD ■ button and load a MiniDisc (see page 17).
- 2 Play the track which you want to divide into two, and press the MD ►|| button at the point where you want to divide the track.
- 3 Press the NAME/TOC button, and within 10 seconds, select "DIVIDE" using the ◀◀/▶▶ or ▶▶/▶▶ button.

D I V I D E

- 4 Within 10 seconds, press the MEMORY/ENTER button.

D I V I D E O K ?

- To cancel the operation, press the MD ■ button.

- 5 Press the MEMORY/ENTER button again.
 - The track is divided, and the unit is stopped at the beginning of the second track.
 - The numbers of the tracks which come after the divided track are automatically increased by one.

Notes:

- The two new tracks will have the same name. However, in the TOC FULL condition, the second track may not be named.
- Each disc can hold up to 255 tracks. However, even if the number of assigned tracks has not reached 255, it might not be possible to make any further divisions of tracks.
- This function cannot be used in the random or programmed play mode.

■ To combine tracks

- 1 Press the MD ■ button and load a MiniDisc (see page 17).
- 2 Whilst in the stop mode, select the second of the two adjacent tracks you want to combine using the ◀◀/▶▶ or ▶▶/▶▶ button. Or start playing the second track and then press the MD ►|| button.
- 3 Press the NAME/TOC button, and within 10 seconds, select "COMBINE" using the ◀◀/▶▶ or ▶▶/▶▶ button.

C O M B I N E

- 4 Within 10 seconds, press the MEMORY/ENTER button.

2 + 3 ?

- To cancel the operation, press the MD ■ button.

- 5 Press the MEMORY/ENTER button again.
 - The two tracks are combined, and the unit is stopped at the beginning of the combined track.
 - The numbers assigned to the tracks following the combined track are automatically decreased by one.

Notes:

- When you want to combine two non-adjacent tracks, put them next to each other using the MOVE function and combine them using the COMBINE function.
- The first track name will be used. When it is not titled, the second track name will be used.
- This function cannot be used in the random or programmed play mode.

In the following cases, tracks may not be combined.

- Digital recorded track and analogue recorded track.
- Long play recorded track and stereo recorded track.
- Tracks whose recording time is less than 12 seconds.



■ To move a track

- 1** Press the MD ■ button and load a MiniDisc (see page 17).
- 2** Whilst in the stop mode, select the track you want to move using the ◀◀/▶▶ or ▶▶/▶▶ button. Or start playing the track and then press the MD ▶|| button.
- 3** Press the NAME/TOC button, and within 10 seconds, select "MOVE" using the ◀◀/▶▶ or ▶▶/▶▶ button.

MOVE
- 4** Within 10 seconds, press the MEMORY/ENTER button.

4 → 1 ?
- 5** Select a new track position using the ◀◀/▶▶ or ▶▶/▶▶ button.

4 → 11 ?

 - To cancel the operation, press the MD ■ button.
- 6** Press the MEMORY/ENTER button again.
 - The track is moved, and the unit is stopped at the beginning of the moved track.

Notes:

- When a track has been moved, the other tracks will be newly numbered automatically.
- This function cannot be used in the random play mode.

■ To move programmed tracks (programmed move)

- 1** Programme tracks in the desired order (steps 1-5, page 19).

8 34 : 25 TRACK MEMORY
- 2** Press the NAME/TOC button, and within 10 seconds, select "PRGM MOVE" using the ◀◀/▶▶ or ▶▶/▶▶ button.

PRGM MOVE MEMORY
- 3** Within 10 seconds, press the MEMORY/ENTER button.

PRGM MOVE? MEMORY

 - To cancel the operation, press the NAME/TOC button or MD ■ button.
- 4** Press the MEMORY/ENTER button again.
 - The tracks will be moved, and the unit will exit the programmed move mode.

Notes:

- The tracks that are not included in the programmed selections will be put at the end of the new track numbers.
- If a track has been programmed more than once, the initial programme position will have priority.



Editing a Recorded MiniDisc (continued)

■ To erase a track

- 1 Press the MD ■ button and load a MiniDisc (see page 17).
- 2 Whilst in the stop mode, select the track you want to erase using the ◀◀/▶▶ or ▶▶/▶▶ button. Or start playing the track and then press the MD ▶▶ button.
- 3 Press the NAME/TOC button, and within 10 seconds, select "ERASE" using the ◀◀/▶▶ or ▶▶/▶▶ button.

ERASE
- 4 Within 10 seconds, press the MEMORY/ENTER button.

ERASE 5?

 - To cancel the operation, press the MD ■ button.
- 5 Press the MEMORY/ENTER button again.
 - The track is erased, and the unit is stopped at the beginning of the next track.
- 6 To erase other tracks, repeat steps 1 - 5.

Notes:

- When a track is erased, the numbers assigned to the tracks following the erased track will be automatically decreased by one.
- When a track is erased, the track name will be erased at the same time.
- This function cannot be used in the random play mode.

■ To erase programmed tracks (programmed erase)

You can erase several tracks at once.

- 1 Programme them (steps 1 - 5, page 19).
- 2 Press the NAME/TOC button, and select "PRGM ERASE" using the ◀◀/▶▶ or ▶▶/▶▶ button.
- 3 When "PRGM ERASE?" appears, press the MEMORY/ENTER button twice.

■ To erase all of the tracks at once

- 1 Press the MD ■ button and load a MiniDisc (see page 17).
- 2 Whilst in the stop mode, press the NAME/TOC button, and within 10 seconds, select "ALL ERASE" using the ◀◀/▶▶ or ▶▶/▶▶ button.

ALL ERASE
- 3 Within 10 seconds, press the MEMORY/ENTER button.

ERASE OK?

 - To cancel the operation, press the MD ■ button.
- 4 Press the MEMORY/ENTER button again.

COMPLETE ^{TOC} ⇒ BLANK MD ^{TOC}

 - All of the track numbers and track names will be erased.

Note:

This function cannot be used in the random play mode.

Caution:

Once a track has been erased, it cannot be recovered. Check the track number before erasing it.



Timer and Sleep Operation

MD-E9000H

■ Timer playback/Timer recording

- Before setting the timer, press the CLOCK button to check that the clock is on time.

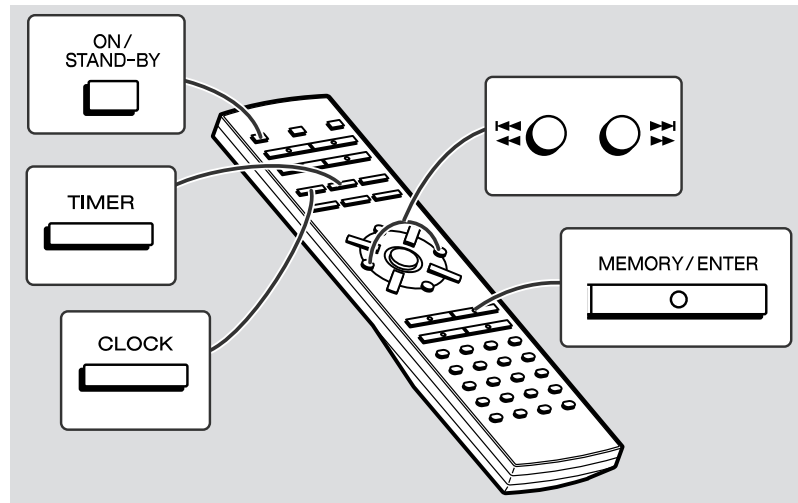

1 Press the ON/STAND-BY button to turn the power on and press the TIMER button.

2 Within 10 seconds, select "TIMER SET" with the **◀◀/▶▶** or **▶▶/▶▶** button.

TIMER SET

3 Within 10 seconds, press the MEMORY/ENTER button.

-TIMER PLAY-

4 Select timer playback or timer recording by using the **◀◀/▶▶** or **▶▶/▶▶** button, and then press the MEMORY/ENTER button.

-TIMER PLAY- ↔ -TIMER REC-

5 Press the **◀◀/▶▶** or **▶▶/▶▶** button to specify the hour to start, and then press the MEMORY/ENTER button.

ON AM 1:00

6 Press the **◀◀/▶▶** or **▶▶/▶▶** button to specify the minutes to start, and then press the MEMORY/ENTER button.

ON AM 1:15

7 Press the **◀◀/▶▶** or **▶▶/▶▶** button to specify the hour to stop, and then press the MEMORY/ENTER button.

OFF AM 2:15

8 Press the **◀◀/▶▶** or **▶▶/▶▶** button to specify the minutes to stop, and then press the MEMORY/ENTER button.

OFF AM 2:00

9 Select the desired function by using the **◀◀/▶▶** or **▶▶/▶▶** button, and then press the MEMORY/ENTER button.

When you select the tuner, select a station by pressing the **◀◀/▶▶** or **▶▶/▶▶** button, and then press the MEMORY/ENTER button.

10 Adjust the volume using the **◀◀/▶▶** or **▶▶/▶▶** button.

11 Press the MEMORY/ENTER button.

- Your system will enter the power stand-by mode and the TIMER indicator will light.

When the start time is reached, playback or recording will start.
When the timer end time is reached, timer operation will stop.



Timer and Sleep Operation (continued)

Notes:

- The timer cannot control the component connected to the auxiliary input sockets.
- When the CD or MiniDisc is over, playback will stop before the stop time.
If you wish to play to the stop time, set repeat play for the CD or MiniDisc.
- Timer playback and timer recording cannot be set at the same time.

To confirm the timer setting:

1. Whilst in the timer stand-by mode, press the TIMER button.
2. Within 10 seconds, press the ◀◀/◀◀ or ▶▶/▶▶ button to select "TIMER CALL".
3. Press the MEMORY/ENTER button.

After the settings are displayed sequentially, your system will return to the timer stand-by mode.

To cancel the timer operation:

Whilst in the timer stand-by mode, press the ON/STAND-BY button to turn the power on. The timer operation will be cancelled.

You can also cancel the timer operation by the following steps without turning on the power.

1. Press the TIMER button.
2. Within 10 seconds, press the ◀◀/◀◀ or ▶▶/▶▶ button to select "CANCEL".
3. Press the MEMORY/ENTER button.

Caution:

In the following cases, the timer recording function will not work.

- When a MiniDisc has not been inserted.
- When the MiniDisc is for playback only or protected against accidental erasure.
- When there is no recording space left on the MiniDisc ("TOC FULL " or "DISC FULL" appears).

■ Sleep operation

The radio, CD and MiniDisc can all be turned off automatically.

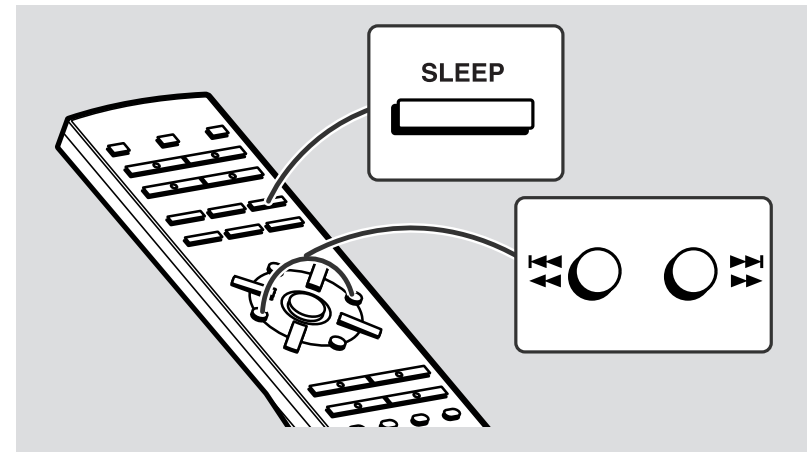

1 Play the desired sound source.

2 Press the SLEEP button.

SLEEP 1 : 00

3 Within 10 seconds, press the MEMORY/ENTER button.

4 Press the ◀◀/◀◀ or ▶▶/▶▶ button to select the time.

(Maximum: 2 hours - Minimum: 1 minute)

The amount of sleep time can also be changed during the sleep operation.

SLEEP 30



5 Press the MEMORY/ENTER button to set the sleep time.

6 The unit will enter the stand-by mode automatically after the pre-set sleep time has elapsed.

To cancel the sleep operation:

Setting the unit to the power stand-by mode cancels the sleep operation. You can also cancel the sleep operation by the following steps without setting the unit to the power stand-by mode.

1. Whilst in the sleep operation, press the SLEEP button.
2. Within 10 seconds, press the MEMORY/ENTER button. "SLEEP" indicator will go out.

To confirm the remaining sleep time:

1. Whilst in the sleep operation, press the SLEEP button.
 2. Within 10 seconds, press the ◀◀/▶▶ or ▶▶/▶▶ button to select "SLEEP". The remaining sleep time will be displayed.
- After 10 seconds, the display will return to normal.
 - If you press the MEMORY/ENTER button whilst the remaining sleep time is displayed, you can change the sleep time. (Perform steps 4 and 5 above.)

Notes:

- Once the sleep time is set, it will remain unchanged until a new time is entered.
- The sleep functions cannot be used to control the device connected to this unit. You must use its sleep functions, if it has them.

■ Simultaneous sleep and timer operation

1 Perform steps 1 - 3 on pages 42 - 43, "Sleep operation".

2 Perform steps 1 - 11 on page 41, "Timer playback/Timer recording".

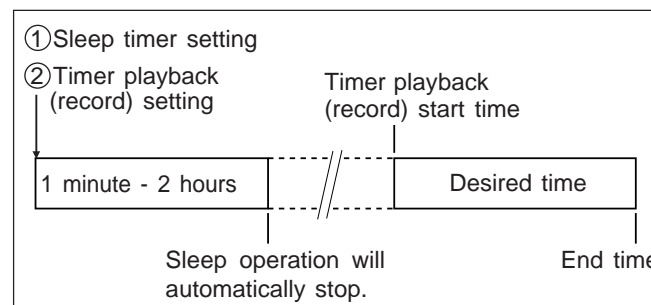



Enhancing Your Stereo System

The connection cable is not included. Purchase a commercially available cable as shown below.

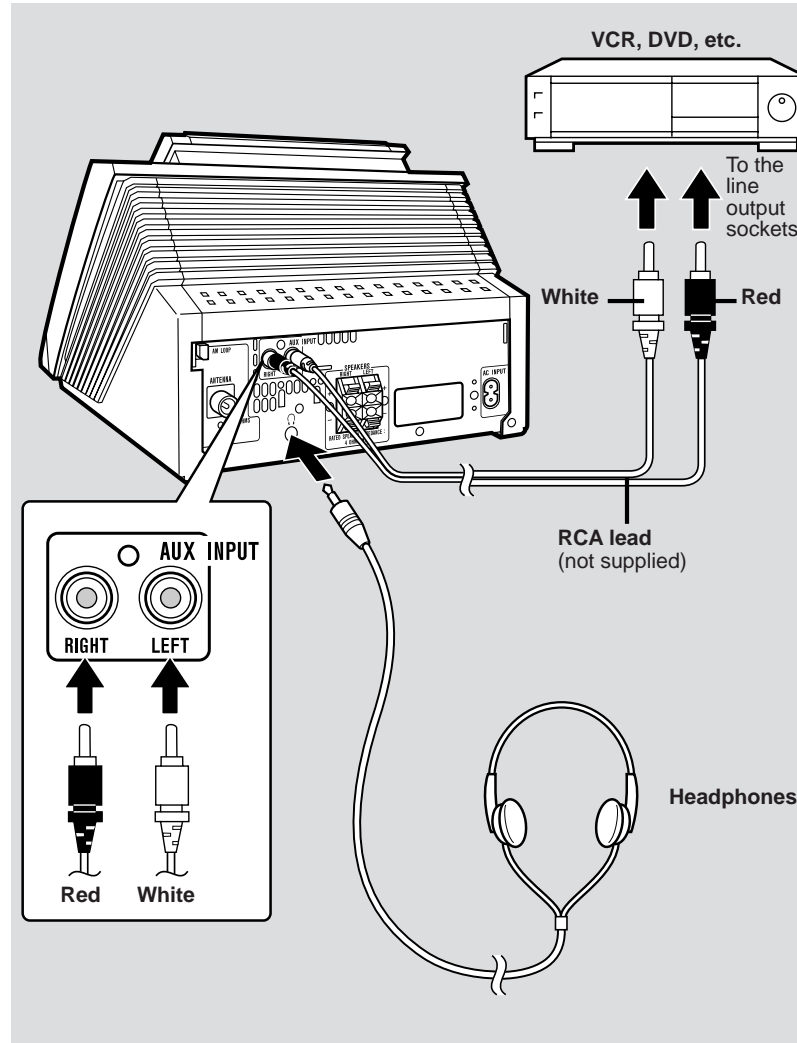

■ Listening to the playback sounds from the connected device

1. Use a connection cable to connect an external device to the AUX INPUT sockets. When using video equipment, connect the audio output to this unit and the video output to a television.
2. Press the ON/STAND-BY button to turn the power on.
3. Press the AUX button or the VIDEO/AUX button on the remote control.
4. Start playback on the external device.
5. Adjust the input level using the TUNING (∨ or ∧) button.



6. Adjust the volume using the VOLUME buttons.

■ Recording on a MiniDisc

1. Use a connection cable to connect an external device to the AUX INPUT sockets.
2. Press the ON/STAND-BY button to turn the power on.
3. Press the AUX button.
4. Load a recordable MiniDisc.
5. Press the REC button.
6. Start playback on the external device.
7. Adjust the recording level using the TUNING (∨ or ∧) button.
8. Press the A-MARK button on the remote control to activate/deactivate the auto mark function.
 - If you turn on the auto mark function, the unit pauses when a silence lasts for 1 second or more, and creates a track number.
9. Press the MD ►|| button.

To stop recording:

Press the MD ■ button.

■ Headphones

- Before plugging in or unplugging the headphones, reduce the volume.
- Be sure your headphones have a 3.5 mm (1/8") diameter plug and are between 16 ohms and 50 ohms impedance. The recommended impedance is 32 ohms.
- Plugging in the headphones disconnects the speakers automatically. Adjust the volume using the VOLUME buttons.



What is a MiniDisc?

The disc is stored in a cartridge. You can handle it easily without worrying about dust, fingerprints, etc. However, dust entering the opening of the cartridge, dirt on the cartridge, warping, etc. may cause malfunctions. Please note the following.

To prevent recorded MiniDiscs from being erased accidentally

Slide the accidental erase prevention tab, located on the side of the MiniDisc, in the direction indicated by the arrow.

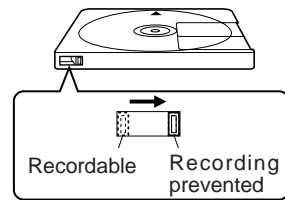

To add a recording, slide the tab back to its original position.

Helpful tip when attaching a label

If the label is not attached properly, the MiniDisc may jam inside the unit and it may not be possible to remove it.

- If the label peels off or partially lifts away, replace it with a new one.
- Do not put a new label on top of an existing one.
- Attach the label only in the specified location.



Types of discs

There are two types of discs.

● Playback-only MiniDisc:

This type of MiniDisc is used for commercially available prerecorded music. This is the same kind of optical disc as CDs. Playback is performed using an optical pickup. (Recording and editing are not possible.)

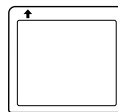

A shutter will be used on only one side (back).

● Recordable MiniDisc:

This is a "raw disc" on which recording can be performed. A magneto optical disc is used. Recordings are made using a laser and magnetic field. Repeated recording is possible.

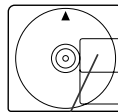

Shutters will be used on both sides.

MiniDisc System Limitations

MD-E9000H

Even if the maximum recording time of a MiniDisc has not been reached, "TOC FULL" may be displayed.	In the MD system, the delimiter of the recording area on a MiniDisc is programmed in a TOC. If partial erasing, recording and editing are repeated several times, TOC information will fill up, even though the number of tracks has not reached the limit (255 tracks), and further recording will be impossible. (If you use the all erase function, this MiniDisc can be used from the beginning.)
Even if the maximum recording time of a MiniDisc has not been reached, "DISC FULL" may be displayed.	If there is any flaw on the MiniDisc, that part is automatically excluded from the space available for recording. Therefore, the recording time becomes shorter.
Even if several short tracks are erased, the remaining recording time may not show an increase.	When the remaining recording time of a disc is displayed, short tracks less than 12 seconds long may not be included in the total.
Two tracks may not be combined in editing.	For MiniDiscs on which repeated recording and editing operations were performed, the COMBINE function may not work. A track recorded from a CD (digital recording) and a track recorded from a radio or other equipment (analogue recording) cannot be combined.
The total of the recorded time and time remaining on a disc may not add up to the maximum possible recording time.	A cluster (about 2 seconds) is normally the minimum unit of recording. So, even if a track is less than 2 seconds long, it will use about 2 seconds of space on the disc. Therefore, the time actually available for recording may be less than the remaining time displayed. If there are scratches on discs, those sections will be automatically avoided (no recording will be placed in those sections). Therefore, the recording time will be reduced.
If recorded tracks are fast reversed or fast forwarded, the sound may skip.	A MiniDisc which has been recorded or edited repeatedly may skip during fast reverse or fast forward.



Error Messages

When an error message is displayed, proceed as follows:

Error messages	Meaning	Remedy
BLANK MD	<ul style="list-style-type: none"> ● Nothing is recorded. (Neither music nor disc name is recorded.) 	<ul style="list-style-type: none"> ● Replace it with another disc.
Can't COPY	<ul style="list-style-type: none"> ● You tried to record from a copy prohibited CD. 	<ul style="list-style-type: none"> ● Replace the CD.
Can't EDIT	<ul style="list-style-type: none"> ● A track cannot be edited. 	<ul style="list-style-type: none"> ● Change the stop position of the track and then try editing it.
Can't READ * (* :Number or symbol)	<ul style="list-style-type: none"> ● The disc is damaged. ● TOC information cannot be read. ● MiniDisc not specified. 	<ul style="list-style-type: none"> ● Replace it with another disc. ● Erase the disc and try recording again.
Can't REC	<ul style="list-style-type: none"> ● Recording cannot be performed correctly due to vibration or shock in the unit. 	<ul style="list-style-type: none"> ● Re-record or replace the MiniDisc.
Can't WRITE	<ul style="list-style-type: none"> ● The TOC information could not be created properly due to a mechanical shock or to scratches on the disc. 	<ul style="list-style-type: none"> ● Set this unit to the stand-by mode and try to write the TOC again. (Remove any source of shock or vibration whilst writing.)
DISC FULL	<ul style="list-style-type: none"> ● The disc is out of recording space. 	<ul style="list-style-type: none"> ● Replace the disc with another recordable disc.
Er-CD 20	<ul style="list-style-type: none"> ● The CD cover is not working properly. 	<ul style="list-style-type: none"> ● Set this unit to the stand-by mode and turn the power on again.
Er-MD ** (* :Number or symbol)	<ul style="list-style-type: none"> ● MiniDisc is not working properly. 	<ul style="list-style-type: none"> ● Set this unit to the stand-by mode and turn the power on again.
EDIT OVER	<ul style="list-style-type: none"> ● You chose 21 or more tracks for track editing. ● The remaining time available for recording is short. 	<ul style="list-style-type: none"> ● Decrease the number of tracks. ● Replace it with a disc that has enough time to record.
MD NO DISC CD NO DISC	<ul style="list-style-type: none"> ● A MiniDisc has not been loaded. ● The MiniDisc data cannot be read. ● A CD has not been loaded. ● The CD data cannot be read. 	<ul style="list-style-type: none"> ● Load a MiniDisc. ● Reload the MiniDisc. ● Load a CD. ● Reload the CD.

Error messages	Meaning	Remedy
NAME FULL	<ul style="list-style-type: none"> ● The number of characters for the disc name or track name exceeds 40. 	<ul style="list-style-type: none"> ● Shorten the disc or track name.
NOT AUDIO	<ul style="list-style-type: none"> ● The data recorded on this disc is not audio data. 	<ul style="list-style-type: none"> ● Select another track. ● Replace the disc.
PLAYBACK MD	<ul style="list-style-type: none"> ● You tried to record on a playback-only disc. 	<ul style="list-style-type: none"> ● Replace it with another recordable disc.
PROTECTED	<ul style="list-style-type: none"> ● The disc is write protected. 	<ul style="list-style-type: none"> ● Move the write protection tab back to its original position.
TEMP OVER	<ul style="list-style-type: none"> ● The temperature is too high. 	<ul style="list-style-type: none"> ● Set this unit to the stand-by mode and wait for a whilst.
TOC FORM ** (* :Number or symbol)	<ul style="list-style-type: none"> ● TOC information recorded on the MD does not match the MiniDisc specifications or it cannot be read. 	<ul style="list-style-type: none"> ● Replace it with another disc. ● Erase the disc and try recording again.
TOC FULL	<ul style="list-style-type: none"> ● There is no space left for recording track numbers. 	<ul style="list-style-type: none"> ● Replace it with another recordable disc.
TOC FULL1	<ul style="list-style-type: none"> ● There is no space left for recording character information. 	<ul style="list-style-type: none"> ● Replace it with another recordable disc. ● Erase the needless characters.
? MD DISC	<ul style="list-style-type: none"> ● The data contains an error. ● MiniDisc not specified. 	<ul style="list-style-type: none"> ● Replace it with another disc.
POWER?	<ul style="list-style-type: none"> ● MiniDisc is not working properly. 	<ul style="list-style-type: none"> ● Set this unit to the stand-by mode and turn the power on again.
ER-TU ** (* :Number or symbol)	<ul style="list-style-type: none"> ● Tuner is not working properly. 	<ul style="list-style-type: none"> ● Set the unit to the stand-by mode and turn the power on again.



Troubleshooting Chart

MD-E9000H

Many potential "problems" can be resolved by the owner without calling a service technician. If something is wrong with this product, check the following before calling your authorised SHARP dealer or service centre.

■ General

Symptom	Possible cause
<ul style="list-style-type: none"> The clock is not on time. 	<ul style="list-style-type: none"> Did a power failure occur? Reset the clock. (Refer to page 14.)
<ul style="list-style-type: none"> When a button is pressed, the unit does not respond. 	<ul style="list-style-type: none"> Set this unit to the power stand-by mode and then turn it back on. Does the unit still malfunction? Reset it. (Refer to page 48.)
<ul style="list-style-type: none"> No sound is heard from the speakers. 	<ul style="list-style-type: none"> Is the volume level set to "0"? Are the headphones connected? Are the speaker wires disconnected?

■ CD player

Symptom	Possible cause
<ul style="list-style-type: none"> Playback does not start. Playback stops in the middle or is not performed properly. 	<ul style="list-style-type: none"> Is the disc loaded upside down? Does the disc dissatisfy the standards? Is the disc distorted or scratched?
<ul style="list-style-type: none"> Playback sounds are skipped, or stopped in the middle of a track. 	<ul style="list-style-type: none"> Is the unit located near excessive vibration? Is the disc very dirty? Has condensation formed inside the unit?

■ MiniDisc

Symptom	Possible cause
<ul style="list-style-type: none"> A recording cannot be made. 	<ul style="list-style-type: none"> Is the MiniDisc protected against accidental erasure? Did you try to make recording on a playback-only MiniDisc? Can you see the "DISC FULL" or "TOC FULL" message in the display?
<ul style="list-style-type: none"> Even though a disc has been loaded, "CD/MD NO DISC" or "Can't READ" is displayed. Playback sounds are skipped. 	<ul style="list-style-type: none"> Is the unit located near excessive vibration? Is the disc very dirty? Has condensation formed inside the unit?

■ Tuner

Symptom	Possible cause
<ul style="list-style-type: none"> Radio makes unusual noise consecutively. 	<ul style="list-style-type: none"> Is the stereo system placed near the TV or computer? Is the AC power lead located near the aerial?

■ Remote control

Symptom	Possible cause
<ul style="list-style-type: none"> The remote control does not operate. 	<ul style="list-style-type: none"> Is the stereo system unplugged? Is the battery polarity incorrect? Are batteries dead? Is the distance or angle incorrect? Does the remote control sensor receive strong light?

■ Condensation

Sudden temperature changes, storage or operation in an extremely humid environment may cause condensation inside the cabinet (CD/MD pickup, etc.) or on the transmitter on the remote control.

Condensation can cause the unit to malfunction.

If this happens, leave the power on with no disc in the unit until normal playback is possible (about 1 hour). Wipe off any condensation on the transmitter with a soft cloth before operating the unit.

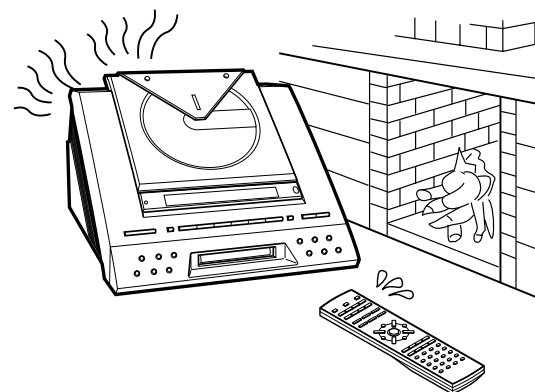



Troubleshooting Chart (continued)

■ If trouble occurs

When this product is subjected to strong external interference (mechanical shock, excessive static electricity, abnormal supply voltage due to lightning, etc.) or if it is operated incorrectly, it may malfunction.

If such a problem occurs, do the following:

1. Set the unit to the stand-by mode and turn the power on again.
2. If the unit is not restored in step 1, unplug and plug in the unit, and then turn the power on.

Note:

If neither operation above restores the unit, clear all the memory by resetting it.

■ Clearing all the memory (reset)

1. Press the ON/STAND-BY button to enter the power stand-by mode.
2. Whilst pressing down the PRESET \wedge button and the DISPLAY (DEMO) button, press the ON/STAND-BY button.
After the "RESET" is displayed for about 1 second, the unit will enter the power stand-by mode.

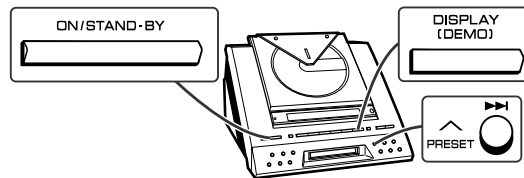

Caution:

This operation will erase all data stored in memory including clock, timer settings, tuner preset, and CD or MiniDisc programme.

■ Before transporting the unit

Remove the CD and the MiniDisc from the unit. Your unit checks whether there is a disc inside the unit when the compartment is closed. "NO DISC" appears if no disc is left. Then, set the unit to the power stand-by mode. Carrying the unit with discs left inside can damage it.

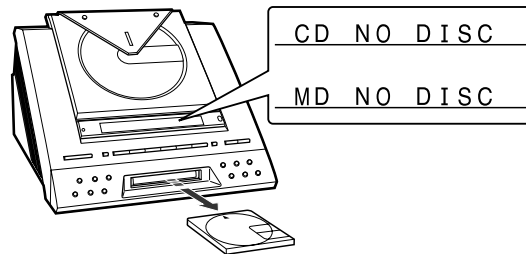

Maintenance

■ Cleaning the CD pickup lens

Do not touch the laser pickup lens. If fingerprints or dust accumulate on the pickup, clean it gently with a dry cotton swab.

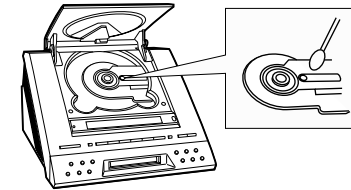

■ Cleaning the cabinet

Periodically wipe the cabinet with a soft cloth and a diluted soap solution, then with a dry cloth.

Caution:

- Do not use chemicals for cleaning (petrol, paint thinner, etc.). It may damage the cabinet finish.
- Do not apply oil to the inside of the unit. It may cause malfunctions.





Specifications

MD-E9000H

As part of our policy of continuous improvement, SHARP reserves the right to make design and specification changes for product improvement without prior notice. The performance specification figures indicated are nominal values of production units. There may be some deviations from these values in individual units.

■ General

Power source	AC 230 V, 50 Hz
Power consumption	Power on: 50 W Power stand-by: 0.6 W (*)
Dimensions	Width: 230 mm (9-1/16") Height: 173 mm (6-13/16") Depth: 290 mm (11-7/16")
Weight	4.1 kg (9.0 lbs.)

(*) This power consumption value is obtained when the demonstration mode is cancelled in the power stand-by mode. Refer to page 12 to cancel the demonstration mode.

■ Amplifier

Output power	MPO: 66 W (33 W + 33 W) (10 % T. H. D.) RMS: 40 W (20 W + 20 W) (10 % T. H. D.) RMS: 28 W (14 W + 14 W) (1kHz 0.9 % T. H. D.)
Output terminals	Speakers: 4 ohms Headphones: 16 - 50 ohms (recommended: 32 ohms)
Input terminals	Auxiliary: 500 mV/47 kohms

■ CD player

Type	Compact disc player
Signal readout	Non-contact, 3-beam semiconductor laser pickup
D/A converter	1-bit D/A converter
Frequency response	20 - 20,000 Hz
Dynamic range	90 dB (1 kHz)

■ MiniDisc

Type	MiniDisc recorder
Signal readout	Non-contact, 3-beam semiconductor laser pickup
Rotation speed	400 - 900 rpm CLV, Approx.
Error correction	ACIRC (Advanced Cross Interleave Reed-Solomon Code)
Quantization	20-bit linear (A/D converter)
Coding	ATRAC/ATRAC 3 (Adaptive TRansform Acoustic Coding)
Sampling frequency	44.1 kHz
Recording method	Magnetic modulation overwrite method
Frequency response	20 - 20,000 Hz
D/A converter	1-bit D/A converter
Wow and flutter	Unmeasurable (less than 0.001% W. peak)
Signal/noise ratio	95 dB (1 kHz)
Dynamic range	90 dB (1 kHz)
Audio channel	Stereo: 2 channels (SP, LP2, LP4)

■ Tuner

Frequency range	FM: 87.5 - 108 MHz AM: 522 - 1,620 kHz
------------------------	---

■ Speaker

Type	2-way type speaker system 5 cm (2") Tweeter 10 cm (4") Woofer
Maximum input power	40 W
Rated input power	20 W
Impedance	4 ohms
Dimensions	Width: 140 mm (5-9/16") Height: 300 mm (11-13/16") Depth: 187 mm (7-3/8")
Weight	1.5 kg (3.3 lbs.)/each



MEMO





MEMO





TERMS OF GUARANTEE

Sharp Electronics (UK) Ltd. ("Sharp") guarantees to provide for the repair, or at its option the replacement, of this product subject to the conditions listed below:-

1. This guarantee shall only apply to faults which are due to inferior workmanship or materials. It does not cover faults or damage caused by accident, misuse, fair wear and tear, neglect, tampering with the product, or repair other than by a Service Facility appointed by Sharp.
2. As this product is intended for private domestic use only, the guarantee will not apply if the product is used in the course of a business, trade or profession.
3. To benefit from this guarantee, any fault which occurs must be notified to Sharp, or its appointed Service Facility within one year from the date this product was purchased. Proof of purchase must be provided.
4. The guarantee does not cover carriage costs, jewelled styli, audio tapes, compact discs or batteries.
5. In the unlikely event of this product requiring repair, please contact the supplier from whom it was purchased. Where this is not possible, please contact the Sharp Customer Information Centre on the telephone number given below.
6. No person has any authority to vary the terms or conditions of this guarantee.
7. This guarantee is offered as an additional benefit to your statutory rights, and does not affect these rights in any way.

If you have any difficulty operating this product, or would like information on other Sharp products, please telephone the Sharp Customer Information Centre on the number given below.

Sharp Customer Information Centre - Telephone 08705 274277

SHARP

SHARP ELECTRONICS (U.K.) LTD.

Sharp House, Thorp Road, Newton Heath, Manchester, M40 5BE

SHARP CORPORATION

TINSE0377AWZZ
A0104. YT

Web-site: www.sharp.co.uk/support **Help Line:** 08705 274277 (office hours)