

KENWOOD

MICRO HI-FI COMPONENT SYSTEM

HM-381MD

INSTRUCTION MANUAL

KENWOOD CORPORATION



2 Before applying power

 **Caution : Read this page carefully to ensure safe operation.**

Units are designed for operation as follows.

Europe and U.K. AC 230V only

*Other countries AC 110-120 / 220-240 V switchable

AC voltage selection

The AC voltage selector switch on the rear panel is set to the voltage that prevails in the area to which the unit is shipped. Before connecting the power cord to your AC outlet, make sure that the setting position of this switch matches your line voltage. If not, it must be set to your voltage in accordance with the following direction.

AC voltage selector switch

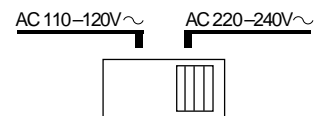





Move switch lever to match your line voltage with a small screwdriver or other pointed tool.

Note:

Our warranty does not cover damage caused by excessive line voltage due to improper setting of the AC voltage selector switch.

Safety precautions

WARNING : TO PREVENT FIRE OR ELECTRIC SHOCK, DO NOT EXPOSE THIS APPLIANCE TO RAIN OR MOISTURE.

	<p>CAUTION RISK OF ELECTRIC SHOCK DO NOT OPEN</p>		<p>CAUTION: TO REDUCE THE RISK OF ELECTRIC SHOCK, DO NOT REMOVE COVER (OR BACK). NO USER-SERVICEABLE PARTS INSIDE, REFER SERVICING TO QUALIFIED SERVICE PERSONNEL.</p>
	<p>THE LIGHTNING FLASH WITH ARROWHEAD SYMBOL, WITHIN AN EQUILATERAL TRIANGLE, IS INTENDED TO ALERT THE USER TO THE PRESENCE OF UNINSULATED "DANGEROUS VOLTAGE" WITHIN THE PRODUCT'S ENCLOSURE THAT MAY BE OF SUFFICIENT MAGNITUDE TO CONSTITUTE A RISK OF ELECTRIC SHOCK TO PERSONS.</p>		
	<p>THE EXCLAMATION POINT WITHIN AN EQUILATERAL TRIANGLE IS INTENDED TO ALERT THE USER TO THE PRESENCE OF IMPORTANT OPERATING AND MAINTENANCE (SERVICING) INSTRUCTIONS IN THE LITERATURE ACCOMPANYING THE APPLIANCE.</p>		

The marking of products using lasers (Except for some areas)

**CLASS 1
LASER PRODUCT**

The marking is located on the rear panel and says that the component uses laser beams that have been classified as Class 1. It means that the unit is utilizing laser beams that are of a weaker class. There is no danger of hazardous radiation outside the unit.

Contents

Preparation section

- ⚠ **Before applying power** 2
- ⚠ **Safety precautions** 2
- ⚠ **IMPORTANT SAFEGUARDS** 4
 - Special features 6
 - In regard to demonstration 6
 - Accessories 7
 - Handling of discs 8
 - Notes on cassette tape 9
 - Digital recording and SCMS 9
- System connection** 10
 - ⚠ **Connection of the System Accessories** 10
 - ⚠ **Connection of Other Accessories (Commercially Available Parts)** 12
- Controls and indicators** 13
 - Display 13
 - Main unit 14
 - Remote control Unit 16
- Operation of remote control unit** 17
 - Channel space setting 17

Basic section

- Let's put out some sound** 18
 - Basic use method 18
 - Playback of CD 20
 - In regard to CD-TEXT 21
 - Playback of Mini Disc 22
 - Playback of tape 26
 - Receiving broadcast station 28
- Let's recording** 30
 - Recording on MD 30
 - Recording on TAPE 32

Application section

- Playback of CD** 34
 - Listening in the desired sequence (program playback) 34
 - Repeated playback 35
 - Listening to an unexpected title sequence (random playback) 36
- Playback of MD** 37
 - Listening in the desired sequence (program playback) 37
 - Repeated playback 38

R.D.S. (Radio Data System)

- (Except for some areas) 39
- Searching for a desired program type (PTY search) 40
- To be able to listen to the desired information at any time 42

Convenient Recording Methods

- Selection of the Recording type 44
- One-touch recording (CD→MD/ CD→TAPE) 45
- Twin recording onto MD and tape (TWIN REC) 46
- Program recording (CD → MD/CD → TAPE) 47
- Program recording (MD→TAPE) 48

MD Edit Functions

- Selecting the editing function type 49
- Assigning a title to a disc or track 50
- Changing or deleting a title 52
- Moving several tracks at a time (QUICK MOVE) 53
- Moving a single track (TRACK MOVE) 55
- Dividing a track (TRACK DIVIDE) 57
- Combining two tracks (TRACK COMBINE) 58
- Erasing a single track (TRACK ERASE) or erasing all tracks on a disc (ALL ERASE) 59

Tone adjustment

- Tone adjustment 61
- Balance adjustment 61
- Adjusting the AUX Input Level 62

Clock adjustment

- 63

Timer operation

- Setting the O.T.T. 64
- Setting the Program Timer 65
- Activating or deactivating the O.T.T. or program timer execution 67
- Sleep timer 67

Knowledge section

- Important Items** 68
 - Maintenance 68
 - Reference 69
- In case of difficulty** 70
- ⚠ **Specifications** 75



Please read all of the safety and operating instructions before operating this appliance. Adhere to all warnings on the appliance and in the instruction manual. Follow all the safety and operating instructions. These safety and operating instructions should be retained for future reference.

- 1. Power sources** – The appliance should be connected to a power supply only of the type described in the instruction manual or as marked on the appliance. If you are not sure of the type of power supply to your home, consult your appliance dealer or local power company. For appliances intended to operate from battery power, or other sources, refer to the instruction manual.
- 2. Power-cord protection** – Power-supply cords should be routed so that they are not likely to be walked on or pinched by items placed upon or against them, pay particular attention to cords at plugs, convenience receptacles, and the point where they exit from the appliance.

Never pull or stretch the cord.

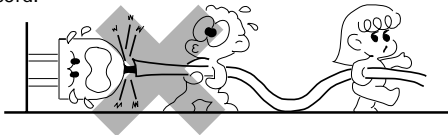

- 3. CAUTION – Polarization** – This appliance may be equipped with a polarized alternating-current line plug (a plug having one blade wider than the other). This plug will fit into the power outlet only one way. This is a safety feature. If you are unable to insert the plug fully into the outlet, try reversing the plug. If the plug should still fail to fit, contact your electrician to replace your obsolete outlet. Do not defeat the safety purpose of the polarized plug.
- 4. Ventilation** – Slots and openings in the cabinet are provided for ventilation and to ensure reliable operation of the appliance and to protect it from overheating, and these openings must not be blocked or covered. The appliance should be situated so that its location or position does not interfere with its proper ventilation.
To maintain good ventilation, do not put records or a tablecloth on the appliance. Place the appliance at least 10 cm away from the walls.
Do not use the appliance on a bed, sofa, rug or similar surface that may block the ventilation openings. This appliance should not be placed in a built-in installation such as a bookcase or rack unless proper ventilation is provided or the manufacturer's instructions have been adhered to.

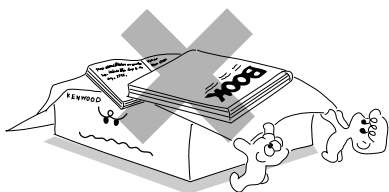

- 5. Water and moisture** – The appliance should not be used near water - for example, near a bathtub, washbowl, kitchen sink, laundry tub, in a wet basement, or near a swimming pool, etc.

- 6. Temperature** – The appliance may not function properly if used at extremely low, or freezing temperatures. The ideal ambient temperature is above +5°C (41°F).
- 7. Heat** – The appliance should be situated away from heat sources such as radiators, heat registers, stoves, or other appliances (including amplifiers) that produce heat.
- 8. Electric shock** – Care should be taken so that objects do not fall and liquid is not spilled into the enclosure through openings. If a metal objects, such as a hair pin or a needle, comes into contact with the inside of this appliance, a dangerous electric shock may result. For families with children, never permit children to put anything, especially metal, inside this appliance.

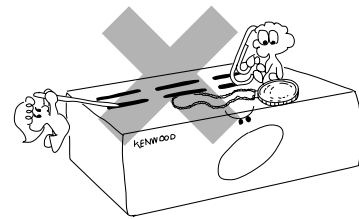

- 9. Enclosure removal** – Never remove the enclosure. If the internal parts are touched accidentally, a serious electric shock might occur.

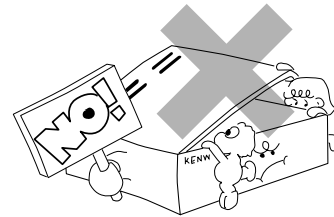

- 10. Magnetic fields** – Keep the appliance away from sources of magnetic fields such as TV sets, speaker systems, radios, motorized toys or magnetized objects.
- 11. Cleaning** – Unplug this appliance from the wall outlet before cleaning. Do not use volatile solvents such as alcohol, paint thinner, gasoline, or benzine, etc. to clean the cabinet. Use a clean dry cloth.
- 12. Accessories** – Do not place this appliance on an unstable cart, stand, tripod, bracket, or table. The appliance may fall, causing serious injury to a child or adult, and serious damage to the appliance. Use only with a cart, stand, tripod, bracket, or table recommended by the manufacturer, or sold with the appliance. Any mounting of the appliance should follow the manufacturer's instructions, and should use a mounting accessory recommended by the manufacturer. An appliance and cart combination should be moved with care. Quick stops, excessive force, and uneven surfaces may cause the appliance and cart combination to overturn.



13. Lightning – For added protection for this appliance during a lightning storm, or when it is left unattended and unused for long periods of time, unplug it from the wall outlet and disconnect the antenna or cable system. This will prevent damage to the appliance due to lightning and power-line surges.

14. Abnormal smell – If an abnormal smell or smoke is detected, immediately turn the power OFF and unplug the appliance from the wall outlet. Contact your dealer or nearest service center.

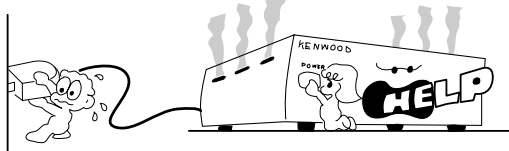

15. Damage requiring service – The appliance should be serviced by qualified service personnel when:

- A.** The power-supply cord or the plug has been damaged.
- B.** Objects have fallen, or liquid has been spilled into the appliance.
- C.** The appliance has been exposed to rain or water.
- D.** The appliance does not appear to operate normally by following the instruction manual. Adjust only those controls that are covered by the instruction manual as an improper adjustment of other controls may result in damage and will often require extensive work by a qualified technician to restore the appliance to its normal operation.
- E.** The appliance has been dropped, or the enclosure damaged.
- F.** The appliance exhibits a marked change in performance.

16. Servicing – The user should not attempt to service the appliance beyond that described in the instruction manual. All other servicing should be referred to qualified service personnel.

17. Outdoor antenna grounding – If an outside antenna is connected to the appliance, be sure the antenna system is grounded so as to provide some protection against voltage surges and built up static charges. Article 810 of the National Electrical Code ANSI/NFPA 70, provides information with respect to proper grounding of the mast and supporting structure, grounding of the lead-in wire to an antenna discharge unit, size of grounding conductors, location of antenna discharge unit, connection to grounding electrodes, and requirements for the grounding electrode. See Figure.

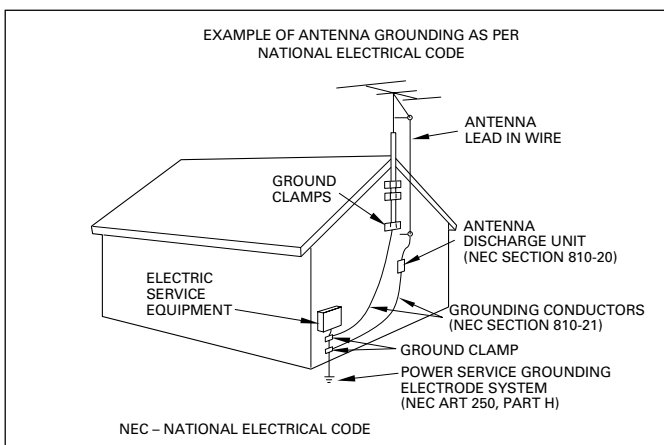

18. Power lines – An outside antenna system should not be located in the vicinity of overhead power lines or other electric light or power circuits, or where it can fall into such power lines or circuits. When installing an outside antenna system, extreme care should be taken to keep from touching such power lines or circuits as contact with them might be fatal.

19. AC outlets – Do not connect other audio equipment with a power consumption larger than that specified to the AC outlet on the rear panel. Never connect other electrical appliances, such as an iron or toaster, to it to prevent fire or electric shock.

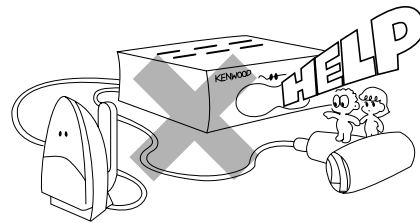

20. Overloading – Do not overload wall outlets, extension cords, or integral convenience receptacles as this can result in a risk of fire or electric shock.

21. Attachment – Do not use attachments not recommended by the appliance manufacturer as they may cause hazards.

22. Replacement parts – When replacement parts are required, be sure the service technician has used replacement parts specified by the manufacturer or have the same characteristics as the original parts. Unauthorized substitutions may result in fire, electric shock, or other hazards.

23. Safety check – Upon completion of any service or repairs to this appliance, ask the service technician to perform safety checks to determine that the appliance is in proper operating condition.

Notes:

1. Item 3 is not required except for grounded or polarized equipment.
2. Item 17 and 18 are not required except for units provided with antenna terminals.
3. Item 17 complies with UL in the U.S.A.

Special features

An MD recorder is standard equipment

An MD recorder with high digital sound quality is standard equipment. Digital copying from a CD is also easy. This recorder has many functions like recording and display of names for discs and titles, changing the sequence of tracks, etc.

CD player and auto-reverse cassette deck as standard equipment

A CD player and auto-reverse cassette deck are also provided in addition the MD recorder, making the unit an integrated micro stereo system for enjoyment of multiple music sources.

Convenient Recording Methods

Various versatile recording functions are provided according to the use purposes.

- One-touch recording : Recording of one CD or one track by pressing a single key
- TWIN REC function : Simultaneous recording from CD to MD and tape.
- Program recording : Any desired tracks can be recorded in the desired sequence

Convenient timer functions

Two-program timer : Timer playback, timer recording and AI timer playback can be programmed.

- AI timer : When the unit is turned ON by the timer, the sound level increases gradually.

O.T.T. : Timer with easy setting, which operates only once.

Sleep timer : Useful when you want to go asleep while listening to music.

In regard to demonstration

This unit is equipped with a demonstration function (only display). The demonstration consists of sequential change of display and indicators showing the operations, but the audio itself does not change. The demonstration function can be cancelled as follows.



DEMO OFF (To cancel demonstration):

Press the "set/demo" key when DEMO is ON.

DEMO ON (To execute demonstration):

After turning power ON, press and hold the "set/demo" key (for more than 2 seconds).

- Even when DEMO is ON, stations with weak radio waves are muted and their sound cannot be heard.
- This operates automatically when a power failure has occurred or the plug of the power cable has been pulled while the power was ON. Cancellation is possible by pressing the key during the demonstration.

Unpacking

Unpack the unit carefully and make sure that all accessories are put aside so they will not be lost.

Examine the unit for any possibility of shipping damage. If your unit is damaged or fails to operate, notify your dealer immediately.

If your unit was shipped to you directly, notify the shipping company without delay. Only the consignee (the person or company receiving the unit) can file a claim against the carrier for shipping damage.

We recommend that you retain the original carton and packing materials for use should you transport or ship the unit in the future.

Accessories

Please confirm that the following accessories are present.

FM indoor antenna (1)

Europe, and U.K.

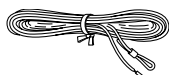

Other countries

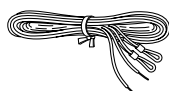

Loop antenna (1)

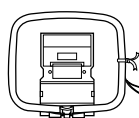

Remote control unit (1)

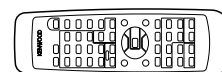

Batteries (R6/AA) (2)

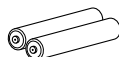

*AC plug adaptor (1)

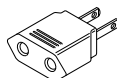

* Use to adapt the plug on the power cord to the shape of the wall outlet.
(Accessory only for regions where use is necessary.)

Handling of discs

Disc handling precautions

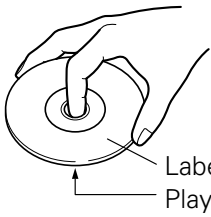

Handling

Hold the discs so that you do not touch the playing surface.

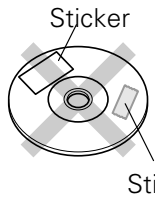

Sticky paste

Do not attach paper or tape to either the playing side or the label side of the discs.

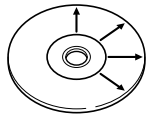

Cleaning

If fingerprints or foreign matter become attached to the disc, lightly wipe the disc with a soft cotton cloth (or similar) from the center of the disc outwards in a radial manner.

Storage

When a disc is not to be played for a long period of time, remove it from the player and store it in its case.

Discs which can be played with this unit

CD (12 cm, 8 cm), and the audio part of CDV, CD-G, CD-EG and CD-EXTRA.

Use discs that comply with the IEC standard, for example a disc carrying the  marking on the label surface.

Never play a cracked or warped disc

During playback, the disc rotates at high speed in the player. Therefore, to avoid danger, never use a cracked or deformed disc or a disc repaired with tape or adhesive agent. Please do not use discs which are not round because they may cause a malfunction.

Disc accessories

The disc accessories (stabilizer, protection sheet, protection ring, etc.) which are marketed for improving the sound quality or protecting discs as well as the disc cleaner should not be used with this system because they may cause malfunction.

Handling of Mini Disc

As the Mini Disc is accommodated inside a cartridge, it can be handled without caring about dust or fingerprint. However, stained or soiled cartridge may cause malfunction. To enjoy beautiful sound for extended period of time, take care on the following points.

Do not touch the disc directly.

Do not touch the disc by opening the shutter with your hand. The cartridge will be damaged if it is forced open.

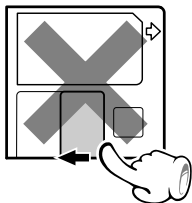

Storage position

Do not leave Mini Discs in place where the temperature and/or humidity are extremely high (for example, in a place subject to direct sunlight).

Dust countermeasure

The shutter of the disc cartridge is permanently open while the disc is loaded in the set. Therefore, to prevent dust from penetrating inside the disc, take the disc out of the unit immediately after completion of recording or playback.

Care

Wipe periodically dust and dirt attached on the cartridge with a dry cloth.

Write protect tab

To protect recorded contents against accidental erasure, set the write protect tab of the disc open. Return the tab to the original position when you want to record signals on the disc.

Disc back side

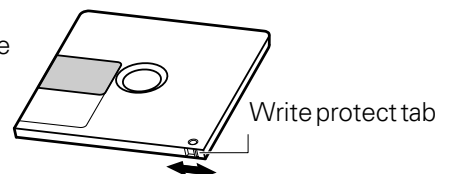

Slide open.

(Recording disabled)

Slide close.

(Recording enabled)

- If the write protect tab is opened, "PROTECTED" appears on the dot display.

Notes on cassette tape

Safety tab (accidental erasure prevention tab)

After an important recording has been finished, break the safety tab, to prevent the recorded contents from being erased or recorded on accidentally.

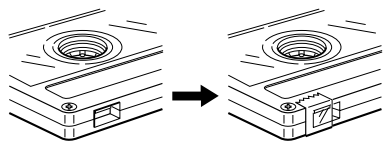
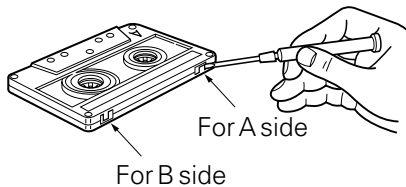

To re-record

Apply tape only to the position where the tab has been removed.

To store cassette tapes

Do not store the tapes in a place which is subject to direct sunlight, or near equipment that generates heat. Keep the cassette tapes away from any magnetic field.

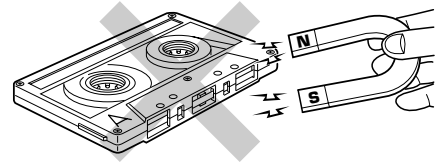

When there is slack in the tape

In such a case, insert a pencil into the reel hole and wind the reel hub to remove the slack.

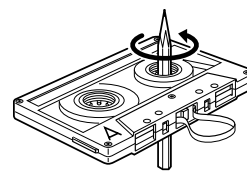

1. Longer tape than 110 minutes cassette tape

Since longer tape than 110 minutes cassette tape is very thin, the tape could adhere to the pinch roller or be easily broken. It is recommended that these tapes not be used with this unit to prevent possible damage.

2. Endless tapes

Do not use an endless tape, as this could damage the mechanism of the unit.

Digital recording and SCMS

Designed for copyright protection, the SCMS is a prescription that copying of digital signals as they are in the digital form between digital audio equipment is allowable only for one generation. Digital recording is not available with commercially marketed music software (CD, MD, etc.) containing the copy prohibit code.

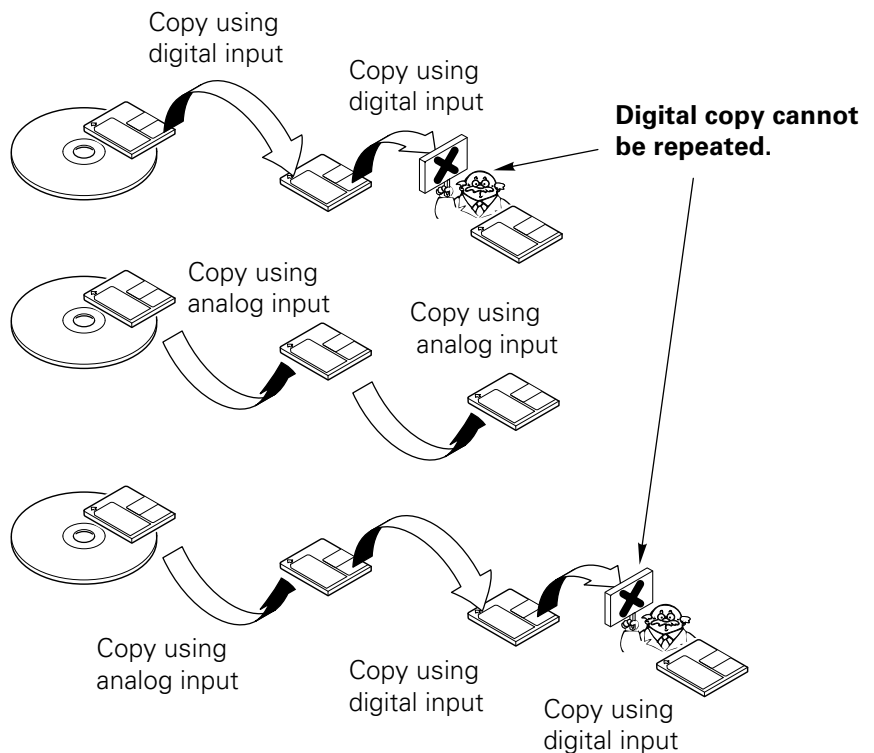

Connection of the System Accessories

This figure shows the method of connection between the main unit and provided accessories.

CAUTION Note on Connection

Connect the components as shown in the diagram.

Only plug the power cord into a power outlet once connections are completed.

Malfunction of microcomputer

If operation is not possible or erroneous display appears even though all connections have been made properly, reset the microcomputer referring to "In case of difficulty". → 70

AM loop antenna

The supplied antenna is for indoor use. Place it as far as possible from the main system, TV set, speaker cords and power cord, and set it to a direction which provides the best reception.

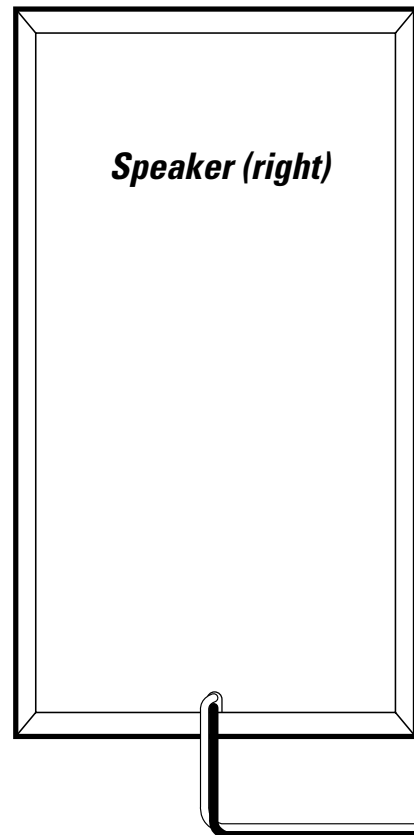
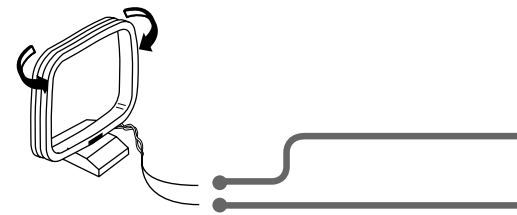
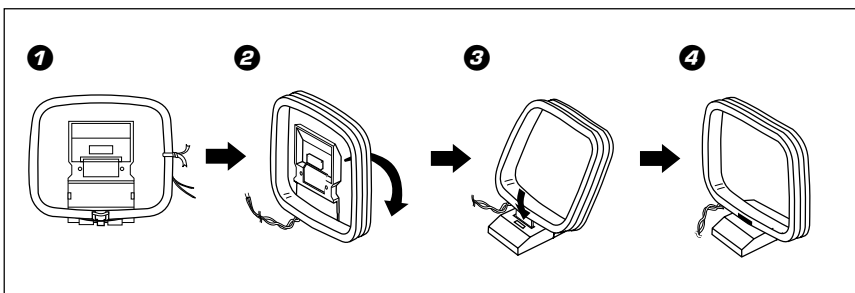

1. Never short-circuit the "+" and "-" speaker cords.
2. If the left and right speaker connections or the "+" and "-" polarity are inverted, the sound will be unnatural with unclear positioning of musical instruments, etc. Be sure to connect them without mistake.
3. Be sure to insert all connection cords securely. If their connections are imperfect, the sound may not be produced or noise may interfere.
4. Before plugging or unplugging a connection cord, be sure to unplug the power cord from the wall AC outlet. If connection cords are plugged or unplugged with the power cord left plugged in, malfunction or damage may result.

Main Unit

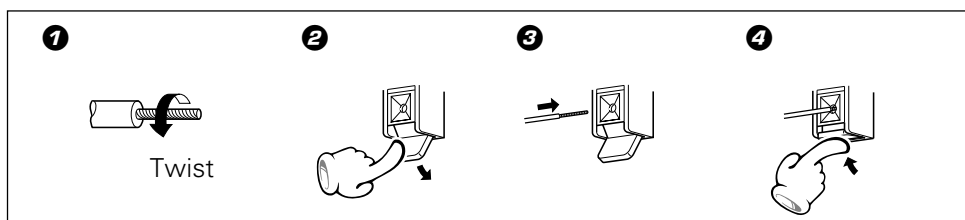

FM indoor antenna

The accessory antenna is for temporary indoor use only. For stable signal reception we recommend using an outdoor antenna. Remove the indoor antenna if you connect one outdoors.

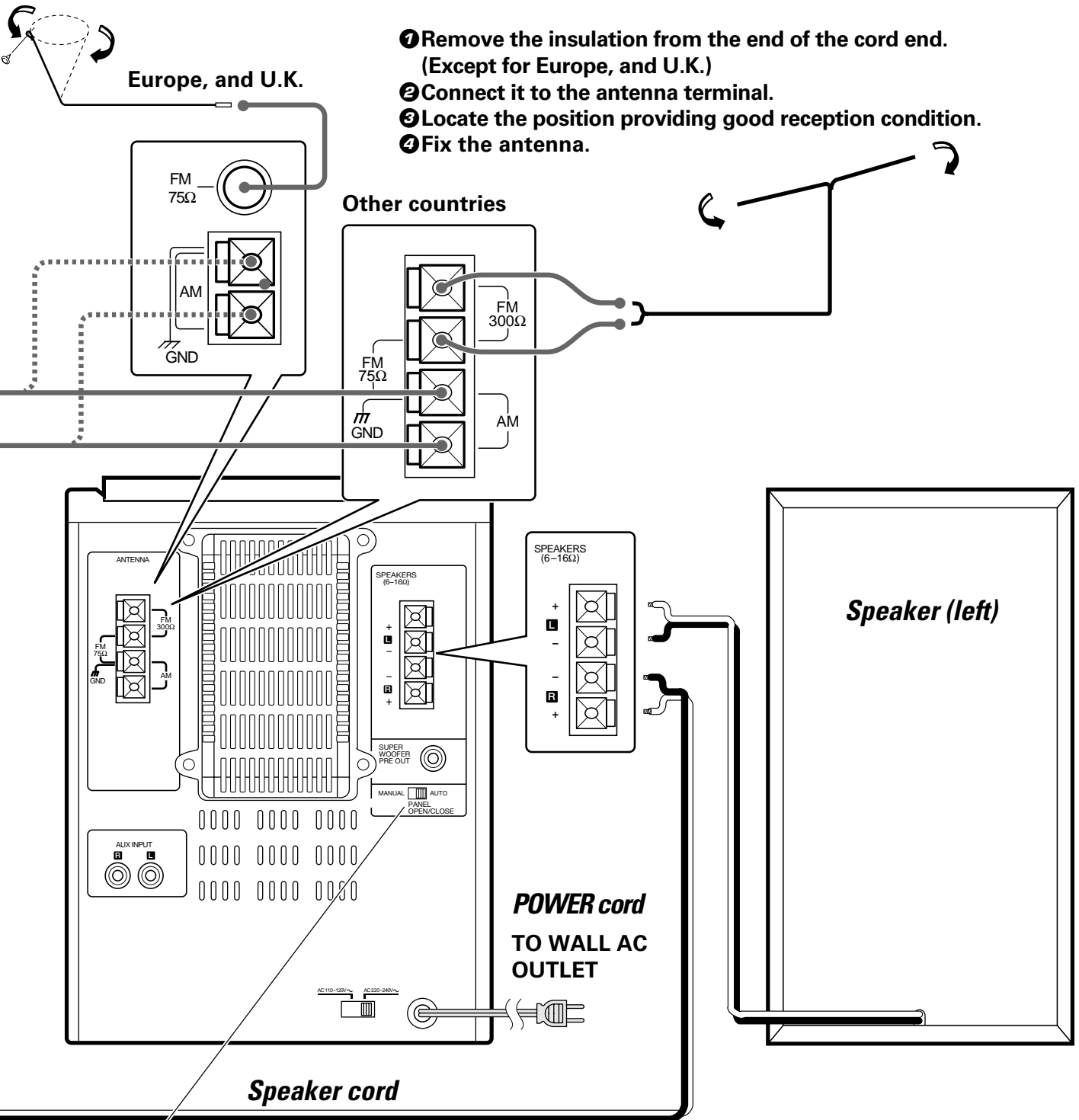

Connect correctly + to + and - to -.

PANEL OPEN/CLOSE switch
Change the operation mode of the "REVOLVING CONTROL PANEL".

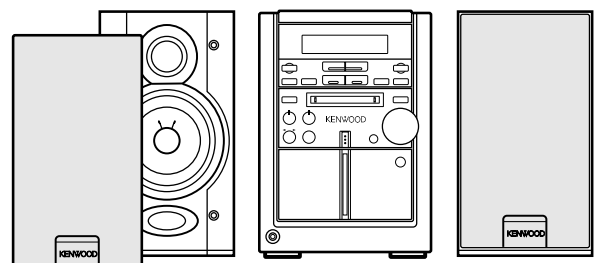

Connection of Other Accessories (Commercially Available Parts)

CAUTION Note on Connection
 Connect the components as shown in the diagram.
 Only plug the power cord into a power outlet once connections are completed.

Preparation section

FM outdoor antenna

Lead the 75Ω coaxial cable connected to the FM outdoor antenna into the room and connect it to the FM 75Ω terminal. Please remove the indoor antenna after an outdoor antenna has been installed.

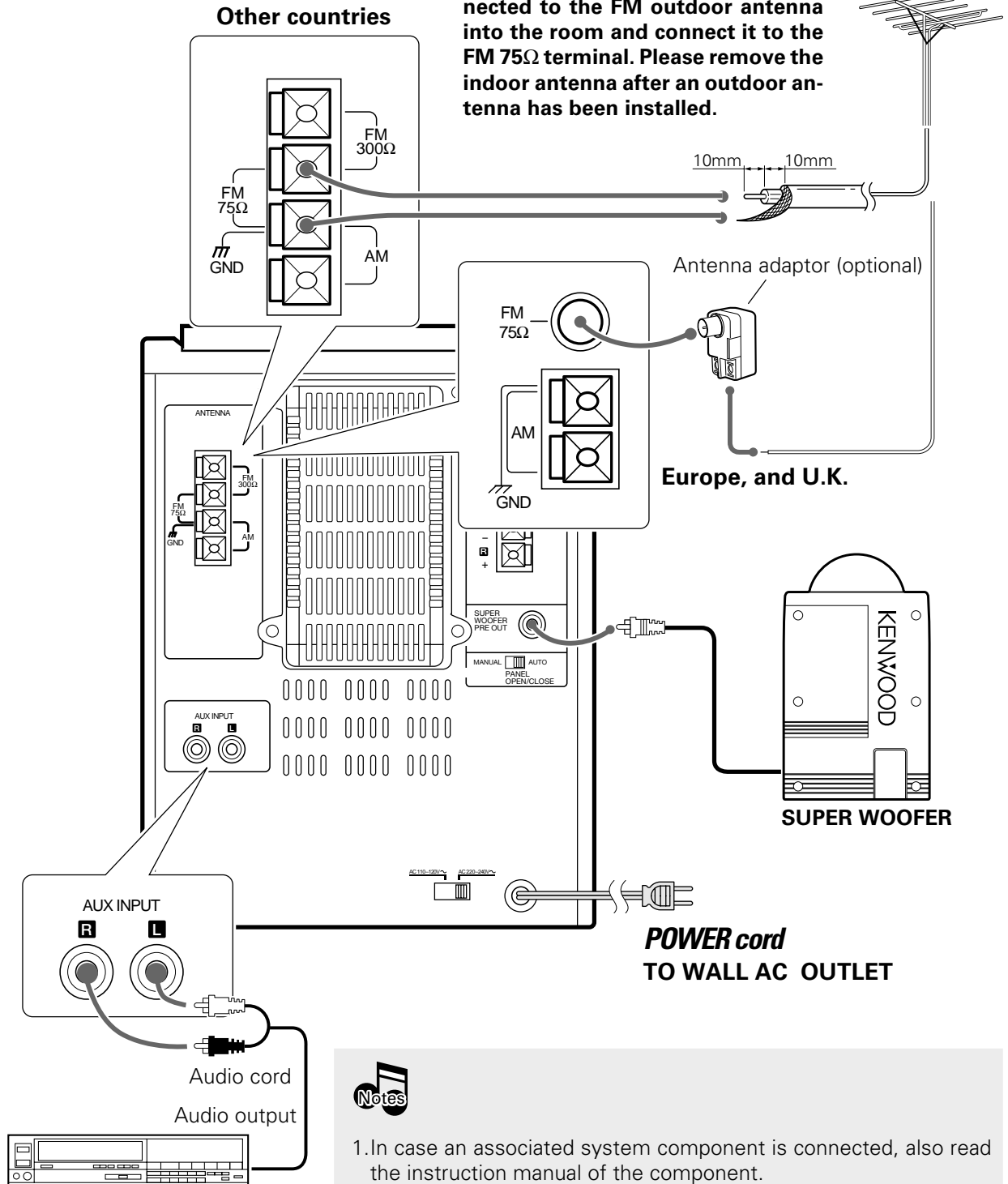

[VCR, Analog turntable with built-in RIAA equalizer (optional P-110), etc.]



1. In case an associated system component is connected, also read the instruction manual of the component.
2. Insert the optical-fiber cable straight into the connector until it clicks.
3. Be sure to attach the protection cap when the connector is not used.
4. Never band or bundle the optical-fiber cable.

Display

(The displays given in this manual are approximations only. They may differ from what actually appears on the display.)

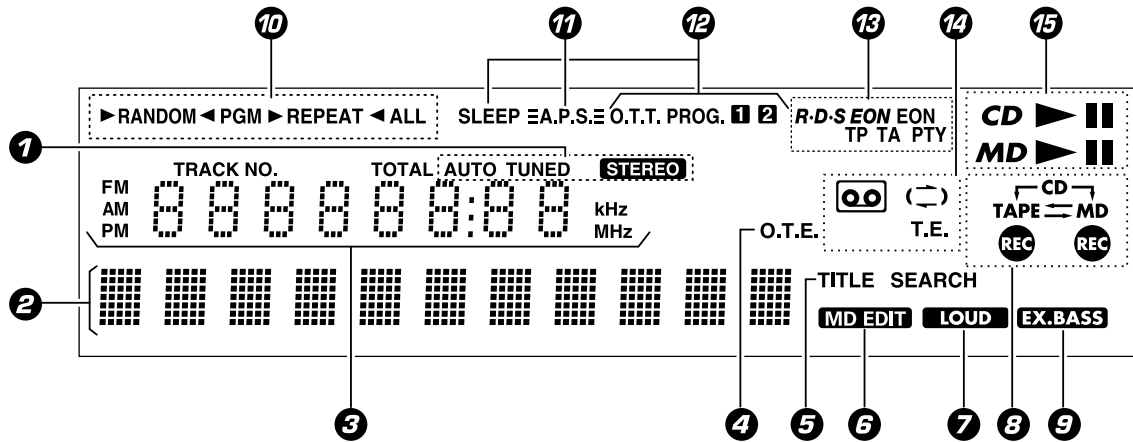

1 Tuner-related indicators

2 Character information display section (dot display)

Shows character information including the input selection, volume level and disc/track title.

3 Character information display section

Frequency indication, time indication, track No., program No., etc.

4 O.T.E. (ONE TOUCH EDIT) indication

Appears during one-touch recording.

5 TITLE SEARCH indication

6 MD EDIT indication

7 LOUD (Loudness) indication

8 TAPE REC and MD REC indicators

9 EX.BASS (extra bass) indication

10 Indication related to CD/MD

11 Auto Power Save indicator

12 Timer-related indicators

13 RDS-related indication (except for some areas)

14 Cassette deck, reverse mode and TAPE equalizer (T.E.) indicators

15 CD/MD play/pause indicators

Indicates the play and pause modes of CD and MD.

Main unit

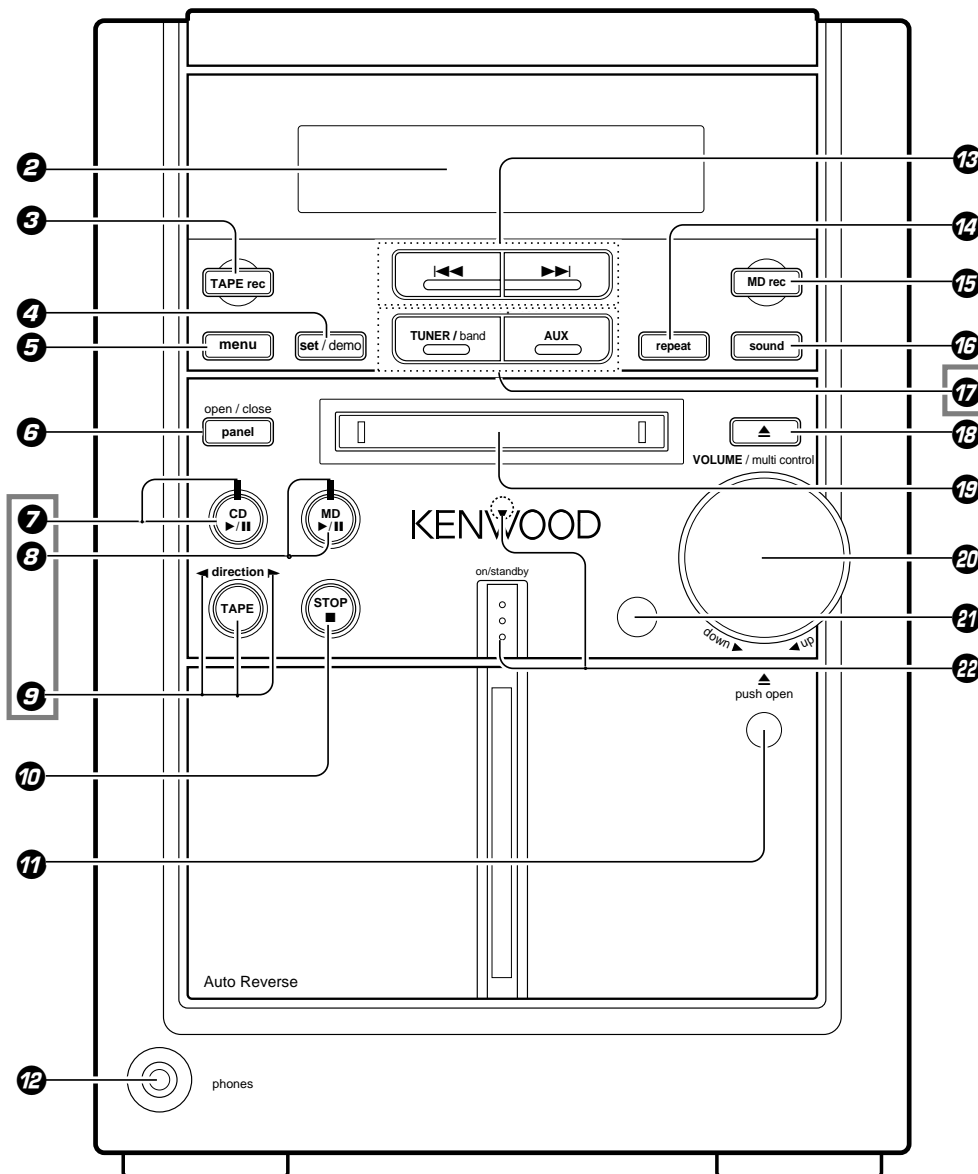
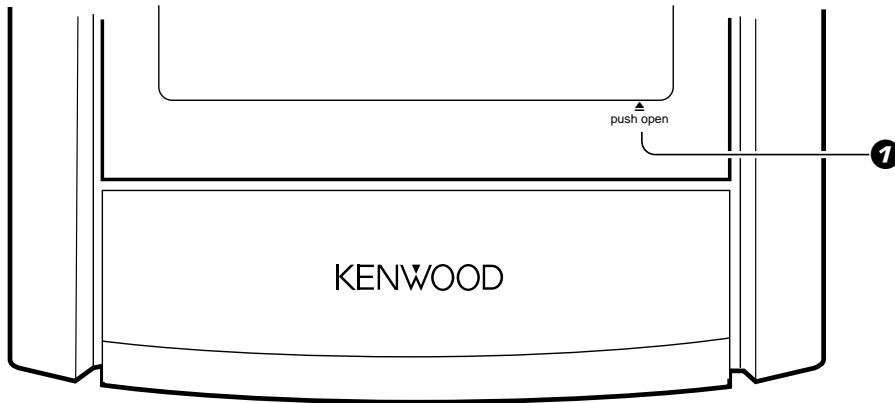

About the one-touch operation function

This unit incorporates the one-touch operation function for the user's convenience. With this function, pressing any key enclosed in while the unit is in standby mode immediately start playback (or reception).

- ① **CD cover open (▲)**
Press to open the CD player cover.
- ② **Display**
- ③ **Tape record key (TAPE rec)** → 33
Press to start recording. Pressing the key during recording stops it after leaving a non-recorded space (blank) of about 4 seconds.
- ④ **"set/demo" key**
Press to set or enter an item selected with the "VOLUME/multi control".
Used for demonstration ON/OFF.
- ⑤ **"menu" key** → 15
Press to switch the function of the "VOLUME/multi control (up/down)" knob.
This key is also used when setting the time of the day.
- ⑥ **"panel open / close" key**
- ⑦ **CD play/pause key (CD ►/||)** → 20
Press to select the CD input and start CD playback.
Press during CD playback to let it pause temporarily.
- ⑧ **MD play/pause key (MD ►/||)** → 22
Press to select the MD input and start MD playback.
Press during MD playback to let it pause temporarily.
Press during MD recording to let it pause temporarily.
- ⑨ **Tape play key (TAPE)/ TAPE direction indicator** → 26
- ⑩ **Stop key (■)**
- ⑪ **Cassette holder**
Press the area marked "▲ push open" to load or eject a tape.
- ⑫ **"phones" jack**
Headphones with a stereo mini plug (optional) can be connected.
- ⑬ **Skip/search keys (◀◀, ▶▶/◀◀, ▶▶)**
During CD or MD operation : → 21 → 23

- Press to skip tracks in the forward or backward direction.
- During TAPE operation :** → 27
Press to search in the forward or backward direction.
- During TUNER operation :** → 28
Press to receive a preset station.
These keys are also used during MD editing, track number selection and title character selection.
- ⑭ **"repeat" key** → 35 → 38
Used for repeated playback of CD or MD.
- ⑮ **MD record key (MD rec)** → 31
Press to start MD recording.
- ⑯ **"sound" key** → 19
Used for switching the EX.BASS play and LOUDNESS play.
- ⑰ **"TUNER/band" key** → 28
The received broadcasting band is switched.
Press to select the TUNER input.
- AUX input key**
Press to listen to the input source connected to AUX (analog external).
- ⑱ **MD eject key(▲)**
This key is pressed to remove disc.
- ⑲ **Mini Disc insertion slot**
- * ⑳ **"VOLUME/multi control (up/down)" knob** → 15
Normally this is used for volume adjustment.
- ㉑ **Remote sensor**
- ㉒ **"on/standby" key**
The system is switched ON and STANDBY.
- Standby / timer indicator**
Light in standby mode of power.
Red :Normal standby mode
Orange :O.T.T. standby
:Program timer standby
Green :Power ON mode

*** About the VOLUME/multi control (up/down) knob**

After selecting the function of this knob with the "menu" key, select the desired control item by turning the "VOLUME/multi control (up/down)" knob. To set or enter the setting of the selected item, press the "set/demo" key.

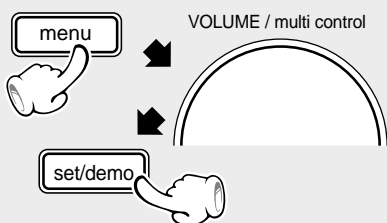

Turning the knob switches the function as shown in the character information display.

- ▶ **TAPE RVS.** ? → 27
- ▶ **O.T.E.** ? → 45
- ▶ **A. MEMORY (or A. PRESET) ?** → 29
(Only when the TUNER input is selected)
- ▶ **AUX LEVEL** ? → 62
(Only when the AUX input is selected)
- ▶ **BALANCE** ? → 61
- ▶ **TIMER SET** ? → 64
- ▶ **A.P.S. SET** ? → 19

- The function of the control knob returns to the normal mode when it has not been operated for 5 seconds.

About the REVOLVING CONTROL PANEL

AUTO

- The REVOLVING CONTROL PANEL is closed when the power supply is in STANDBY mode.
- When the power is switched ON, the REVOLVING CONTROL PANEL opens.
- When the power is ON, the panel opens and closes alternately each time the "panel open / close" key is pressed.

MANUAL

- When the power is ON, the panel opens and closes alternately each time the "panel open / close" key is pressed.

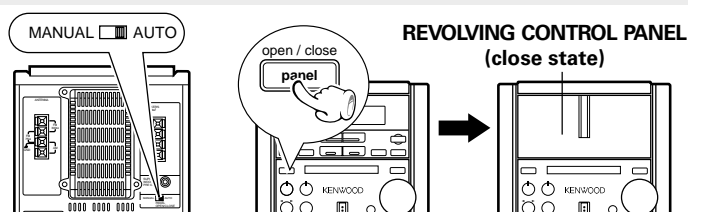

Remote control unit

The keys on the remote control unit with the same names as on the main unit have the same function as the keys on the main unit.

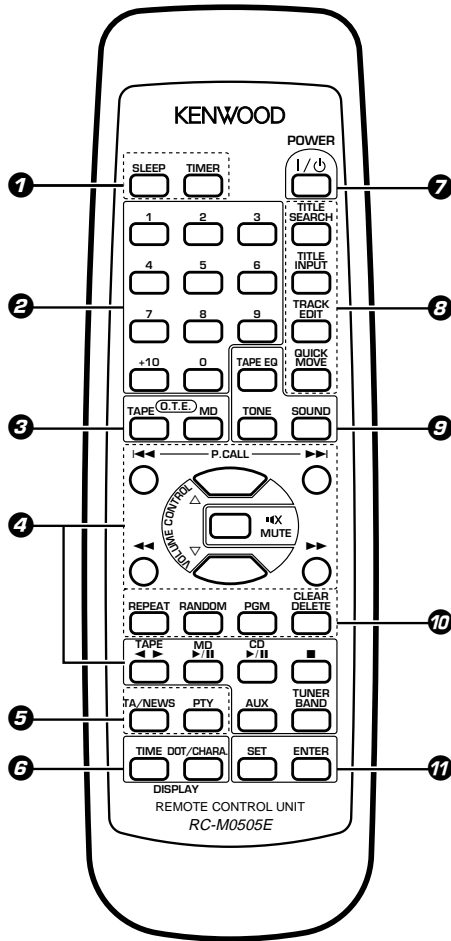

Infrared ray system

Model : RC-M0505E (For Europe and U.K.)
: RC-M0503 (For other countries)

- 1 SLEEP key** → 67
This is used to set the sleep timer.
- TIMER key** → 67
Used to select the timer.
- 2 Numeric keys**
These are used to select CD or MD tracks and as preset call keys for the tuner.
- 3 TAPE O.T.E. key/ MD O.T.E. key** → 45
These keys are used for recording of a CD onto tape or MD with a one-touch operation.
Press either key during CD playback to record the currently played track onto tape or MD. Press in stop mode to record the entire CD onto tape or MD.
- 4 Basic operation keys**
P.CALL/skip keys (◀◀, ▶▶) → 21 → 23 → 50
During CD or MD operation :
Press to skip tracks in the forward or backward direction.
These keys are used in MD editing, input character selection.
During TUNER operation: → 28
Press to receive a preset station.
Fast forward, fast reverse keys (◀◀, ▶▶)
During CD,MD or TAPE operation: → 21 → 23 → 27 → 52
Press to search in the forward or backward direction.
Use these to move the cursor when inputting MD titles.
During TUNER operation: → 28
Press to select a radio station.

- VOLUME CONTROL (Δ,▽) keys**
MUTE key → 18
This is used to suppress the sound temporarily.
- TAPE ◀ ▶ key**
MD ▶/|| key
CD ▶/|| key
Stop key (■)
AUX key
TUNER BAND key
- 5 RDS-related keys (Only some areas)**
TA/NEWS key → 42
Used at the time of EON reservation.
PTY key → 40
Used at the time of program type detection.
- 6 TIME key**
Press to switch the time information displayed during CD or MD playback.
DOT/CHARA. key → 25
This key switches the display mode of the dot display.
- 7 POWER (I/⏻) key** → 18 → 67
The system is switched ON and STANDBY.
This key is also used to activate or cancel the timer program execution.
- 8 TITLE SEARCH key** → 24
This is used in searching an MD title.
TITLE INPUT key → 50
This is used in MD title input operation.
TRACK EDIT key → 55 → 57 → 58
This is used in MD editing for reordering tracks, deleting tracks, etc.
QUICK MOVE key → 53
This is used in reordering of MD tracks.
- 9 SOUND key** → 19
Used for switching the EX.BASS play and LOUDNESS play.
TONE key → 61
This is used to adjust the tone.
TAPE EQ. key → 27
- 10 Keys related to CD and MD**
(Common keys for CD and MD function for CD or MD according to the input selection.)
REPEAT key (CD, MD) → 35 → 38
This is used for repeated playback.
RANDOM key (CD) → 36
Playback of the CD tracks in random order.
PGM key (CD, MD) → 34 → 37
This is used to program the track sequence.
During TUNER operation: → 29
Used to switch the tuning mode between "AUTO" (auto tuning, stereo reception) and Manual (manual tuning, monaural reception).
CLEAR DELETE key (CD, MD) → 34 → 37 → 52
The programmed track sequence is cleared.
- 11 SET key** → 50
This is used to set an MD editing operation or to set or enter the item selected with the "VOLUME/multi control" knob.
ENTER key → 51
This is used to execute an MD editing operation or to enter an input title. It is also used to enter the preset station memory in the tuner.

Loading batteries

❶ Remove the cover.

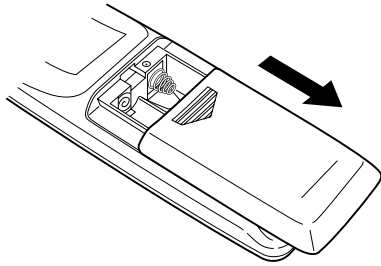

❷ Insert batteries.

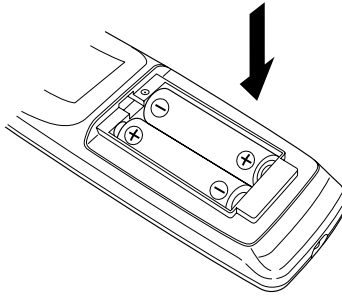

❸ Close the cover.

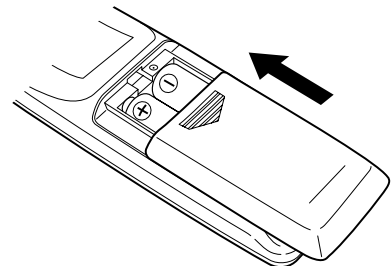

- Insert two R6 ("AA"-size) batteries following the polarity indications.

Operation

After plugging the power cord of this unit, press the **POWER (I/⏻)** key of the remote control unit to turn the system ON. When the system is turned ON, press the key of the function to be operated.

- When pressing more than one remote control keys successively, press the keys securely by leaving an interval of 1 second or more between keys.

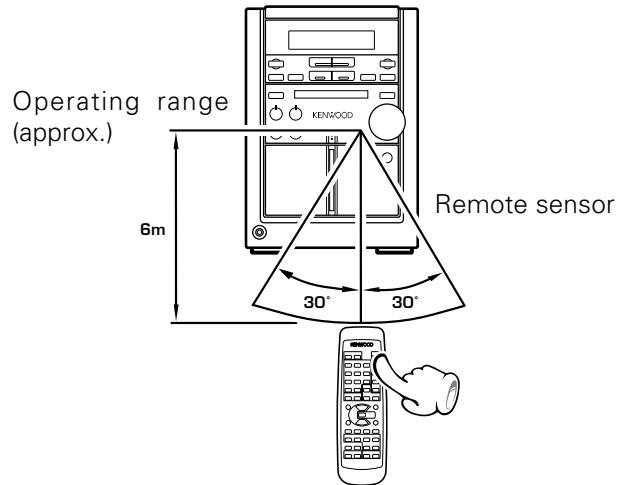

1. The provided batteries are intended for use in operation checking, and their service life may be short.
2. When the remote controllable distance becomes short, replace both of the batteries with new ones.
3. If direct sunlight or the light of a high-frequency fluorescent lamp (inverter type, etc.) is incident to the remote sensor, malfunction may occur. In such a case, change the installation position to avoid malfunction.

Channel space switching

(Except for the United Kingdom and Australia)

The space between radio channels has been set to the one that prevails in the area to which the system is shipped. However, if the current channel space setting does not match the setting in the area where the system is to be used, for instance when you move from area 1 or area 2 shown in the following table or vice versa, proper reception of AM/FM broadcasts cannot be expected. In this case, change the channel space setting in accordance with your area by referring to the following table.

Area		CHANNEL Space Frequency
1	USA, Canada and South American countries	FM: 100 kHz AM: 10 kHz
2	Other countries	FM: 50 kHz AM: 9 kHz

❶ Turn power on.

❷ Press the **TUNER/band** key

❸ Select the mode by using the "repeat" key.

Each press switches the space frequency alternately.

- ❶ "FM 50 kHz" (FM 50 kHz, AM 9 kHz)
- ❷ "FM 100 kHz" (FM 100 kHz, AM 10 kHz)

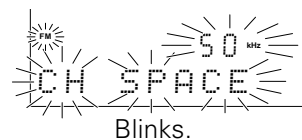

❹ Establish the selection by pressing the "set/demo" key.

Basic use method

Bass and treble compensation

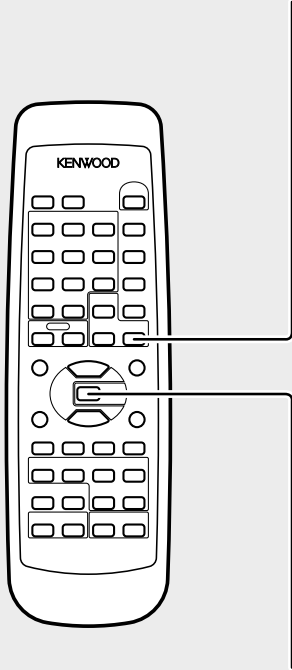

Muting the sound temporarily

Bass and treble compensation

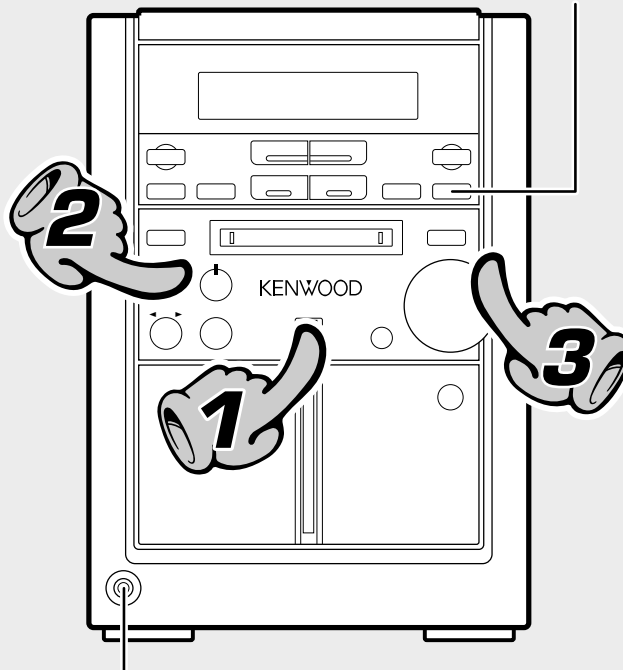

Listening through headphones

Basic section

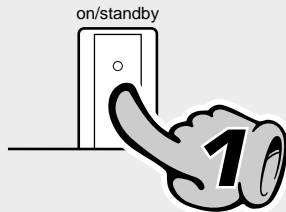

1. Set the "on/standby" key to ON (STANDBY).

When the "on/standby" key (I / ⏻) is pressed while the unit is ON, the unit is switched off.

- Pressing the **CD ▶/II**, **MD ▶/II**, **AUX**, **TAPE** or "TUNER band" key also turns power on and starts playback (reception) of the corresponding input. (One-touch operation)
- When the **CD**, **MD** or **TAPE** input is selected while the corresponding disc or tape has been loaded, it immediately starts to play.

Example:
To select the CD input

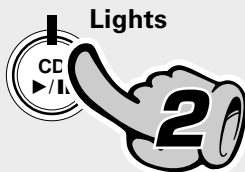

2. Selecting the desired output.

TUNER (Broadcasts)	→ 28
CD	→ 20
MD	→ 22
TAPE	→ 26
AUX (External input)	→ 12

- Pressing the **CD ▶/II**, **MD ▶/II**, **AUX**, **TAPE** or "TUNER band" key selects the corresponding input.

VOLUME / multi control

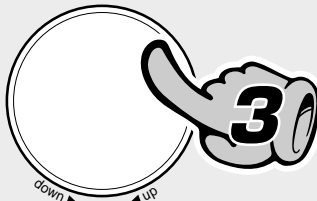

The volume decreases

The volume increases

3. Volume adjustment.

- Quick turning produces a larger change amount. (Dynamic rotary volume control function)
- The display shows a reference value. (The reference value is also indicated by the CLOCK display)

Listening through headphones

Insert the headphone plug into the "phones" jack.

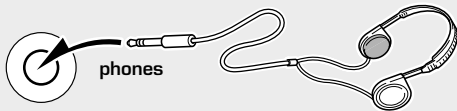

- Headphones with a stereo mini plug can be connected.
- The sounds from all speakers are cut off.

Muting the sound temporarily (Remote control unit only)



- Press again to resume the original volume.
- This is also cancelled when the volume is changed.

Standby mode

When the standby/timer indicator on the main unit lights in red or orange, a minute current flows for memory protection. This condition is called standby mode.

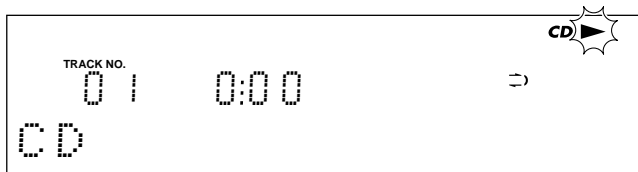

When CD has been selected.

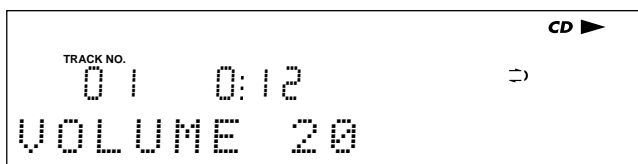

Volume display

Bass and treble compensation



Each press switches the modes as follows.

- ① "EX.BASS" (Extra Bass) lights. The lowest and highest frequencies are enhanced regardless of the current volume level.
- ② "LOUD" (Loudness) lights. The lowest and highest frequencies are enhanced according to the current volume level. (Effective during low-volume listening.)
- ③ Both indicators off. Sound enhancement mode is disengaged.

- Adjusting the tone while the "LOUD" or "EX.BASS" indicator is lit turns it off and cancels the sound enhancement mode.



AUTO POWER SAVE function

When the unit is ON and the unit is left for 30 minutes with CD, MD and TAPE not operating, the unit is switched off automatically by this function. This is convenient when you forgot to switch off the unit. This function can be activated or deactivated by the following operation.

- ① Select "A.P.S. SET?".

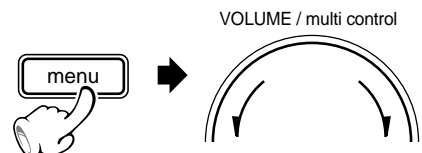

(Press the "set/demo" key while the "?" mark is blinking.)

- ② Select.

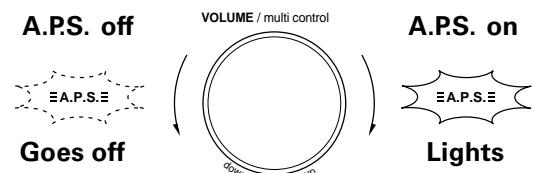

- ③ Set it.

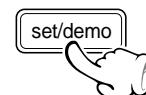

- When the TUNER or AUX input is selected, APS operates only when the volume is set to zero or when MUTE is on.

Playback of CD



When a disc is placed into the CD player in advance, the unit will be switched on automatically by pressing the CD ►/II key, and playback will start.

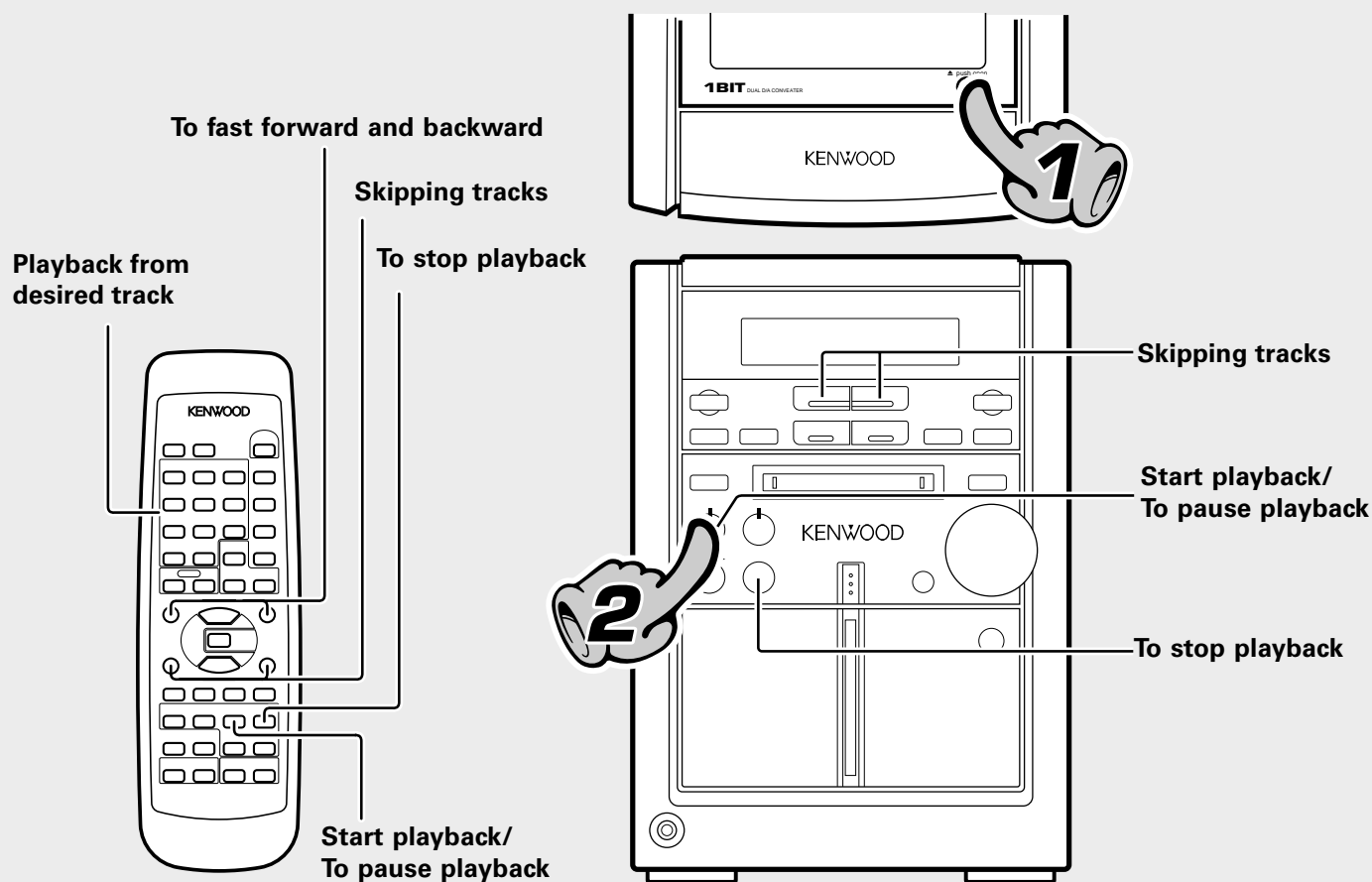

Open the CD cover.

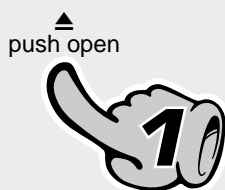

1. Load a disc.

- ① Open the CD cover.
- ② Place a disc.
- ③ Close the CD cover.

The label side must be on top.

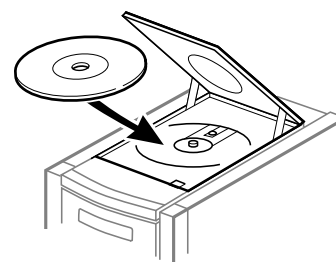

2. Start playback.



Skipping tracks

To skip backward

To skip forward

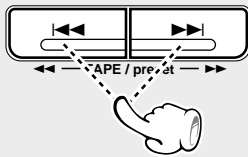

- The track in the direction of the key pressed is skipped, and the selected track will be played from the beginning.
- When the I◀◀ key is pressed once during playback, the track being played will be played from the beginning.
- Operation also is possible with the keys I◀◀ and ▶▶I of the remote control unit.

To fast forward and backward (Remote control unit only)

Backward search

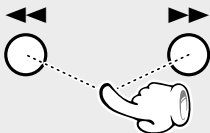

Forward search

- Playback starts from the position where the key is released.

Playback from desired track

Select the desired track No.

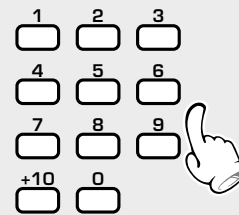

Press the numeric keys as shown below....

To select track No. 23 : [+10] [+10] [3]

To select track No. 40 : [+10] [+10] [+10] [+10] [0]

To pause playback



- Each press pauses and plays the CD alternately.

To stop playback



- Do not touch the played side of disc.
- Be sure to place a disc horizontally. Placing it with an inclination will result in malfunction.

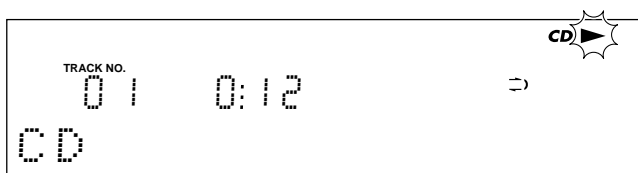

- Titles are displayed for discs conforming to CD-TEXT.
- After a few seconds, play starts from track No.1.

In regard to CD-TEXT

When discs conforming to CD-TEXT are played with this unit, the text information recorded on the CD (disc name or titles) is displayed automatically.

Time display on CD player

(Remote control unit only)

Each press of the TIME key changes the displayed contents.

- ① 1:23 (Elapsed time of track being played)
- ② - 2:37 (Remaining time of track being played)
- TOTAL
- ③ 23:45 (Elapsed time of entire disc)
- TOTAL
- ④ - 36:15 (Remaining time on entire disc)

- Only time information ① and ② can be displayed during single-track repeated playback or random playback.

Playback of Mini Disc



When a disc is placed into the MD recorder in advance, the unit will be switched on automatically by pressing the MD ▶/II key, and playback will start.

Start playback/To pause playback

Playback from desired track

Skipping tracks

To fast forward and backward

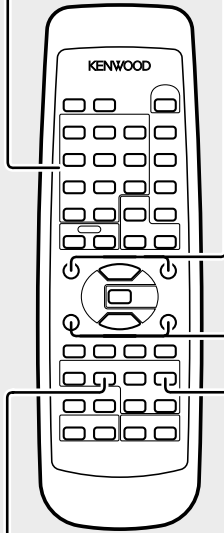

Start playback/
To pause playback

To stop playback

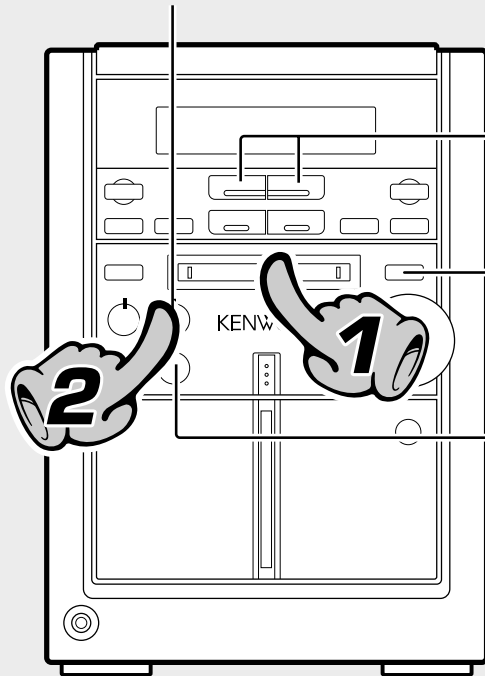

Skipping tracks

Ejecting the disc

To stop playback

Basic section

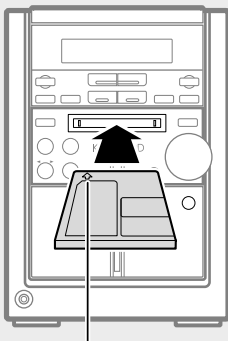

In the direction of the arrow

1. Load a Mini Disc.

Insert the minidisc correctly into the slot of this unit.

- When a title has been recorded for the disc, the title is displayed.

CAUTION

The MD cannot be loaded or ejected while the unit is in standby mode. Do not force load a MD in standby mode, otherwise malfunction will result.

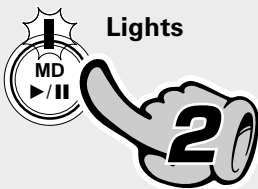

2. Start playback.

To listen from the track No. 1

- In a few seconds, playback starts from track No. 1.
- If the MD being played contains recording of track titles, the track title is displayed at the beginning of each track during playback.

To select a track

Press the numeric keys as shown below....

To select track No. 23:

..... **+10** **+10** **3**

To select track No. 40:

..... **+10** **+10** **+10** **+10** **0**

- If the "PGM" indicator is lit, stop the MD recorder and press the **PGM** key of the remote control unit to turn the indicator off.
- If a track NO. which does not exist on the disc is selected while "READING" is blinking, the last track on the disc will be played.

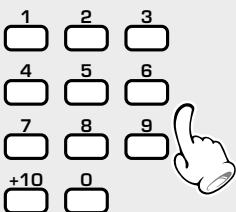

Skipping tracks

To skip backward

To skip forward

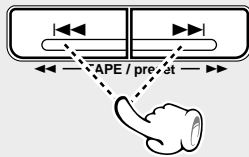

- The track in the direction of the key pressed is skipped, and the selected track will be played from the beginning.
- When the I◀◀ key is pressed once during playback, the track being played will be played from the beginning.
- Operation also is possible with the keys I◀◀ and ▶▶I of the remote control unit.

To fast forward and backward (Remote control unit only)

Backward search

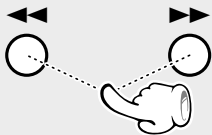

Forward search

- Playback starts from the position where the key is released.

The display changes.

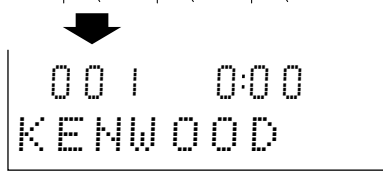

Disc title

Track No. being played

Elapsed time of track being played

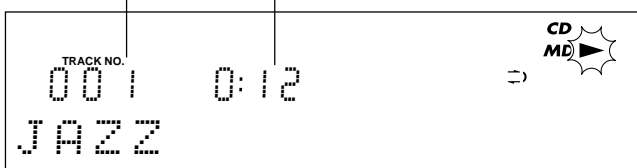

Track title

To pause playback



- Each press pauses and plays the MD alternately.

To stop playback



Ejecting the disc

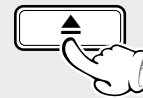

- The minidisc comes out from the minidisc insertion slot.

Time display on MD recorder (Remote control unit only)

Each press of the TIME key changes the displayed contents.

- ① 1:23 (Elapsed time of track being played)
- ② - 2:37 (Remaining time of track being played)
- TOTAL
- ③ 23:45 (Elapsed time of entire disc)
- TOTAL
- ④ - 36:15 (Remaining time on entire disc)

Disc recorded in monaural mode

This unit is capable of playing a disc recorded in the monaural mode.

As the amount of data required to record information in the monaural mode is half the amount required in the stereo mode, the play (record) time of a disc recorded in the monaural mode is twice (max. 148 minutes) that of a disc recorded in the stereo mode.

Searching a desired track by its title (TITLE SEARCH)

When the titles of the tracks recorded on a minidisc for recording are entered in advance, search by title is possible for the tracks to be played. → 50

① Select the "MD" input.



② To stop playback.



③ Confirm that the "PGM" indicator is not lit.



④ Press the TITLE SEARCH key.



(To abort operation, press the TITLE SEARCH key again)

⑤ Select the desired title.



To smaller track No. To larger track No.

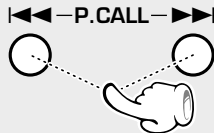

⑥ Start playback.



- When the "PGM" indicator is lit, press the **PGM** key on the remote control unit to switch it off.

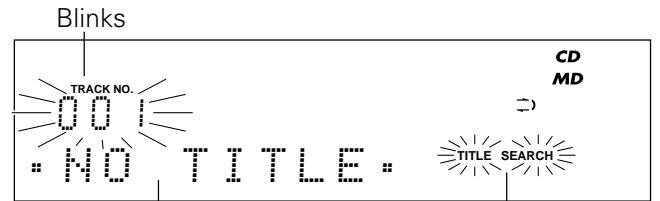
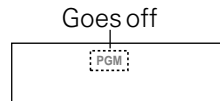

- With a track to which no title has been assigned, the track number and "NO TITLE" are displayed.
- Track selection is possible with the **◀◀** or **▶▶** key of the main unit.

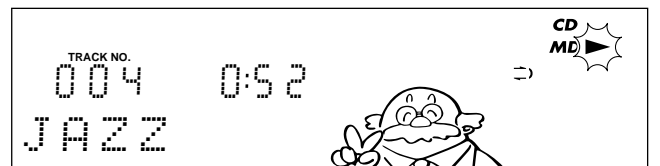
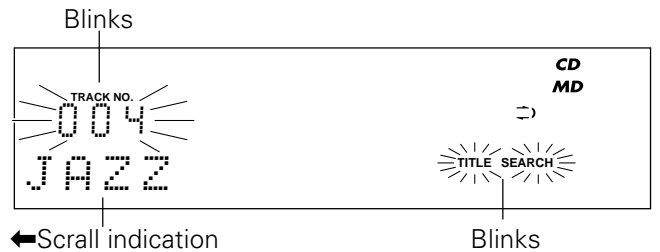

In regard to the DOT/CHARA. key

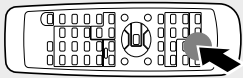

When a title recorded in a CD-TEXT or MD disc is too long to be displayed in the dot display, press this key to scroll the display and view the characters which has not be displayed.
With an MD, this key is also used to switch the dot display modes.

With a CD-TEXT or MD disc

(When pressed during stop)

Scrolls the disc title display.

World Music

(When pressed during playback)

Scrolls the track title display.

New York # Bi

MD

(When pressed during stop or playback)

Each press switches the information.

① Title display

KENWOOD

② Title scroll display

KENWOOD

(Return to ① after title scroll display.)

③ Pressing during title scroll display ② shows the available recording time of the MD.

001 R54:32

(The display returns to ① in 5 seconds.)

- When no track name (track title) and no disc name (disc title) has been recorded, "NO TITLE" is displayed.
- "BLANK DISC" is displayed when not even one track has been recorded. (When there is a disc title, the disc title will be displayed.)

(When pressed during MD recording)

Each press switches the information.

① Recording input display (The title is displayed with a CD-TEXT)

CD

② Available recording time of MD

001 R54:32

Playback of tape



If you load a tape in the cassette deck in advance while the power is off, pressing the TAPE key turns power on automatically and starts the tape playback.

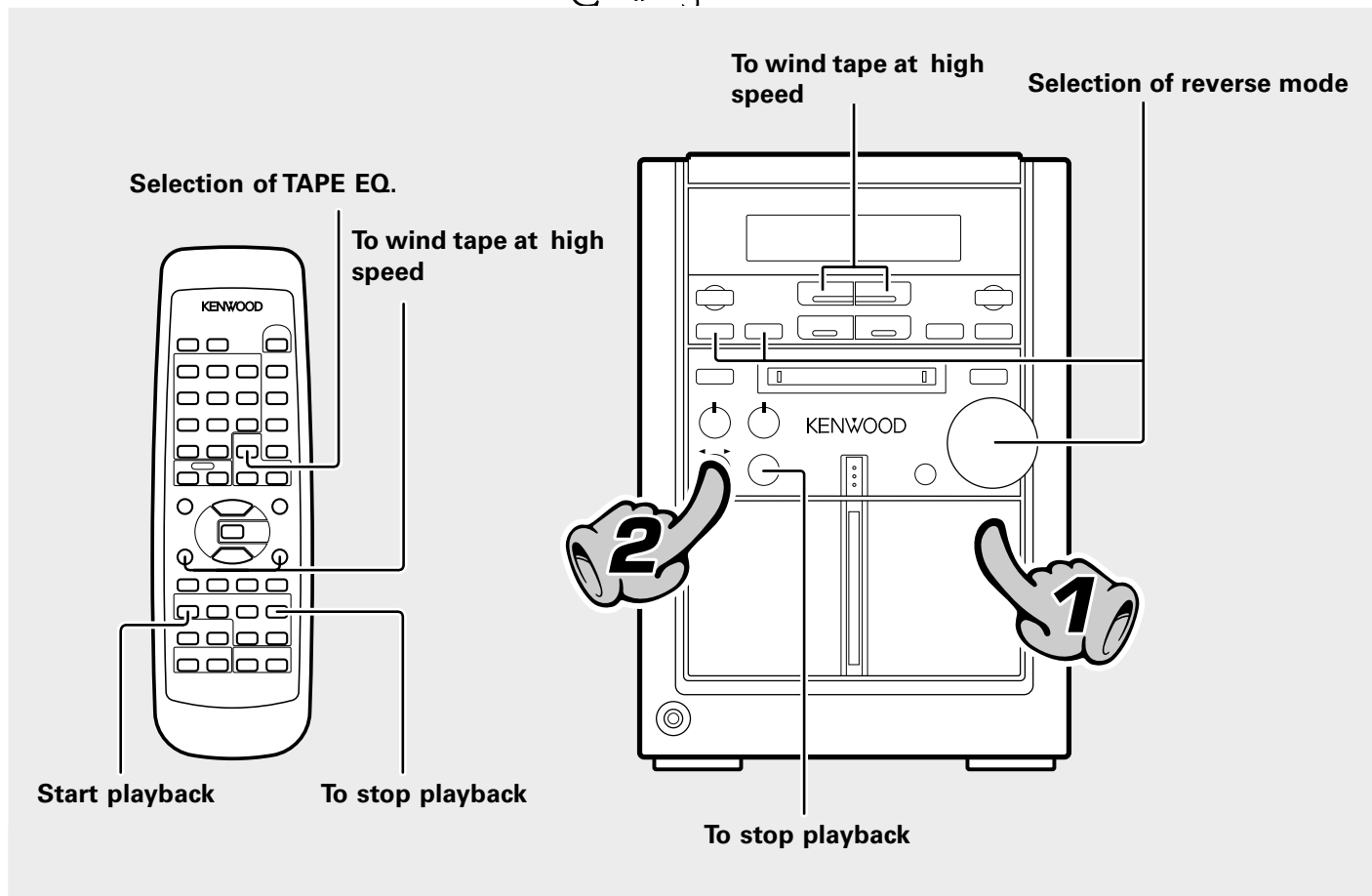

1. Load a cassette tape.

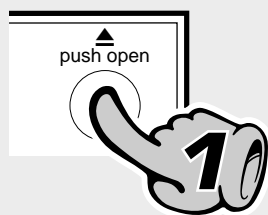

- ① Open the door.
- ② Insert a tape and close the door.

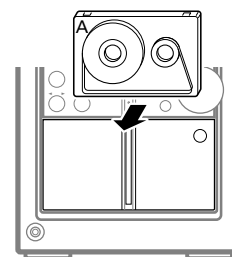

Transport direction indicators



2. Start playback.

During playback, the tape running direction changes each time the key is pressed.

Transport direction indicators

The "direction" indicators show the current direction in which the tape advances when playback or recording is started automatically by the one-touch operation, etc. This direction is the direction stored in memory when the tape was last stopped.

(To change the tape transport direction, press the TAPE key (◀, ▶) during playback then press the stop key (■).)

To wind tape at high speed

To fast wind in direction ←

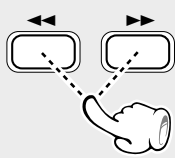

To fast wind in direction →

- Press the  key to stop fast winding.

Selection of TAPE equalizer (TAPE EQ.) (Remote control unit only)

When playing a tape prerecorded with Noise Reduction system (such as the DOLBY NR) ON, be sure to set the "tape EQ." ON for playback.

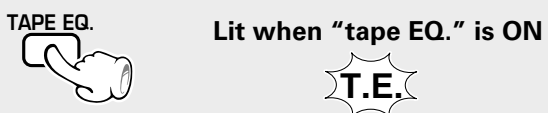

Lit when "tape EQ." is ON

Each press switches the modes as follows.

- ① "tape EQ." ON..... TAPE equalizer is used.
- ② "tape EQ." OFF TAPE equalizer is not used.

- Select the "tape EQ." ON mode according to the recording condition of the tape.

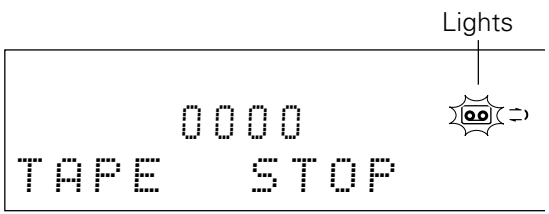

- Normal (TYPE I), high (TYPE II), or metal (TYPE IV) tape selection is set automatically.
- Remove tape slack before loading.
- Close the door securely.

Displayed when the deck is loaded with a tape.

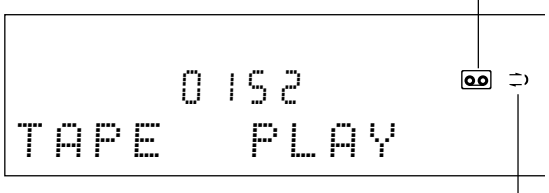

Reverse mode indication

To stop playback



- Do not take out the cassette tape until the tape transport has stopped completely.

Selection of reverse mode (Main unit only)

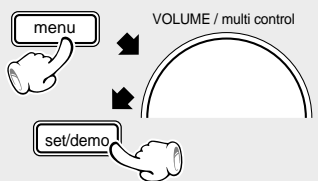
- ① Select "TAPE RVS. ?".
 

(Press the "set/demo" key while the "?" mark is blinking.)
- ② Select.

Initial setup

"↔": (REVERSE)
Both sides are played back (recorded), and then the tape stops.

"⇐": (ONE-WAY)
Only one side is played back (recorded), and then the tape stops.

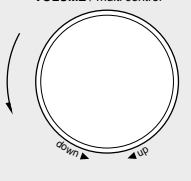

"↻": (ENDLESS)
Both sides are played back endlessly. (The tape stops after recording onto both sides.)
- ③ Set it.
 

Tape counter display (Remote control unit only)

Each press of the TIME key changes the displayed contents.

- ① 0000 (Tape count)
- ② 8:45 (Time display) AM

A tip for use of the tape counter

The tape counter is set to "0000" when a cassette tape is loaded.

By writing down the counter reading in case you want to interrupt recording (playback) in the middle of the tape, the memo will be helpful as a reference for locating the same position when continuing the recording (playback) the next time. The tape counter figure decrements during recording or playback of the back side (while the ◀ tape transport indicator is lit).

To set the tape counter to "0000", open the cassette holder once. Then the counter will be reset.

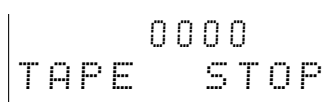

Receiving broadcast station

It is also possible to receive them by one-touch operations by storing up to 40 stations in the preset memory.



When the "TUNER band" key is pressed, the unit will automatically be switched on and reception status will be reached.

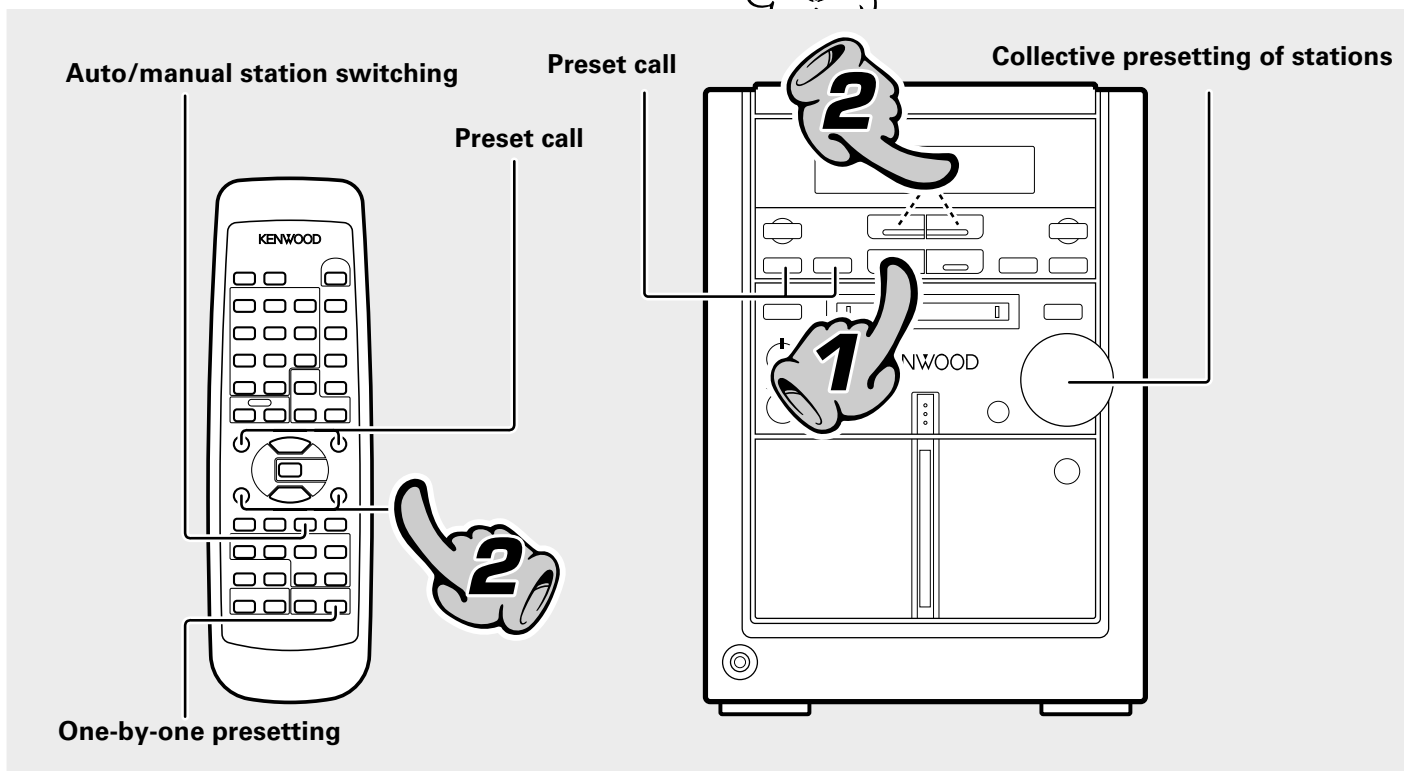

1. Select the broadcast band.

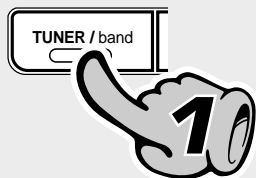

Each press changes the band.

- ① FM
- ② AM

Select a station

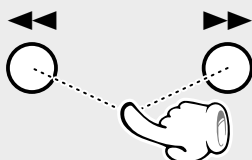

2. Select a station.

When no stations have been memorized

Auto tuning : The next broadcasting station will be received automatically each time this key is pressed.

Manual tuning : Press the key repeatedly or hold it depressed until a station is received.

Select a station

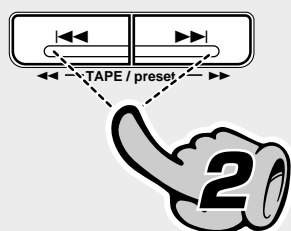

When stations have been memorized (preset call)

Every time the key (◀◀ or ▶▶) is pressed, the preset stations are switched over as follows.

Press ▶▶ for the order of 1→2→3 ... 38→39→40→1...

Press ◀◀ for the order of 40→39→38 ... 3→2→1→40...



Collective presetting of stations (auto preset)

① Receive a broadcast.

② Select "A. MEMORY?".

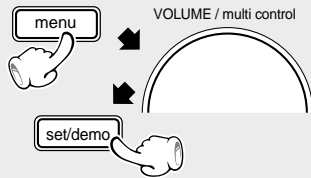

(Press the "set/demo" key while the "?" mark is blinking.)



- A maximum of 40 stations of the band presently being received will be preset.
- When there are many stations and the intended station has not been preset, please also use "One-by-one presetting (manual preset)".

One-by-one presetting (manual preset)

① Press the ENTER key during reception.



(Proceed to step ② while "MEMORY" is lit.)

"MEMORY" lights (for approx. 5 sec.)

② Select one of the preset numbers from 1 to 40.

The numbers become smaller

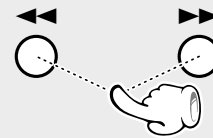

The numbers become larger

③ Press the ENTER key again.



(Repeat steps ①, ②, ③ to preset other stations)

- If several stations are preset under the same number, the previous memory is replaced with the latest memory contents.

Reception band indication

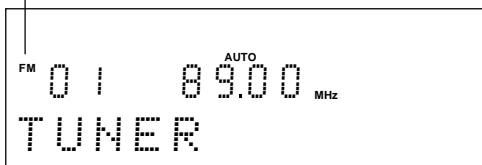

Lights at the time of automatic station selection. The "TUNED" indicator lights when a station is received.

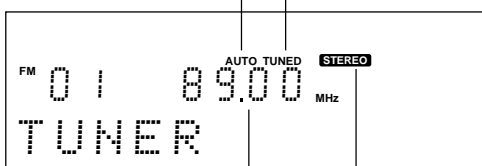

Frequency display

Lights during stereo reception

- When a key is held depressed, preset stations will be skipped at an interval of about 0.5 second.
- Preset stations can be called using the number keys on the remote control unit.

Tuning mode switching and reception mode (Remote control unit only)



Each press alternates the mode.

- ① "AUTO" lit (Auto tuning, stereo reception)
- ② "AUTO" not lit (Manual tuning, monaural reception)

Use the manual tuning mode when reception is noisy due to weak reception. (In the manual mode, stereo broadcasts are received in monaural.)

- Normally, use the **AUTO** (Auto tuning, stereo reception) mode.

Tuner frequency display (Remote control unit only)

Each press of the TIME key changes the displayed contents.



Recording on MD

This unit cannot record audio in monaural mode.

MD recording is possible as "digital recording", where the digital signal of the CD is used as it is, and as "analog recording", where the analog signal of a broadcast etc. is converted to a digital signal.

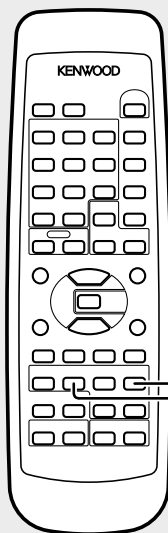

Stop the recording

Pause the recording

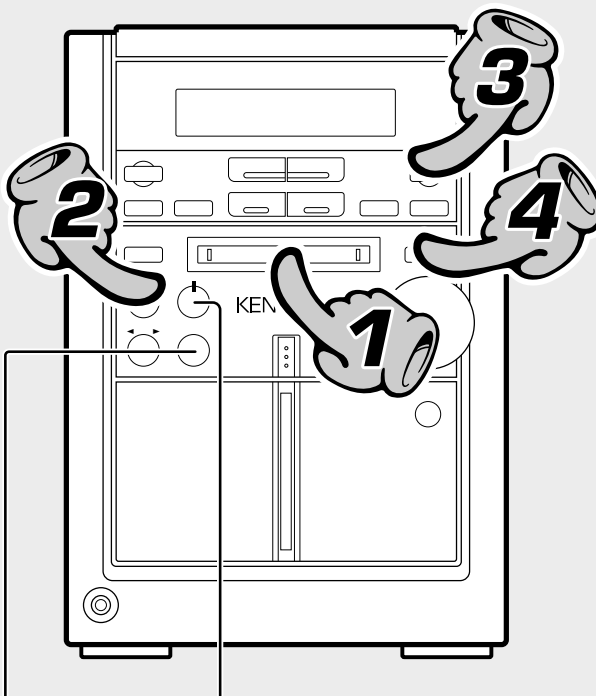

Stop the recording

Pause the recording

Basic section

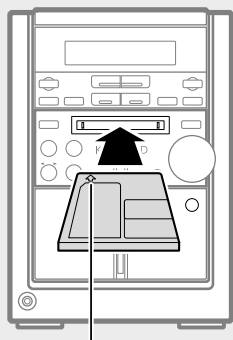

In the direction of the arrow

1. Make the preparations for recording.

- ① Open the write protect tab of the Mini Disc to make it recordable.
- ② Load the Mini Disc. 

CAUTION

The MD cannot be loaded or ejected while the unit is in standby mode. Do not force load a MD in standby mode, otherwise malfunction will result.

Select an input source other than "MD"

Example:
To select the CD input

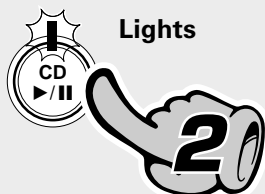

Lights

2. Select the source to be recorded.

- TUNER (Broadcasts) : Only analog recording
- CD : Only digital recording
- TAPE : Only analog recording
- AUX (tape etc.) : Only analog recording

- If a CD or tape has already been loaded, it starts to play now. Press the ■ key to stop it.
- If the CD input is selected, the digital input is recorded automatically.

CD

The character information display shows the recording input source.

Pause the recording

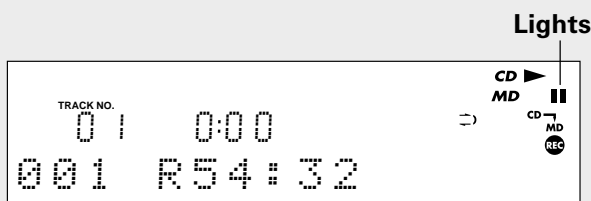

The recordable time for the MD is displayed.

- Press the key again to resume recording. At this time, the track number is incremented by "1".
- Recording can also be started by pressing the "MD rec" key.

In regard to track numbers at the time of recording

When a part without sound continues for 2 sec. or more during recording, the track number is automatically increased by "1" when the next sound enters. When classic music continues with low sound, the track number may be increased by "1". (The track number is not increased during recording of the tape or tuner input.)

The erroneously set track number can be erased later. When it is desired to increase the track No. during recording, press the TRACK EDIT key during recording to record a track No. at that position.

The track numbers are used at the time of playback to find the start of tracks, for programming, etc.

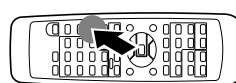

Press during recording.



- With digital recording from a CD, the track number is increased when the track changes.



At the time of recording from a CD, the track number may be incremented when CD playback starts. This occurs because of a signal included in the digital signal from the CD. Delete unwanted track numbers under reference to "TRACKERASE or ALL ERASE".

→ 59

Stop the recording

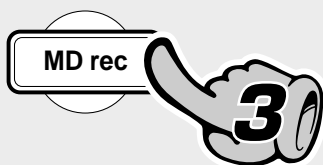

3. Start recording.

- 1 Press the "MD rec" key (the unit enters record-pause mode).
- 2 When the preparation is complete, press the "MD rec" key again.
- 3 Play the music source to be recorded.

- For recording from a CD, read "One-touch recording".

→ 45

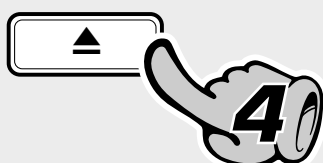

4. Remove the minidisc after the end of recording.

Always remove the minidisc after recording.

"WRITING" displayed during the minidisc ejection operation indicates that the data associated with recording or editing is being written on the disc. Do not apply vibration or shock to the unit while this message is displayed.

In regard to display messages

Recording is not possible when one of the following messages is displayed.

- | | |
|--|-----------------------------|
| "DISC FULL" : The minidisc is full. | → Erase unrequired tracks. |
| "PROTECTED" : The write protect tab is open. | → Close it. |
| "PLAY ONLY" : The minidisc is only for playback. | → Insert a recordable disc. |

→ 59 → 71 → 72
→ 8 → 71
→ 71

Recording on TAPE



Note that this cassette deck cannot record onto Metal tapes.

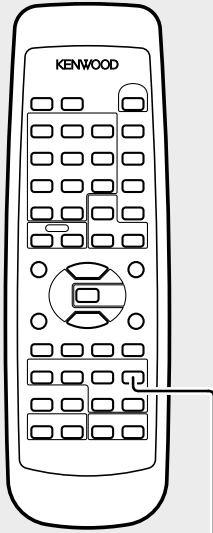

Stop the recording

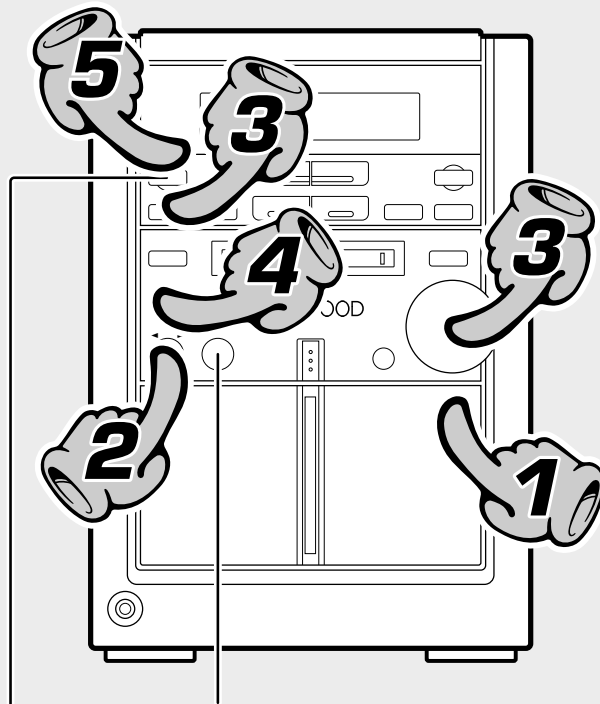

Pause the recording

Stop the recording

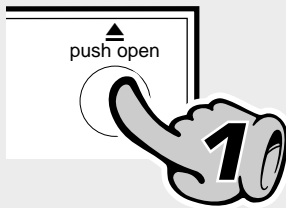

1. Load a tape in deck.

- ① Open the door of deck.
- ② Insert a tape.
- ③ Close the door.

- Differentiation between normal (TYPE I) and high (TYPE II) tape is set automatically.
- Remove tape slack before loading.

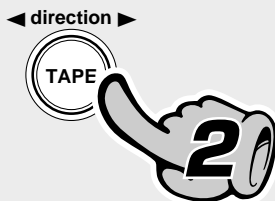

2. Select the tape transport direction.

To reverse the transport direction

- ① Press the play key.
- ② Press the play key again.
- ③ Stop playback.

- When recording is started, the tape is transported in the direction selected in this step.
- Wind the tape to the position where recording is to be started.

Check the tape transport direction indicator. → 26

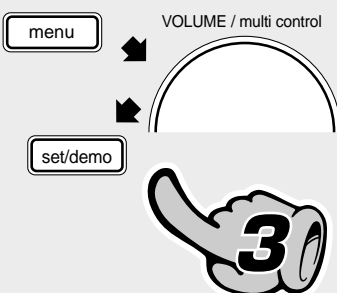

3. Set the recording condition.

Select the reverse mode. → 27

Pause the recording



Blinks



- Press the "TAPE rec" key during recording. It stops after leaving a non-recorded blank of 4 seconds. (Press the key again to resume recording.)

Stop the recording



Points in CD recording

When recording CD tracks onto a tape, if you leave the cassette deck in record-pause mode beforehand, the cassette deck recording can be started at the CD starts to be played. (Synchro recording function)

- ➊ Put the CD player in pause mode.
- ➋ Select the track to be recorded with the skip (◀◀, ▶▶) keys. (The CD player pauses at the beginning of the selected track.)
- ➌ Put the cassette deck in Record-pause mode. (Press "TAPE rec" key twice)
- ➍ Start playing the CD. (Synchro recording starts)

- Recording stops when the stop (■) key of the CD player is pressed.
- Synchronized recording from MD also is possible with the same procedure.

Select an input source other than "TAPE"

Example:
To select the CD input



4. Select the source to be recorded.

TUNER (Broadcasts)
CD
MD
AUX (External input)

CD

The character information display shows the recording input source.

- If a CD or MD has already been loaded, it starts to play now. Press the ■ key to stop it.

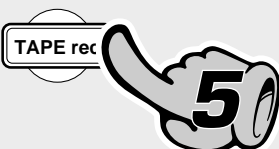

5. Start recording.

- ➊ Play (or tune) the input source to be recorded.
- ➋ Start recording.

- Recording stops automatically when the tape side (s) to be recorded have been fully recorded.

Listening in the desired sequence (program playback)

Use the following procedure to program desired tracks in a desired order. (up to 32 tracks)

Select the "CD" input.

1 Let the "PGM" indicator light.

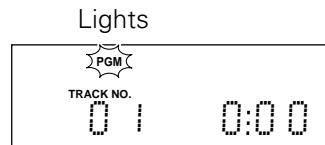

2 Select track numbers in the order you want to play them.

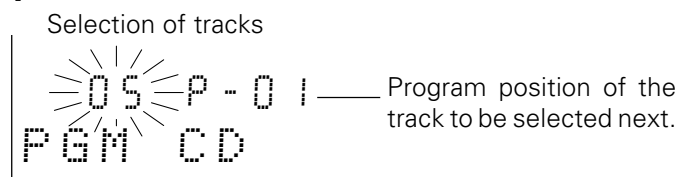
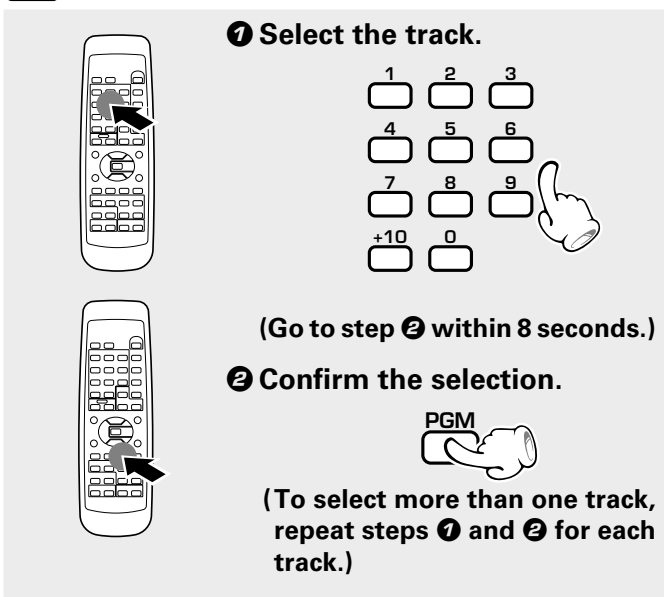

Press the numeric keys as shown below....

To select track No. 23 : **+10 +10 3**

To select track No. 40 : **+10 +10 +10 +10 0**

- Up to 32 tracks can be programmed. When "FULL" is displayed, no more tracks can be programmed.
- If you made a mistake, press the **CLEAR DELETE** key and enter the track No. again.
- When a track No. is entered, the track will be added to the end of the existing program.
- "-- : --" is displayed when the total programmed period has attained 100 minutes or more.

3 Start playback.

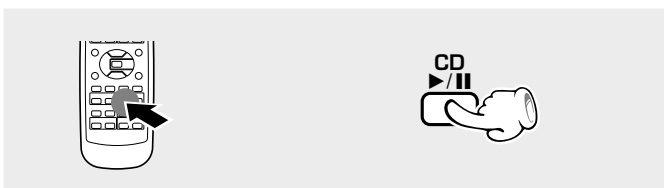

- Tracks will be played in the order they were programmed (following the program numbers).
- When the **◀◀** or the **▶▶** key is pressed during play, the program will jump to the preceding or the following track respectively.
- When the **◀◀** key is pressed once during playback, the play position returns to the beginning of the current track being played.

To stop playback

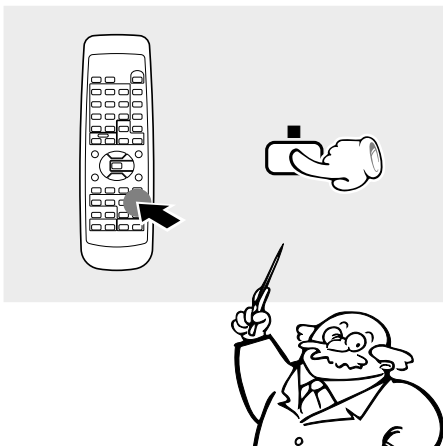

To quit the program mode

Clearing tracks from the end

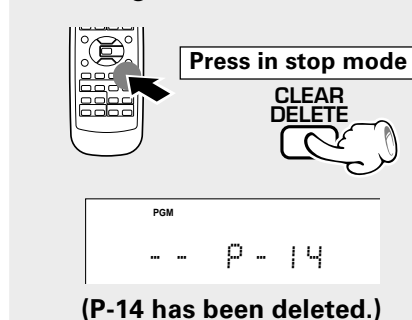

(P-14 has been deleted.)

- Each time the key is pressed, the last track in the program is cleared.

Clearing all tracks

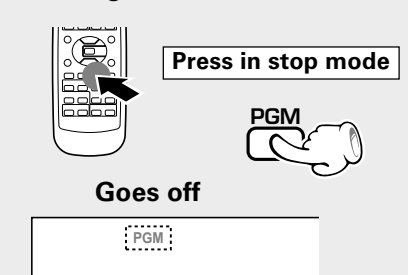

Goes off

- The entire program is cleared.

Repeated playback

You can repeatedly listen to a favorite track or disc.

Select the "CD" input.

Setup for repeating a single track

- 1 Confirm that the "PGM" indicator is not lit.



(If the "PGM" indicator is lit, press the PGM key to turn it off.)

- 2 Select "REPEAT".



Confirm that this is not lit.

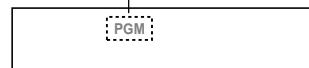

Each press switches the repeat mode.

- 1 REPEAT
- 2 REPEAT ALL
- 3 Off.... Repeat deactivated

Lights



Setup for repeating all tracks in a disc

- 1 Confirm that the "PGM" indicator is not lit.



(If the "PGM" indicator is lit, press the PGM key to turn it off.)

- 2 Select "REPEAT ALL".



Confirm that this is not lit.

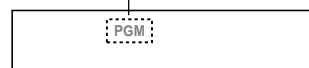

Each press switches the repeat mode.

- 1 REPEAT
- 2 REPEAT ALL
- 3 Off.... Repeat deactivated

Lights



Setup for repeating selected tracks

- 1 Program the track sequence according to steps 1 to 2 of "Listening in the desired sequence". - 34



- 2 Select "REPEAT".



"REPEAT", "PGM" light.

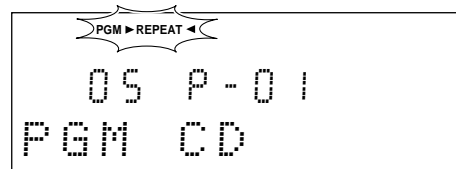

- All selected tracks will be repeated.

Start playback



To stop repeated playback

Press the REPEAT key repeatedly until the repeat mode is switched off.

- The "REPEAT" or "REPEAT ALL" indicator turns off and playback according to the current CD player mode starts.

Listening to an unexpected title sequence (random playback)

As the titles each time are selected randomly, the music can be enjoyed without getting tired of it.

Select the "CD" input.

1 Confirm that the "PGM" indicator is not lit.

(If the "PGM" indicator is lit, press the PGM key to turn it off.)



Confirm that this is not lit.

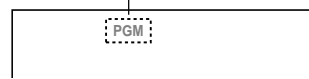

2 Press the RANDOM key.



Each press switches the modes as follows.

- ① "RANDOM" on ... Random playback
- ② "RANDOM" off ... Normal playback

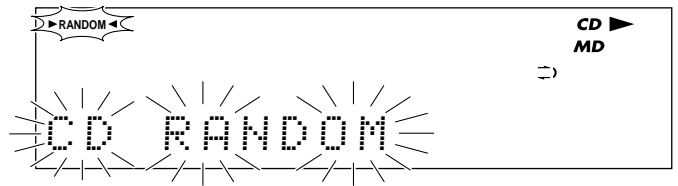

- Playback stops after each title has been played once.
- The random playback can also be repeated by pressing the **REPEAT** key.



To select another track in the middle of playing one

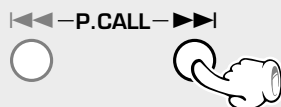

- Pressing the P.CALL key once returns to the beginning of the track being played.

To cancel random playback

Press so that the "RANDOM" indicator goes off.



- The "RANDOM" indicator goes off and the playback in order of the tracks starts from the track being played.

Listening in the desired sequence (program playback)

Use the following procedure to program desired tracks in a desired order. (up to 32 tracks)

Select the "MD" input.

1 Let the "PGM" indicator light.

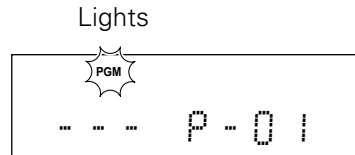

2 Select track numbers in the order you want to play them.

1 Select the track.

(Go to step 2 within 8 seconds.)

2 Confirm the selection.

(To select more than one track, repeat steps 1 and 2 for each track.)

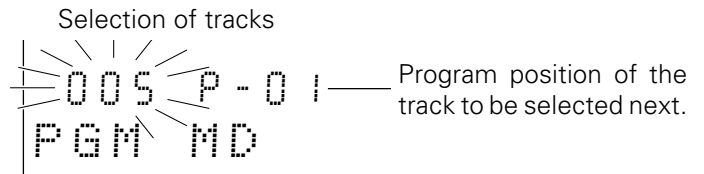

Press the numeric keys as shown below....

- To select track No. 23 : **+10** **+10** **3**
- To select track No. 40 : **+10** **+10** **+10** **+10** **0**

- Up to 32 tracks can be programmed. When "FULL" is displayed, no more tracks can be programmed.
- If you made a mistake, press the **CLEAR DELETE** key and enter the track No. again.
- When a track No. is entered, the track will be added to the end of the existing program.
- An extremely short track cannot be programmed.
- "-- : --" is displayed when the total programmed period has attained 100 minutes or more.

3 Start playback.

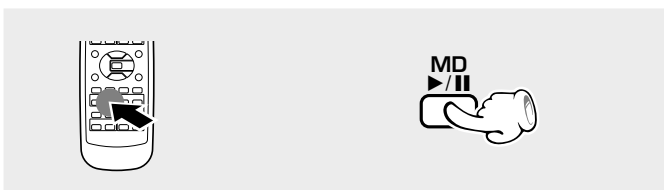

- Tracks will be played in the order they were programmed (following the program numbers).
- When the **I◀◀** or the **▶▶I** key is pressed during play, the program will jump to the preceding or the following track respectively.
- When the **I◀◀** key is pressed once during playback, the play position returns to the beginning of the current track being played.

To stop playback



To quit the program mode

Clearing tracks from the end

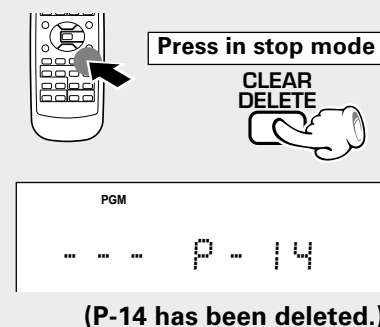

- Each time the key is pressed, the last track in the program is cleared.

Clearing all tracks

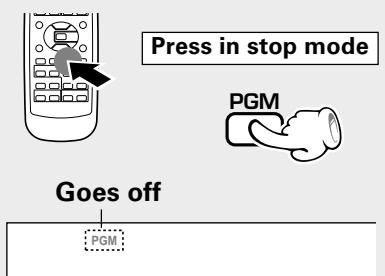

- The entire program is cleared.

Repeated playback

You can repeatedly listen to a favorite track or disc.

Select the "MD" input.

Setup for repeating all tracks in a disc

- 1 Confirm that the "PGM" indicator is not lit.



(If the "PGM" indicator is lit, press the PGM key to turn it off.)

- 2 Select "REPEAT ALL".



Confirm that this is not lit.



Each press switches the repeat mode.

- 1 REPEAT ALL
- 2 Off....Repeat deactivated

Lights



Setup for repeating selected tracks

- 1 Program the track sequence according to steps 1 to 2 of "Listening in the desired sequence".



→ 37

- 2 Select "REPEAT".



"REPEAT", "PGM" light.

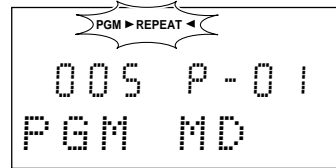

- All selected tracks will be repeated.

Start playback



To stop repeated playback

Press the REPEAT key repeatedly until the repeat mode is switched off.

- The "REPEAT" or "REPEAT ALL" indicator turns off and playback according to the current MD recorder mode starts.

RDS is a system which transmits useful information (digital data) for FM broadcasts together with the broadcast signal. Tuners and receivers designed for RDS reception can extract the information from the broadcast signal for use with various functions such as automatic display of the station name.

This unit is equipped with the following functions utilizing RDS data :

PTY (Program Type Identification) Search : → 40

The tuner automatically searches for a station which is currently broadcasting a specified program type (genre).

PS (Program Service Name) Display :

When an RDS broadcast is received, the station name is automatically displayed.

EON (Enhanced Other Network) : → 42

When the information to be received is set in advance and any RDS station in the same network starts broadcasting of such information, the reception automatically will be switched to that station.

The "RDS" indicator lights up when an RDS broadcast (signal) is received.

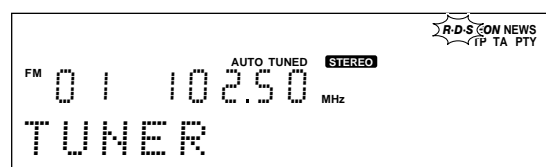

- Some functions may not be provided or be given different names depending on countries or areas.

Before using RDS

For reception of RDS stations, the auto presetting function must be used to preset the stations. With the auto presetting function, RDS stations are preset with priority. "NO DATA" will be flashed when a station is not preset by auto presetting.

Searching for a desired program type (PTY search)

By specifying the type of program (genre) you want to listen to, the tuner automatically searches for a station which is currently broadcasting a program of the specified type.

Set the reception band to FM. Preset RDS stations with the auto preset function. → 29

1 Select the PTY search mode.

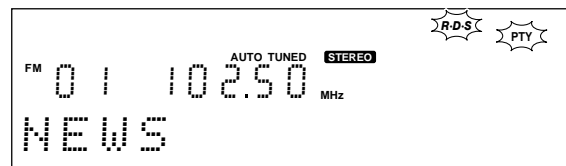
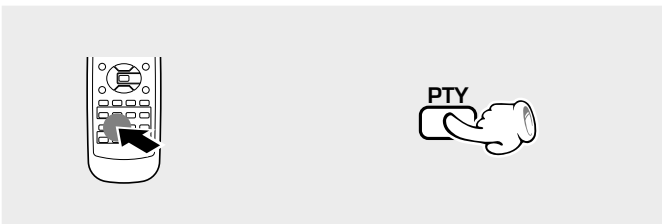

When an RDS broadcast is received, the program type is shown on the display. If no PTY data is available, or if the station is not an RDS station, "NONE" is displayed.

2 Select the desired program type.

Use program type table on the right for your convenience.

A Selection with the ◀▶ keys

Select while "PTY" is lit.

The desired program type can be selected with the ◀▶ keys from 29 types. Press the key and release it when the desired type is displayed.

B Selection with the numeric keys

The program types 1 to 9 and 0 can be selected directly with the number keys. Use the ◀▶ keys to select other program types.

Program type table

◀▶▶▶ keys	Program Type Name	Display	
DOWN ↑ UP ▶▶	1 Pop Music	POP M	
	2 Rock Music	ROCK M	
	3 *M.O.R. Music	M.O.R. M	
	4 Light Classical	LIGHT M	
	5 Serious Classical	CLASSICS	
	6 Other Music	OTHER M	
	7 News	NEWS	
	8 Current Affairs	AFFAIRS	
	9 Information	INFO	
	0 Sport	SPORT	
		Education	EDUCATE
		Drama	DRAMA
		Culture	CULTURE
		Science	SCIENCE
		Varied	VARIED
		Weather	WEATHER
		Finance	FINANCE
		Children's programs	CHILDREN
		Social affairs	SOCIAL A
		Religion	RELIGION
		Phone in	PHONE IN
		Travel	TRAVEL
		Leisure	LEISURE
		Jazz music	JAZZ
		Country music	COUNTRY
		National music	NATION M
		Oldies music	OLDIES
		Folk music	FOLK M
		Documentary	DOCUMENT

*M.O.R. Music (Middle of the Road Music)

3 Start the search.



- No sound is heard while "PTY" is blinking.
- If a program of the desired type cannot be found, "NO PROG" is displayed, then after several seconds the display returns to the original display.
- If a program of the desired type is found, that program is received and the program type name display changes temporarily to the station name display.

To change to a different program type :

Repeat steps 1, 2, 3.

When searching for a Rock Music broadcast

Display while the tuner is searching.

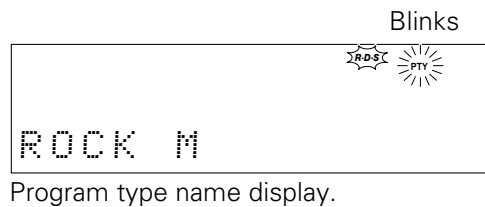

Program type name display.

When a station is received.

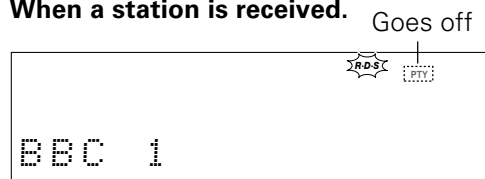

Station name display.

To be able to listen to the desired information at any time (EON)

By using the EON function, which manages the information of other stations, listening to desired information like traffic information or news etc. can be reserved even when it is not being transmitted at the present. When listening to a station with the "EON" display lit and another station of the same network starts to broadcast an information program for which a reservation has been made, then that station will be selected automatically. When the desired information program ends, return is made to the original program.

Set the reception band to FM.



1 Auto preset the stations.

- ① Receive a broadcast.
- ② Select "A. MEMORY ?".

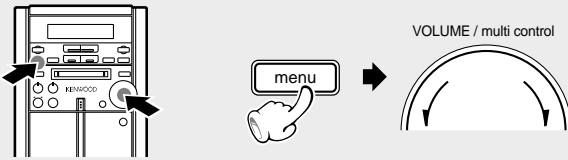

③

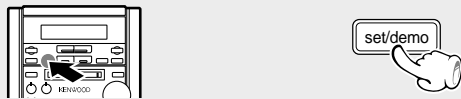

(Press the "set/demo" key while the "?" mark is blinking.)

The EON data presently being broadcasted are taken in automatically.

This is not required when auto presetting has already been executed.



- When all 40 stations have already been preset by the procedure for "One-by-one presetting (manual preset)", the EON function will not operate. Auto presetting must be used.

2 Select the desired information.

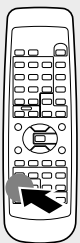

Each press switches the modes as follows.

- ① TA Traffic Announcement
- ② NEWS News
- ③ TA/NEWS Traffic Announcement/ News
- ④ Display not lit EON cancelled

This lights when a station transmits traffic information.

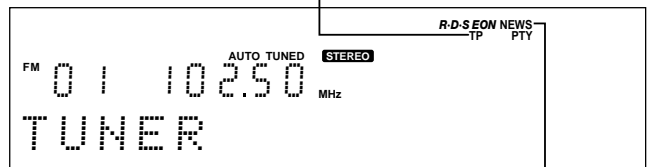

Lights when "NEWS" is selected.

3 Receive an RDS station.

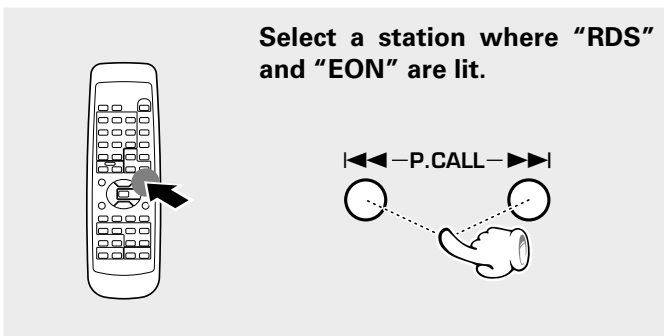

Select a station where "RDS" and "EON" are lit.

"RDS" and "EON" are lit.

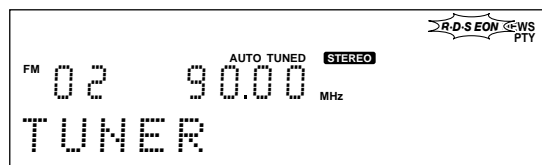

- When "EON" does not light although an RDS station is received, that station is not transmitting EON data. Please select a different station.
- When TA is desired, select a station where the "TP" display lights.

4 Wait for the desired information.

CD, MD or TAPE playback may also be started.

As long as the unit is ON, the unit is always ready for the reception.

- When one of the stations of the network of the station received in 3 starts broadcasting the program contents selected in 2, that station will be received automatically. At this time, Tape playback will stop and CD or MD playback will pause. However, external equipment (AUX) will remain as it is.
- When the unit is OFF or during recording (including dubbing), the EON function does not operate.
- When the transmission of the selected program contents ends in case of automatic reception with the EON function, return will be made to the status directly before operation of the EON function. When CD, MD or TAPE playback has been interrupted, it will be continued from the point of interruption.

In case of waiting for information with an RDS station without EON function

When there is no "EON" display with the operations of steps 3 and 4 and the desired information is selected in advance, waiting for the desired information will be done only with the presently received RDS station.

In regard to TP (Traffic Program) indicator

When the "TP" indicator is lit, this indicates that the station or another station in the same network is broadcasting traffic information. Even without an EON reservation, traffic information can be heard from the station when "TP" indicator is lit for the presently received station.

Selection of the Recording Type

This unit provides the following recording features in addition to normal recording. Select the appropriate method according to the purpose of recording.



Note that this cassette deck cannot record onto Metal tapes.

To record CD with a simplified method

One-touch recording (CD→MD/ CD→TAPE) → 45

One-touch recording (all-track recording) →

One-touch recording of an entire CD onto an MD or tape.

One-touch recording (single-track recording) →

One-touch recording of the CD track being played onto an MD or tape. (This is convenient for recording of desired tracks from a disc being heard for the first time.)

● One-touch recording from an MD to a tape is not possible.

To record CD simultaneously onto an MD and tape

Twin recording onto MD and tape (TWIN REC) (CD→MD, TAPE) → 46

TWIN REC (all-track twin recording) →

Simultaneous recording of an entire CD onto an MD and tape.

TWIN REC (single-track twin recording) →

Simultaneous recording of the CD track being played onto an MD and tape. (This is convenient for recording of desired tracks from a disc being heard for the first time.)

To record desired CD or MD tracks by reordering them

Program recording (CD→MD/ CD→TAPE / MD→TAPE) → 47 → 48

Program recording →

Recording of programmed tracks in the programmed order. (Convenient for recording only the desired CD or MD tracks in the desired order.) Program recording can be used in combination with the "One-touch recording" or "Twin recording onto MD and tape (TWIN REC)".



With recording onto tape, the track will be interrupted for the part of the guide tape at the tape reversal, where recording is not possible. Please use single-side recording if this is to be avoided.

One-touch recording (CD→MD /CD→TAPE)

The one-touch recording can record all tracks in a CD with a one-touch operation (all-track recording). It can also record the current CD track being played from the beginning (single-track recording).

Be sure to put the MD recorder and cassette deck in stop mode

1 Make the preparations for recording.

CD → MD

- 1 Insert a recordable disc into the MD recorder.
- 2 Insert disc in the CD player.

CD → TAPE

- 1 Perform steps 1. to 3. of the procedure in "Recording on TAPE". → 32
- 2 Insert disc in the CD player.

2 Check the current play mode of the CD player.

One-touch recording (all-track recording)

If it is in play mode, stop it.



One-touch recording (single-track recording)

Select the desired CD track and play it.



To record other tracks using "one-touch recording (single-track recording)", repeat steps 2 and 3 for each track.

3 Start recording.



- When starting recording from the remote control unit, make sure not to mistake the MD O.T.E. key and TAPE O.T.E. key.
- When the MD O.T.E. or TAPE O.T.E. key is pressed for "One-touch recording (single-track recording)", the CD track being played is replayed from the beginning and recording start at the same time.
- To perform operation on the main unit, see step 2 in the procedure in "Twin recording onto MD and tape (TWIN REC)". → 46

To interrupt a recording

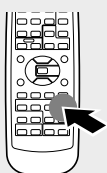

(Recording and playback will be stopped.)

At the end of the recording

- MD recorder : Stop.
- Cassette deck : Stop is executed after an unrecorded portion of about 4 sec. has been produced.



Always remove the disc after recording.

"WRITING" displayed during the minidisc ejection operation indicates that the data associated with recording or editing is being written on the disc. Do not apply vibration or shock to the unit while this message is displayed.

Twin recording onto MD and tape (TWIN REC) (Main unit only)

All the tracks on a CD can be recorded simultaneously onto an MD and tape. (All-track twin recording)
The current track can be recorded from the beginning simultaneously onto an MD and tape. (single-track twin recording)

Be sure to put the MD recorder and cassette deck in stop mode.

1 Make the preparations for recording.

- ① MD : Perform steps 1. of the procedure in "Recording on MD".
- TAPE : Perform steps 1. to 3. of the procedure in "Recording on tape".
- ② Insert disc in the CD player.



2 Check the current play mode of the CD player.

TWIN REC (all-track twin recording)

If it is in play mode, stop it.



TWIN REC (single-track twin recording)

Select the desired CD track and play it.



To record other tracks using "TWIN REC (single-track twin recording)", repeat steps ② and ③ for each track.

3 Start recording.

- ① Select "REC MODE ?" then "TWIN REC ?".



- ② Start recording.

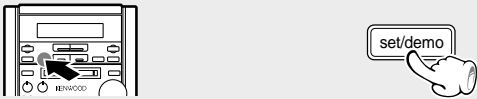

Turning the knob switches the function as shown in the character information display.

- ① CD → MD ? (Can be selected from the remote control unit or main unit)
- ② CD → TAPE ? (Can be selected from the remote control unit or main unit)
- ③ TWIN REC ? (Can be selected on the main unit only)

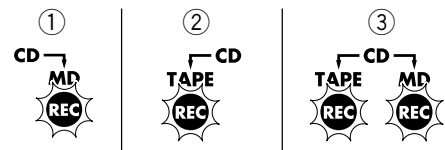

- If the "set/demo" key is pressed when the "TWIN REC (single-track twin recording)" mode is set, the pickup returns to the beginning of the track that is currently playing, the "REC" indicator lights and recording starts.

To interrupt a recording

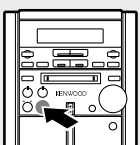

(Recording and playback will be stopped.)



At the end of the recording

- MD recorder : Stop.
- Cassette deck : Stop is executed after an unrecorded portion of about 4 sec. has been produced.

"WRITING" displayed during the minidisc ejection operation indicates that the data associated with recording or editing is being written on the disc. Do not apply vibration or shock to the unit while this message is displayed.



Always remove the disc after recording.

Program recording (CD → MD / CD → TAPE)

Desired CD tracks can be programmed in the desired sequence and recorded onto an MD or tape.

Recording preparation is required. → 30 → 32
(Be sure to put the MD recorder and cassette deck in stop mode.)

1 Program the desired sequence of CD tracks.

CD → MD

Perform steps **1** and **2** of the procedure in "Listening in the desired sequence (Program playback)". → 34

CD → TAPE

Perform steps **1** and **2** of the procedure in "Listening in the desired sequence (Program playback)". → 34

- When the **PGM** key is pressed to cancel the edited contents, the entire editing contents will be erased.
- Tracks programmed beyond the available MD or tape recording time will be interrupted in the middle.

2 Start recording.

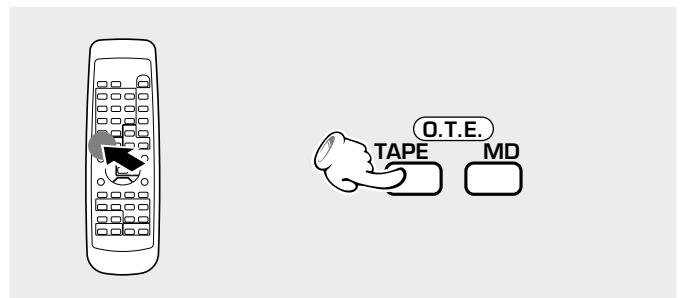
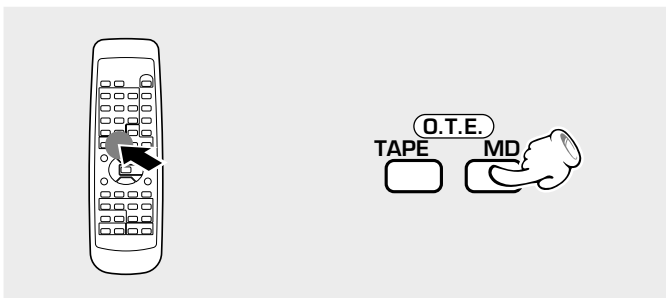

- Recording of the programmed tracks in the programmed order starts.
- When starting recording from the remote control unit, make sure not to mistake the **MD O.T.E.** key and **TAPE O.T.E.** key.
- To perform operation on the main unit, see step **2** in the procedure in "Twin recording onto MD and tape (TWIN REC)".

→ 46

To interrupt a recording

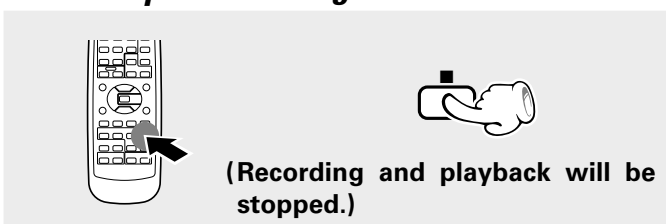

At the end of the recording
MD recorder : Stop.
Cassette deck : Stop is executed after an unrecorded portion of about 4 sec. has been produced.

"WRITING" displayed during the minidisc ejection operation indicates that the data associated with recording or editing is being written on the disc. Do not apply vibration or shock to the unit while this message is displayed.

Always remove the disc after recording.

Program recording (MD → TAPE)

Desired MD tracks can be programmed in the desired sequence and recorded onto a tape.

Recording preparation is required. →  32 (Be sure to put the cassette deck in stop mode.)

1 Program the desired sequence of MD tracks.

MD → TAPE

Perform steps **1** and **2** of the procedure in "Listening in the desired sequence (Program playback)". →  37

- When the **PGM** key is pressed to cancel the edited contents, the entire editing contents will be erased.
- Tracks programmed in excess of the tape recording time will be cut off.

2 Put the MD recorder in pause mode before starting program playback.

(Press twice.)

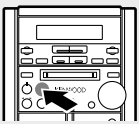

3 Put the tape deck in record-pause mode.

(Press twice.)



4 Start recording.



- Starting the MD program playback starts tape recording by synchro recording.

To interrupt a recording



(Recording and playback will be stopped.)



At the end of the recording

Cassette deck : Stop is executed after an unrecorded portion of about 4 sec. has been produced.

Selecting the editing function type

When a commercially available Mini Disc fabricated for user recording is used, various editing operations can be applied after recording. Note that editing is not possible with commercially available prerecorded Mini Disc software designed for playback only.

Function Limitations because of the MD Standard

Some of the functions are limited because of the MD standard. Please check this before assuming a malfunction. → 71

For editing, set the write protect tab of the mini disc to "Write enable" side. → 8

Assigning a Title to a Disc or a Track → 50

Changing or deleting a title → 52

Title input is possible simply by selecting one character after another from the characters shown on the display. As the entered title is compatible between models, it will be displayed also when the disc is set into a different MD recorder (player). (The title compatibility is limited partly according to the character types which can be displayed, the number of characters, etc.)

Reordering tracks by moving them
Moving several tracks at a time (QUICK MOVE) → 53

Moving a single track (TRACK MOVE) → 55

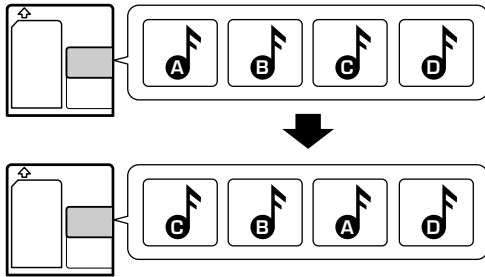

Dividing a track, combining two tracks

TRACK DIVIDE → 57

TRACK COMBINE → 58

Dividing a track into two

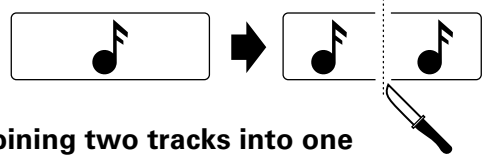

Combining two tracks into one

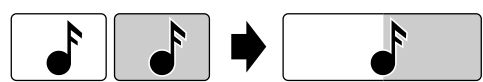

Erasing track(s)

Erasing a single track (TRACK ERASE) → 59

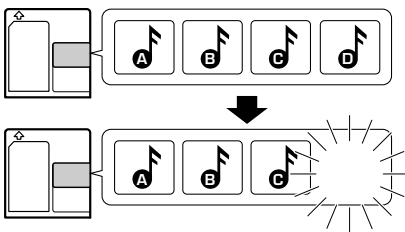

Erasing all tracks on a disc (ALL ERASE) → 59

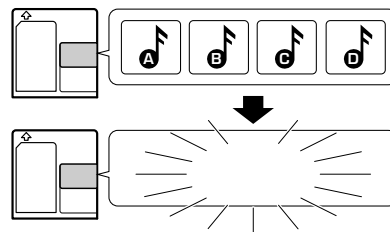

In regard to display scrolling

When the character information for the titles of mini discs or titles is too long, it cannot be displayed all at once. In such a case, the characters on the display scroll from the right to the left and the rest of the information can be seen. This is called scrolling.

Scrolling image

Displayed area (All cannot be displayed.)

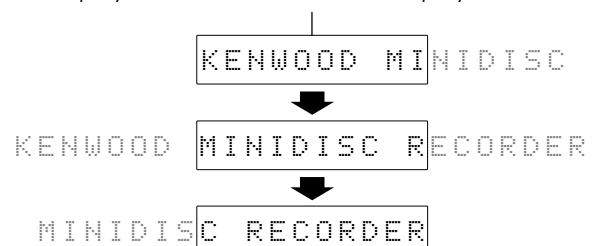

Assigning a title to a disc or track

When titles are assigned to a disc and its tracks, the titles cannot only be displayed during playback but title search (searching a track by the title) is also made possible. The assigned titles can be changed or deleted with the same procedure.

The MD operates on the basis of the information read from the disk into memory. Always remove the minidisc after title input or editing.

Execute operation in stopped condition or during playback.

1 Activate the title input mode.

① Press the TITLE INPUT key.



② Select whether the disc title or track title input.

To return To advance



③ Set the selection.

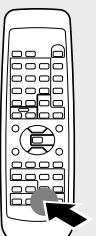

(To abort operation, press the TITLE INPUT key again.)



Disc titles can be assigned in stop mode. When the MD ►/II key pressed before step ①-③ while assigning a title to a track, the title can be entered while listening to that track.

- It takes a while because data should be read out of the disc.

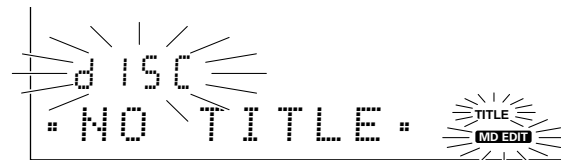

In case of disc title

Select "dISC".

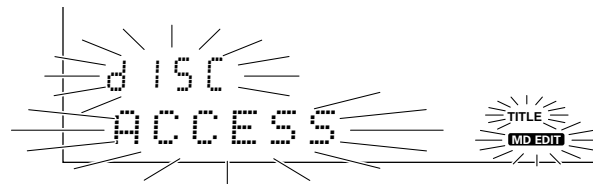

In case of track title

Select the desired track No.

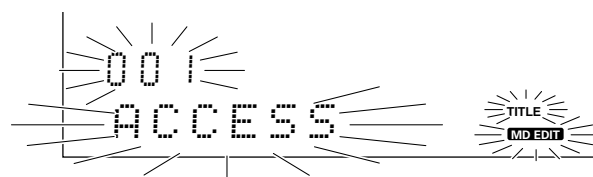

List of registered symbols (ASCII codes):

! " # \$ % & ' () * + , - . / : ; < = > ? @ _ ` ^

Total number of title characters

Up to 1792 characters can be input per disc and up to 80 characters can be input per track.

A space (blank character) also require the same amount of data as alphanumeric characters. When deleting a title, it is not recommended to overwrite spaces on previous characters but use the CLEAR DELETE function.

2 *Input the title.*



① Select the group of the characters used in the title.

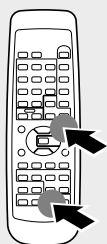

② Select a desired character by placing the selection cursor on it.

To return To advance

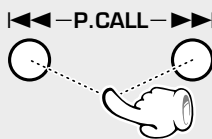

③ Set the selected character.



(Input the title characters by repeating ① to ③ for each of them.)

The following types of characters, numbers, and symbols can be selected. Press the DOT/CHARA. key as often as required to display the desired group of characters.

- A~Z, space (1 blank character)
- a~z, space
- 0~9, symbols, space



- By pressing the ◀◀ or ▶▶ key, the displayed characters are scrolled so any character (in the same group) can be selected.

Example of disc title

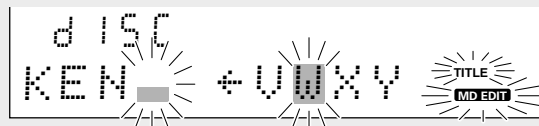

The cursor moves and waits for input of the next character.

3 *Execute title assignment.*



① Enter the title in memory.



② Complete the operation.



← The title scrolls.

4 *After editing, eject and remove the mini disc.*

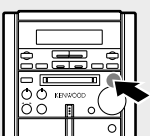

“WRITING” displayed during the minidisc ejection operation indicates that the data associated with recording or editing is being written on the disc. Do not apply vibration or shock to the unit while this message is displayed.

Changing or deleting a title

The MD operates on the basis of the information read from the disk into memory. Always remove the minidisc after title input or editing.

1 Perform step **1** of "Assigning a title to a disc or track".



2 Change or delete characters one by one.

1 Move the cursor to the desired character (the character to be changed).

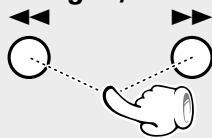

2 Select the character group.



DOT/CHARA.



3 Select overwrite or insert mode.



TITLE SEARCH



4 Select the correct character.

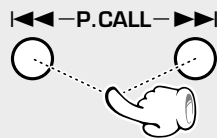

5 Confirm the character.



SET



(All characters of a title can be changed by repeating steps **1** to **5**.)

The input cursor can be moved with the ◀, ▶ keys.

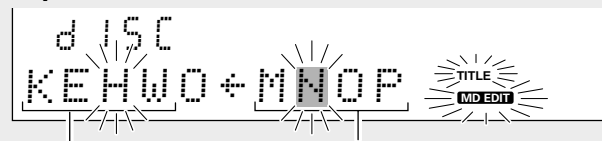

Cursor movement area Character group

Each press of the TITLE SEARCH key switches the operation.

- ① **Overwrite mode** : To replace characters
(The cursor "■" becomes large.)
- ② **Insert mode** : To insert characters before the cursor
(The cursor "■" becomes small.)

- If the title to be changed is too long to be displayed on the display section, press the ◀, ▶ key to scroll the display so that the characters hidden until then appear.

To clear (delete) a character

- 1** Move the cursor under the character to be cleared.
- 2** Clear (delete) the character.



- The character at the cursor is deleted (erased) and the following characters move up by one character each. Titles can be erased easily by continuous pressing (or by holding the key down for repeated input).

3 Execute title change or deletion.

1 Enter the title in memory.



ENTER



2 Complete the operation.

TITLE INPUT



← The title scrolls.

Moving several tracks at a time (QUICK MOVE)

Use the following procedure to change the current order of tracks by selecting a desired order and moving the tracks together.

20 continuous tracks within the specified range can be reordered at a time.

Perform the operations in the following procedure while the display is blinking.

Please execute operation in stopped condition.

1 Press the QUICK MOVE key.

① Press the QUICK MOVE key.



② Set it.



To abort operation, press the QUICK MOVE key again.

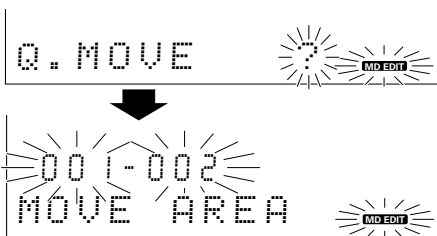

2 Select the range of tracks to be reordered.

① Select the first track in the reordered range.

To decrease track No. To increase track No.

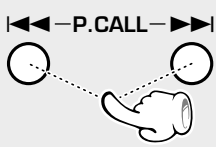

② Set the reordered range.

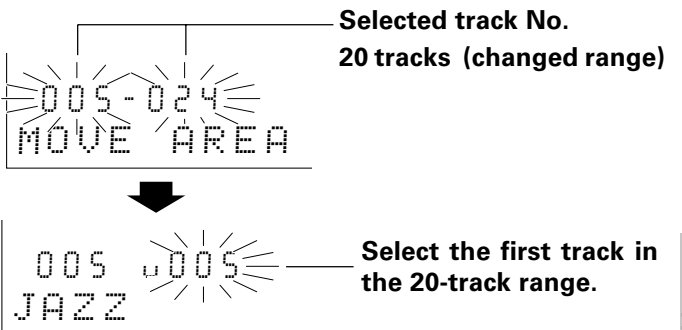
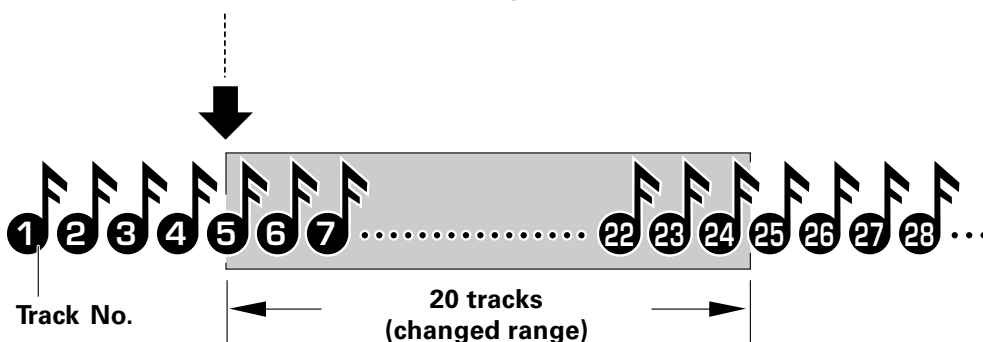



Image of track insertion

Select the first track in the 20-track range.



The procedure is continued on the next page.

3 Select tracks numbers in the desired order.

1 Select a track number.

To decrease track No. To increase track No.

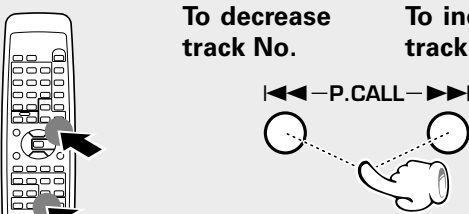

2 Set it.



(Repeat steps **1** and **2** until all tracks have been arranged in the desired order.)

Moving the present track No. 7 to track No. 5

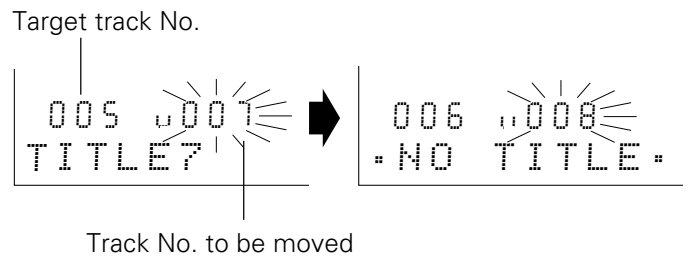

- Pressing the ◀▶ key allows to check the current order of tracks.

4 Execute the track move operation.



ENTER

COMPLETE !

- It takes a while until the execution completes.
- Do not press the ▲ (eject) key or I/⏻ key while the "COMPLETE !" display is blinking. Otherwise the track reordering operation may be suspended in the middle.

5 After editing, eject and remove the mini disc.

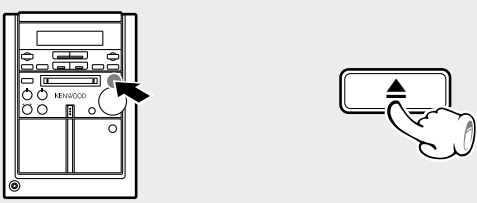

The MD operates on the basis of the information read from the disk into memory. Always remove the minidisc after title input or editing.

"WRITING" displayed during the minidisc ejection operation indicates that the data associated with recording or editing is being written on the disc. Do not apply vibration or shock to the unit while this message is displayed.

Moving a single track (TRACK MOVE)

This procedure shows you how to select and move (insert) a track to the track number you desire. The surrounding tracks are renumbered automatically.

Repeating this procedure lets you arrange the tracks in the order you desire.

Perform the operations in the following procedure while the display is blinking.

Please execute operation in stopped condition.

1 Select "MOVE ?".

1 Select "MOVE ?".



2 Set it.



Each press switches the operation.

- ① MOVE ?
- ② COMBINE ?
- ③ ALL ERASE ?
- ④ Editing cancelled

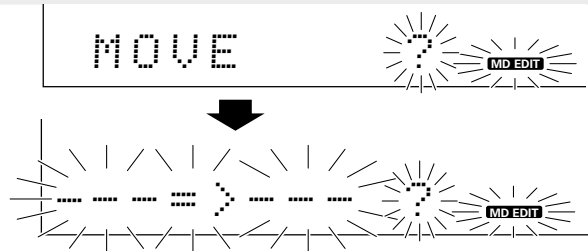

2 Select the track to be moved.

1 Select a track number.

To decrease track No. To increase track No.

← P.CALL →

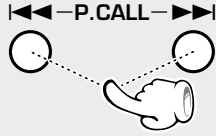

2 Set it.

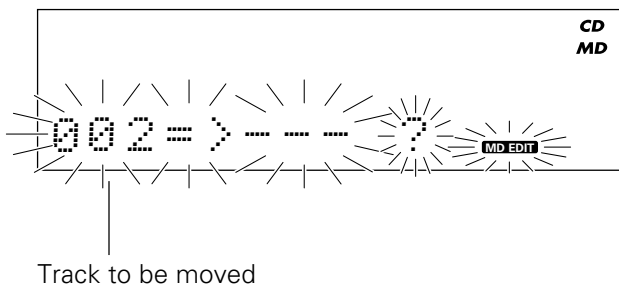
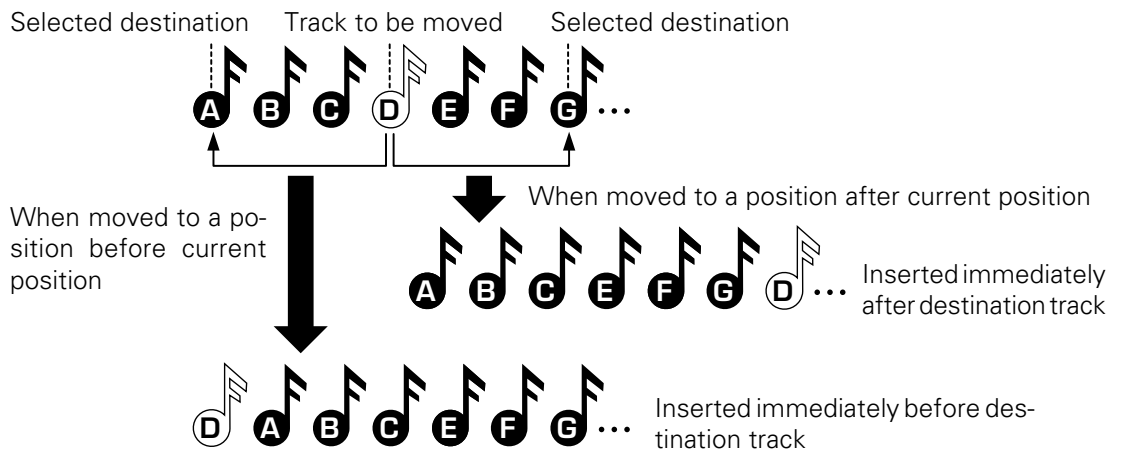



Image of track moving



The procedure is continued on the next page.

3 Select the moving destination track.

1 Select a track number.

To decrease track No. To increase track No.

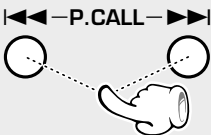

2 Set it.

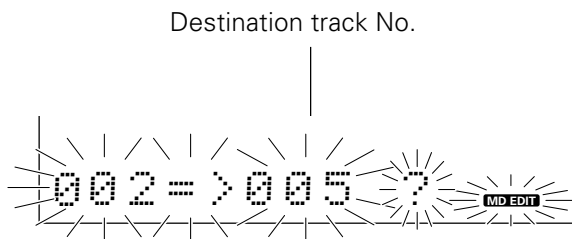
4 Execute the track move operation.

5 After editing, eject and remove the mini disc.

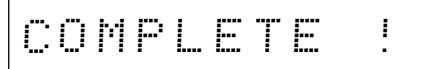

The MD operates on the basis of the information read from the disk into memory. Always remove the minidisc after title input or editing.

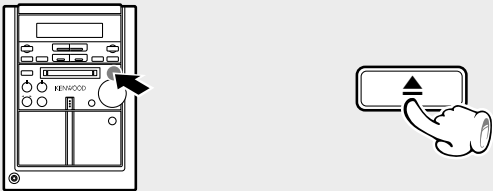
“WRITING” displayed during the minidisc ejection operation indicates that the data associated with recording or editing is being written on the disc. Do not apply vibration or shock to the unit while this message is displayed.

Dividing a track (TRACK DIVIDE)

Use the following procedure to divide a track into two by inserting a track number in its middle. For example, by inserting an additional track number before the passage you are specially fond of, it is easy to skip to there when you play the disc later. Note that the track numbers of the tracks located after the divided track are automatically incremented.

Always remove the minidisc after title input or editing.

“WRITING” displayed during the minidisc ejection operation indicates that the data associated with recording or editing is being written on the disc. Do not apply vibration or shock to the unit while this message is displayed.

Perform the operations in the following procedure while the display is blinking.

1 Play the track to be divided.

• This operation is also possible during pause.

2 Press the TRACK EDIT key at the desired position.

1 Select “DIVIDE ?”.

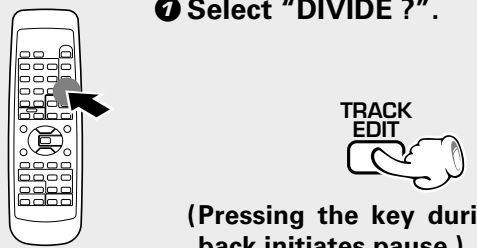

TRACK EDIT

(Pressing the key during playback initiates pause.)

2 Set it.

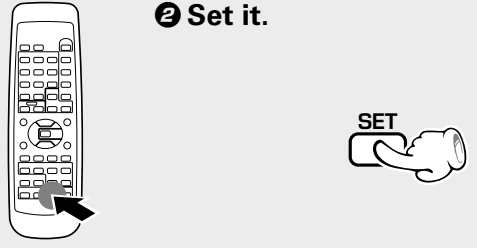

SET

Each press switches the operation.

- ① DIVIDE ?
- ② COMBINE ?
- ③ ERASE ?
- ④ Editing cancelled

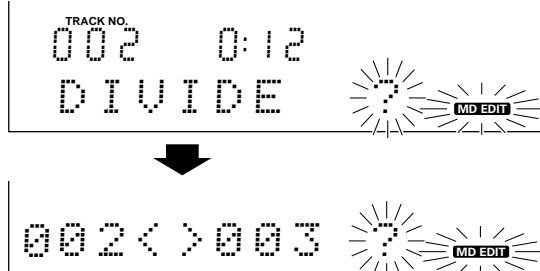

3 Execute the track divide operation.

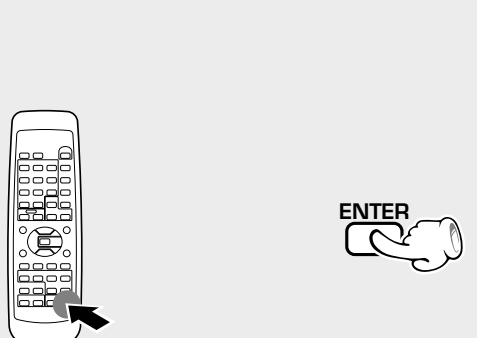

ENTER

(Up to 255 track numbers can be inserted additionally by repeating **1** to **2** for each of them.)

Should be approx. 2 sec. or longer.

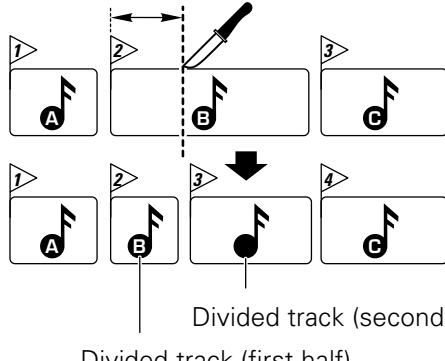

Track number is incremented.

COMPLETE !

- There is no blank space left between the two tracks.
- When the track to be split has a title, the two tracks will have the same title.

4 After editing, eject and remove the mini disc.

Combining two tracks (TRACK COMBINE)

Use the following procedure to combine two tracks into one by deleting a track number. This operation allows to connect several tracks or a piece of music divided into several parts. After this operation, the track numbers of tracks located after the combined tracks are decreased automatically.

Always remove the minidisc after title input or editing.

"WRITING" displayed during the minidisc ejection operation indicates that the data associated with recording or editing is being written on the disc. Do not apply vibration or shock to the unit while this message is displayed.

Perform the operations in the following procedure while the display is blinking.

1 Select "COMBINE ?".



"COMBINE ?" cannot be selected if the track being played is the first track on the disc.

1 Select "COMBINE ?".



2 Set it.



(If you combine tracks during playback, go to step 2.)

When pressed in stop mode

Each press switches the operation.

- 1 MOVE ?
- 2 COMBINE ?
- 3 ALL ERASE ?
- 4 Editing cancelled



When pressed in play mode

- 1 DIVIDE ?
- 2 COMBINE ?
- 3 ERASE ?
- 4 Editing cancelled



- To combine two tracks during playback, press the **TRACK EDIT** key while the second track is being played.

2 Select the track to be combined.

1 Select the track number.

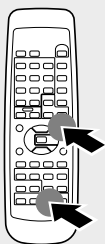

To decrease track No. To increase track No.

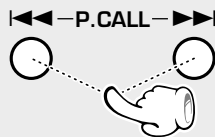

2 Set it.



Connecting tracks 2 and 3.



Should be approx. 2 sec. or longer.

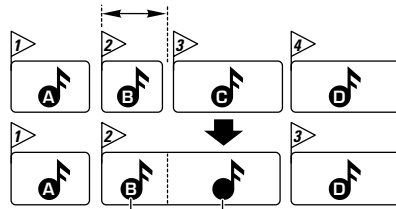

Track No. is adjusted.

Track No. and title of the first track are left.

Track No. and title of the second track are cleared.

3 Execute the track combine operation.



COMPLETE !

4 After editing, eject and remove the mini disc.

Erasing a single track (TRACK ERASE) or erasing all tracks on a disc (ALL ERASE)

TRACK ERASE

During playback, it is possible to erase only the track being played. The track numbers of the tracks after the erased track will be adjusted. Be careful in using this operation because a track cannot be recovered once it has been erased.

ALL ERASE

During stop, all tracks can be erased. Be careful in using this operation because the tracks cannot be recovered once the entire minidisc has been erased.

Perform the operations in the following procedure while the display is blinking.

1 Make the preparations.

To erase one track (TRACK ERASE)

① Start playback.

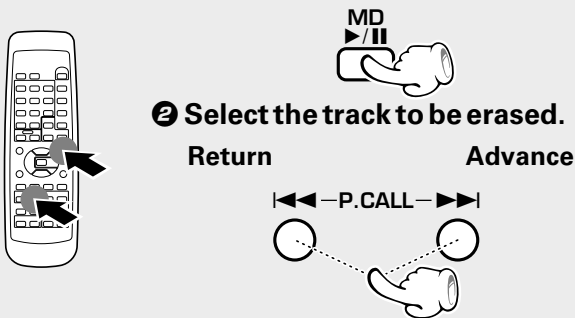

② Select the track to be erased.

Return Advance

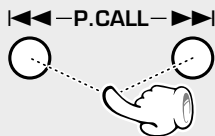

To erase all tracks (ALL ERASE)

(Enter stop status)



2 Select the ERASE mode.

Select "ERASE ?".

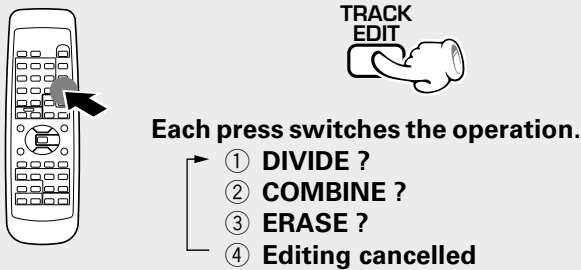

Each press switches the operation.

- ① DIVIDE ?
- ② COMBINE ?
- ③ ERASE ?
- ④ Editing cancelled



① Select "ALL ERASE ?".

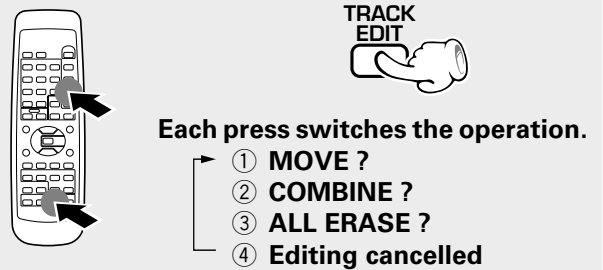

Each press switches the operation.

- ① MOVE ?
- ② COMBINE ?
- ③ ALL ERASE ?
- ④ Editing cancelled

② Set it.



3 Execute the erase operation.

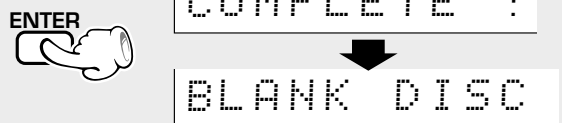

• The track is erased (together with the track title).

• All tracks on a disc are erased (together with the disc title).

The procedure is continued on the next page.

The MD operates on the basis of the information read from the disk into memory. Always remove the minidisc after title input or editing.

“WRITING” displayed during the minidisc ejection operation indicates that the data associated with recording or editing is being written on the disc. Do not apply vibration or shock to the unit while this message is displayed.

4 After editing, eject and remove the mini disc.

Image of erasing one track (TRACK ERASE)

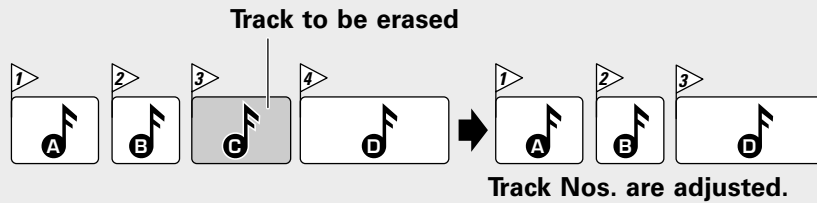

Erasing a part of a track

- ① Turn the part to be erased into one track by using the TRACK DIVIDE function.
- ② Erase it by using the TRACK ERASE function.

Use the following procedure to erase the desired part of a track.

- ① Turn the part to be erased into one track.



Use the TRACK DIVIDE function to turn the part you want to erase into one track.

TRACK DIVIDE → 57

- ② Erase the part to be erased.



Use the TRACK ERASE function to erase the “track” (part you want to erase) made in step ①.

TRACK ERASE → 59

Should be approx. 2 sec. or longer.

Should be approx. 2 sec. or longer.

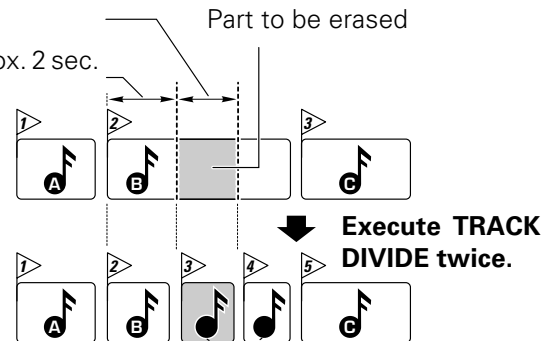

The part divided with TRACK DIVIDE becomes one “track”.

- If it is required to erase only the first or second half of a track, only one TRACK DIVIDE operation is enough.

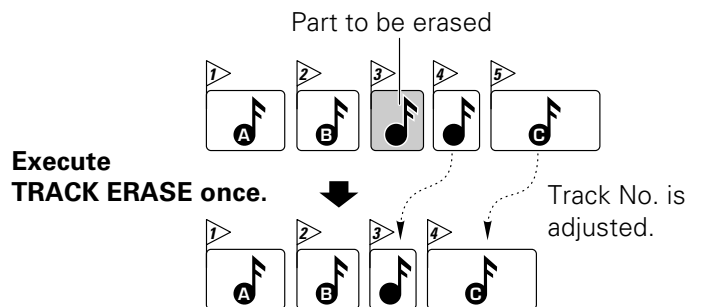

The space left after erasing is filled by subsequent tracks which move along.

Tone adjustment

The lowest and highest frequency bands can be adjusted independently. (Remote control only)

① Select the frequency band.



(Go to step ② within 5 seconds.)

② Adjust.

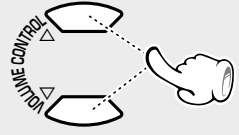

(To adjust the other frequency band, repeat steps ① and ② for it.)

Each press switches the operation.

- ① "BASS" (low frequency) adjustment
- ② "TREBLE" (high frequency) adjustment
- ③ Normal mode

- The levels of both "BASS" and "TREBLE" can be adjusted in 2 steps in the range between -8 and +8.
- Adjusting the tone while the "LOUD" or "EX.BASS" indicator is lit turns it off and cancels the sound enhancement mode.

Balance adjustment (Adjust for the desired left / right balance.)

Adjusts the balance of left and right volume. (Main unit operation only)

1 Select "BALANCE ?".

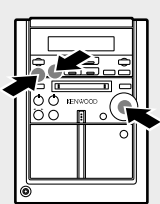

(Press the "set/demo" key while the "?" mark is blinking.)

Turning the knob switches the function as shown in the character information display.

- TAPE RVS. ?
- REC MODE ?
- A. MEMORY ?
- (Only when the TUNER input is selected)
- AUX LEVEL ?
- (Only when the AUX input is selected)
- BALANCE ?**
- TIMER SET ?
- A.P.S. SET ?

2 Adjust.

①

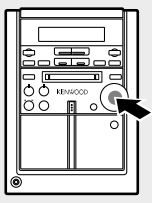

The right volume is decreased. **The left volume is decreased.**

② Set it.

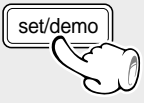
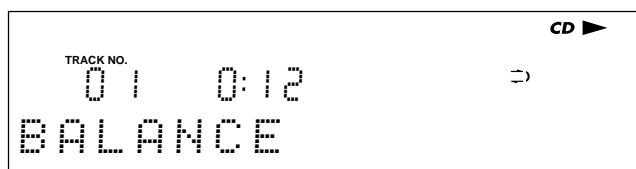
Adjusting the AUX Input Level

This adjusts the input level for the external equipment (video deck etc.) connected to the AUX input terminal. Adjust so that the volume of the AUX input source sounds at an equivalent level to the CD or MD. (Main unit operation only)

1 Select AUX (external input).

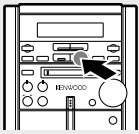

① Select AUX (external input).

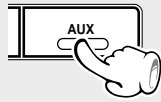

② Play the connected equipment.

2 Select "AUX LEVEL ?".

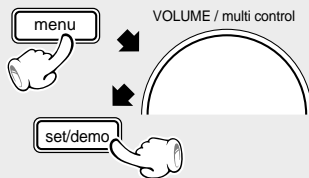

(Press the "set/demo" key while the "?" mark is blinking.)

Turning the knob switches the function as shown in the character information display.

TAPE RVS.	?
REC MODE	?
A. MEMORY	?
(Only when the TUNER input is selected)	
AUX LEVEL	?
(Only when the AUX input is selected)	
BALANCE	?
TIMER SET	?
A.P.S. SET	?

3 Adjust.

① Adjust the input level.

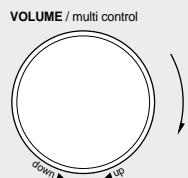
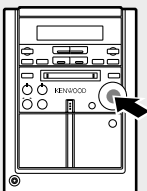

The level decreases.

The level increases.

② Set it



INPUT +2

Set level (display for about 5 sec)

- Adjust the input level while "INPUT" is displayed.
- Adjustment is possible over the range from -6 to +3.

1 Activate the clock adjustment mode.

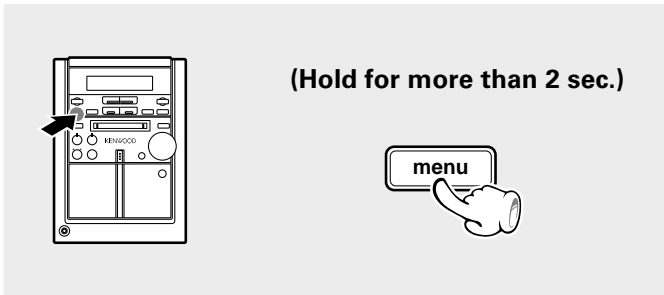

- The "CLOCK" display starts to blink during time setting.

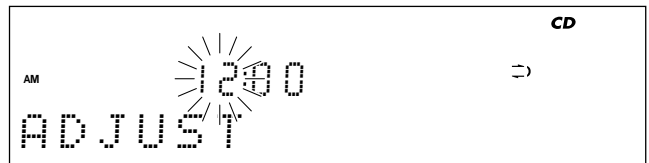

- The time display starts to blink.

2 Enter the figure of hour.

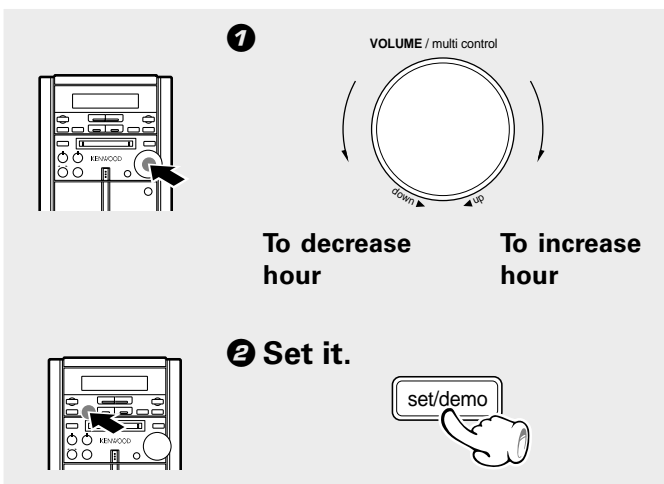

Example: Adjustment to 8:07

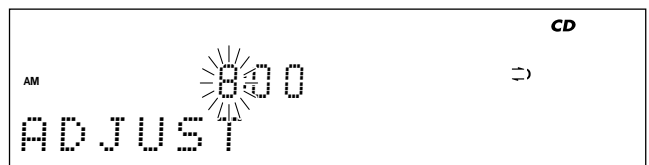

- The time of the day is represented in 12-hour AM/PM method.
- Press the "set/demo" key. The hour is entered and the minute display starts to blink.

3 Enter the figure of minute.

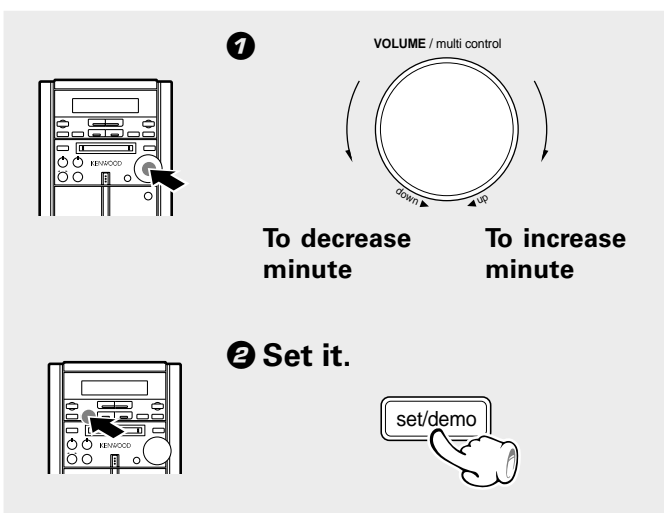

Example: Adjustment to 8:07

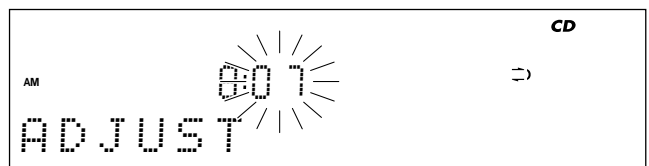

- If you make a mistake, restart from the beginning.
- To adjust correct time, press the "set/demo" key at the same moment as a time announcement.
- After a power failure or the power cord has been unplugged then plugged in again, it is required to set the time again.
- When the time of day has been set by pressing the "set/demo" key, the display shows "COMPLETE !".

Operate easy To use Timer (O.T.T.)

Playback of the selected input source starts at the specified time, and the unit is switched off after one hour. This timer operates only once directly after setting.

Timer playback, timer recording (PROG.1, PROG.2)

With each of the two timer programs, a selected source can be played (or radio broadcast can be recorded) in the previously set time period.

All timer playback (PROG.1, PROG.2)

The volume increases gradually after start of timer playback.

Sleep timer (SLEEP)

The unit is turned OFF automatically after the specified period has elapsed.

Connect the related equipment under reference to "System connection".



Setting the O.T.T.

Timer playback is possible simply by setting the time.

The source selected last before the unit was switched off will be played. One hour after start of timer playback, the unit will be switched off automatically.

1 Select the source to be played.



2 Select "TIMER SET ?" .

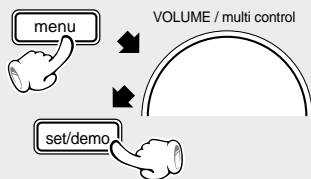

(Press the "set/demo" key while the "?" mark is blinking.)

3 Select "O.T.T. SET ?" .



4 Set the ON time.

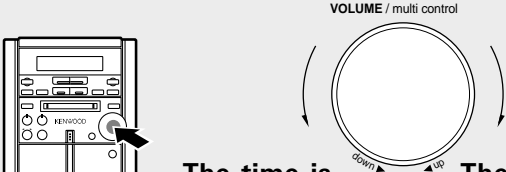

The time is returned.

The time is advanced.

5 Set it.



Turning the knob switches the function as shown in the character information display.

TAPE RVS.	?
REC MODE	?
A. MEMORY	?
(Only when the TUNER input is selected)	
AUX LEVEL	?
(Only when the AUX input is selected)	
BALANCE	?
TIMER SET	?
A.P.S. SET	?

Turning the knob switches the function as shown in the character information display.

1	O.T.T. SET	?
2	PROG. 1 SET	?
3	PROG. 2 SET	?

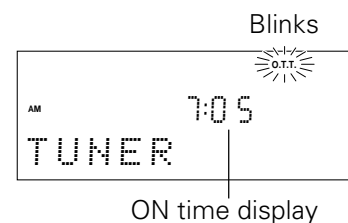

- The ON time can be set in steps of 5 minutes.
- When the O.T.T. has been set by pressing the "set/demo" key, the display shows "COMPLETE !".

To execute O.T.T.

Perform steps **1** and **2** in the procedure in "Activating or deactivating the O.T.T. or program timer execution".

Setting the Program Timer

Two 24-hour timer systems (PROG.1, PROG.2) (which can be used every day) are available. In each of PROG.1 and PROG.2, the timer data including the operating period and played contents can be set and selected to be activated or not as required.

1 Make preparations for the play (recording).

To listen to CD

Insert a disc.
(Program playback is not possible.)

To listen to MD

Load a disc.
(Program playback is not possible.)

To listen to tape

Set a tape into.

To listen to radio

The station should be preset prior to the above. → 29

Playing the auxiliary input source

Make timer setting of the component connected to the AUX input jacks.

For recording

Make preparations for recording.

MD → 30

TAPE → 32

- Timer reservation is possible for the two types PROG.1 and PROG. 2 at the same time.
- Please make reservations with an interval of at least one minute, so that the operation times of PROG. 1 and PROG. 2 do not overlap.

2 Adjust the listening volume.

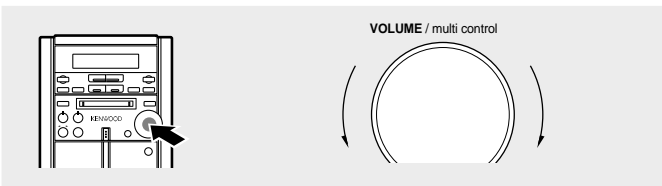

- When the power is switched on by the timer for recording, MUTE automatically becomes ON.

3 Select a program No.

① Select "TIMER SET ?".

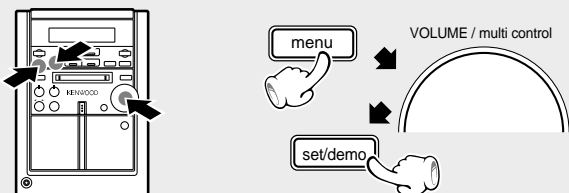

(Press the "set/demo" key while the "?" mark is blinking.)

② Select "PROG. 1 SET ?" or "PROG. 2 SET ?".

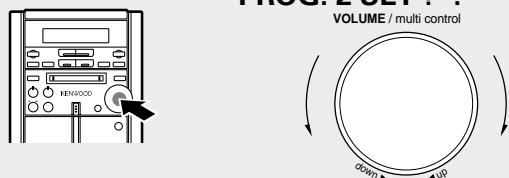

③ Set it.



(Press during display of the program contents.)

Turning the knob switches the function as shown in the character information display.

TAPE RVS.	?
REC MODE	?
A. MEMORY	?
(Only when the TUNER input is selected)	
AUX LEVEL	?
(Only when the AUX input is selected)	
BALANCE	?
TIMER SET	?
A.P.S. SET	?

Turning the knob switches the function as shown in the character information display.

① O.T.T. SET	?
② PROG. 1 SET	?
③ PROG. 2 SET	?

- The selected program No. lights.
- If a program No. under which a timer program has already been reserved, it is replaced by the new timer program.
- The previously set contents are displayed. (If you do not want to change them, simply press the "set/demo" key.)

4 Set the ON time then the OFF time.

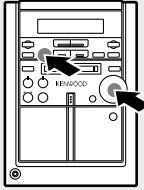

1 Adjust the time.

The time is returned. The time is advanced.

VOLUME / multi control

2 Set it.

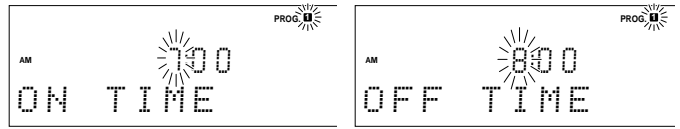
- For each of the ON time and OFF time, enter the figure of "hour" by performing steps **1** and **2** then enter the figure of "minute" in the same manner.
- If you make a mistake, restart from step **3**.

5 Make the desired reservation.

For timer playback or AI timer playback

1 Select the mode.

(1) Select "PLAY" or "AI PLAY".

(2) Enter it.

VOLUME / multi control



2 Select the input source.

(1) Select the source to be played.

(2) Enter it.

VOLUME / multi control



3 Select the broadcast station (only when TUNER is selected above).

(1) Select the preset station No.

(2) Enter it.

VOLUME / multi control



① **PLAY** Timer play

② **REC**

③ **AI PLAY** Timer play with gradually increasing volume

① **TUNER** Broadcasts

② **CD**

③ **MD**

④ **TAPE**

⑤ **AUX** External input (video, etc.)

- When the O.T.T. has been set by pressing the "set/demo" key, the display shows "COMPLETE!".

For timer recording

1 Select the mode.

(1) Select "REC".

① **PLAY**

② **REC**

③ **AI PLAY**

(2) Enter it.

VOLUME / multi control



2 Select the input source.

(1) Select what is to be recorded.

① **TUNER** Broadcasts

② **AUX** External input

(2) Enter it.

VOLUME / multi control



3 Select the broadcast station (only when TUNER is selected above).

(1) Select the preset station No.

(2) Enter it.

VOLUME / multi control



4 Select the broadcast station (only when TUNER is selected above).

(1) Select.

① **MD REC**

② **TAPE REC**

(2) Enter it.

VOLUME / multi control



- When the O.T.T. has been set by pressing the "set/demo" key, the display shows "COMPLETE!".

To execute program timer

Perform steps **1** and **2** in the procedure in "Activating or deactivating the O.T.T. or program timer execution".

Activating or deactivating the O.T.T. or program timer execution

1 Select the timer program No. to be used. (Remote control unit only)

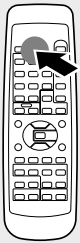

Each press of the key switches the program numbers as follows.

- ① O.T.T. Executes O.T.T. only.
- ② PROG.1 Execution of program 1 only.
- ③ PROG.2 Execution of program 2 only.
- ④ PROG.1, 2.. Execution of programs 1 and 2.
- ⑤ Off Timer off.

- The selected program No. lights.
- The timer will not function unless a program No. is selected.

2 Put the unit in standby mode.

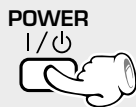

- The standby/timer indicator lights in orange in standby mode.

To set the same timer program again

Press so that the desired PROG. indicators lights.

Press while power is ON.

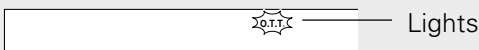

- Be sure to load a disc or tape and adjust the listening volume.

When timer operation is not required

Press so that all PROG. indicators are OFF.

Press while power is ON.

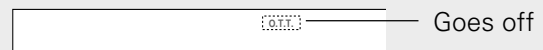

- The reservation contents are held in memory.



To check or modify the reservation contents, restart the timer reservation from the beginning.

Sleep timer (SLEEP)

Set the number of minutes after which the unit is to be turned OFF.

Set the time.

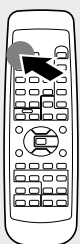

- The unit is turned OFF automatically after the set time has elapsed.
- Each press increases the timer period by 10 minutes. The sleep timer can be set up to 90 minutes.

10→20→30...70→80→90→Cancel→10→20...

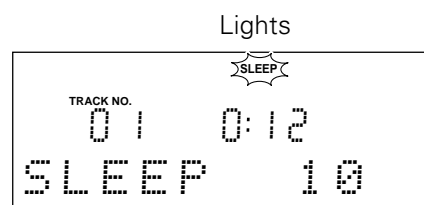

To cancel

Turn the unit OFF or press the SLEEP key until the sleep time is cancelled.

Maintenance

Cleaning the head section

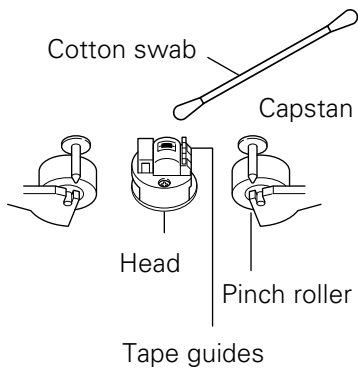

Cleaning the heads and peripheral components

For maintaining the best condition of the deck and for longer service life, always keep the heads (recording / playback / erase), capstan and pinch roller clean.

To clean them, perform the following:

1. Open the cassette holder.
2. Using a cotton swab dipped in alcohol, clean the head (recording / playback / erase), capstan and pinch roller carefully.

Demagnetizing the head

When the recording / playback head is magnetized, the sound quality will deteriorate. In such a case, demagnetize the head using a commercially available demagnetizer (head eraser).



There are precisely aligned parts around the heads, including the tape guides. When cleaning, pay special attention so as not to apply shock to them.

Maintenance of the Set

When the front panel, the case, etc. becomes dirty, wipe with a soft, dry cloth. Do not use thinner, alcohol, etc., as these can cause discoloration.

In regard to contact cleaners

Do not use contact cleaners because it could cause a malfunction. Be specially careful not to use contact cleaners containing oil, for they may deform the plastic component.

Reference

Caution on condensation

Condensation (of dew) may occur inside the unit when there is a great difference in temperature between this unit and the outside.

This unit may not function properly if condensation occurs. In this case, leave the unit for a few hours with the power left ON, and restart the operation after the condensation has dried up.

Be specially cautious against condensation in a following circumstance:

When this unit is carried from a place to another across a large difference in temperature, when the humidity in the room where this unit is installed increases, etc.

Note related to transportation and movement

Before transporting or moving this unit, carry out the following operations.

- ❶ Remove the CD or MD from the unit.
- ❷ Press the ►/|| key of the MD.

MD NO DISC

- ❸ Press the ►/|| key of the CD.
- ❹ Wait for some time and verify that the display becomes as shown in the figure.

CD NO DISC

- ❺ Wait a few seconds and turn the unit OFF.

Memory backup function

<p>Stored contents which are cleared immediately when power plug is unplugged from power outlet</p>	<p>Clock display MD recorder section → </p>
<p>Stored contents which are cleared in at least a day after power plug is unplugged from power outlet</p>	<p>Amplifier section "on/standby" status (ON or STANDBY) Last input selection Volume control value Tone control levels AUX input level Balance setting Tuner section Receiving band Frequency Preset stations Auto/mono setting Program timer setting contents Cassette deck unit Transport direction tape EQ. Reverse mode</p>

WARNING NOTICE:

IN MOST CASES IT IS AN INFRINGEMENT OF COPYRIGHT TO MAKE COPIES OF TAPES OR DISCS WITHOUT THE PERMISSION OF THE COPYRIGHT OWNERS. ANYONE WISHING TO COPY COMMERCIALY AVAILABLE TAPES OR DISC SHOULD CONTACT THE MECHANICAL COPYRIGHT PROTECTION SOCIETY LIMITED OR THE PERFORMING RIGHTS SOCIETY LIMITED.

What seems to be a malfunction is not always so. Before calling for service, check the following table according to the symptom of your trouble.

Operation to reset

The microcomputer may fall into malfunction (impossibility to operate, erroneous display, etc.) when the power cord is unplugged while unit is ON or due to an external factor. In this case, execute the following procedure to reset the microcomputer and return it to normal condition.

- Please note that resetting the microcomputer clears the contents stored in and it returns to condition when it left the factory.

Unplug the power cord from the power outlet then, while holding the "set/demo" key depressed, plug the power cord again.

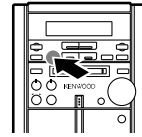

Amplifier section/Speakers

Symptom	Cause	Remedy
Sound is not produced.	<ul style="list-style-type: none"> ● The speaker cords are disconnected. ● The volume control is set to the minimum position. ● The MUTE key of remote control unit is switched ON. ● The headphone plug is inserted into the jack. 	<ul style="list-style-type: none"> ● Connect properly referring to "System connections". → 10 ● Adjust to an required volume. ● Switch MUTE OFF. → 19 ● Unplug the headphone plug.
"standby/timer" blinks and no sound is put out.	<ul style="list-style-type: none"> ● The speaker cords are short-circuited. 	<ul style="list-style-type: none"> ● Turn the unit OFF, remove the short-circuit and turn the unit ON again.
No sound from the headphones.	<ul style="list-style-type: none"> ● Imperfect insertion. 	<ul style="list-style-type: none"> ● Insert correctly. → 19
Sound is not produced from the left or right speakers.	<ul style="list-style-type: none"> ● The speaker cords are disconnected. ● The BALANCE is set completely to the left or right channel. 	<ul style="list-style-type: none"> ● Connect properly referring to "System connection". → 10 ● Adjust the optimum left and right balance. → 61



Tuner section

Symptom	Cause	Remedy
The clock display blinks without changing the figures.	<ul style="list-style-type: none"> ● There was a power failure. ● The power cord was unplugged from the outlet. 	<ul style="list-style-type: none"> ● Adjust the present time again. → 63 ● Adjust the present time again.
Timer operation is not possible.	<ul style="list-style-type: none"> ● The present time has not been adjusted or there was a power failure. ● The timer ON time and OFF time have not been set. ● The timer execution was not set up. 	<ul style="list-style-type: none"> ● Adjust the present time referring to "Clock adjustment". → 65 ● Set the timer ON time and OFF time. ● Press the TIMER key to set up the execution.
Radio stations cannot be received.	<ul style="list-style-type: none"> ● The antennas have not been connected. ● A proper broadcasting band has not been selected. ● The frequency of the station to be received is not tuned. 	<ul style="list-style-type: none"> ● Connect antennas. → 10 ● Select a band. → 28 ● Tune to the frequency of the desired station.
Noise interferes.	<ul style="list-style-type: none"> ● Car ignition noise. ● Influence of an electric appliance. ● A TV set is installed near the system. 	<ul style="list-style-type: none"> ● Install the outdoor antenna in an apart position from the road. ● Switch the suspected electric appliance OFF. ● Install the TV or the system at an increased distance between them.
A station has been preset but it cannot be received by pressing the P.CALL key.	<ul style="list-style-type: none"> ● The frequency of the preset station is not tunable. ● The preset memory has been cleared because the power cord has been unplugged for a long period. 	<ul style="list-style-type: none"> ● Preset stations with tunable frequencies. ● Preset stations again. → 29



Symptoms related to MD standard

Symptom	Cause
"DISC FULL" is displayed while the disc still has a remaining recordable time.	<ul style="list-style-type: none"> More than 255 tracks (track No. 256 or more) cannot be recorded. (There may be also cases in which recording is impossible while the track number is less than 256.) In such a case, the REMAIN time display shows "0:00".
The possible recording time does not increase even when a short track is erased.	<ul style="list-style-type: none"> When the remaining time of the entire disc is less than 12 sec, the remaining time indication on the display becomes "0:00". When the total time of the deleted tracks exceeds 12 sec, the display changes to the recordable time. When a short track is deleted on a repeatedly edited disc, the remaining time may not increase.
Tracks can not be connected.	<ul style="list-style-type: none"> Connection of the track resulting from edit processing may not be possible.
The time which has been recorded on the MD and the remaining time do not add up to the maximum recording time (60 or 74 min.).	<ul style="list-style-type: none"> As recording is executed with 2 sec. as the minimum unit, the display time may not coincide.
When search is performed in a track which has been compiled by editing, the sound is sometimes interrupted.	<ul style="list-style-type: none"> This derives from the restriction in the MD system standard and not a malfunction.
The track numbers are not assigned correctly.	<ul style="list-style-type: none"> Depending on the contents of the recorded source (CD etc.), the track numbers may not be assigned correctly.
"READING" is displayed for an abnormally long time.	<ul style="list-style-type: none"> When a new recordable MD (with nothing recorded) is inserted, "READING" is displayed longer than usual.
The time display becomes inaccurate with a monaurally recorded disc.	<ul style="list-style-type: none"> Monaural recording and stereo recording are executed according to different formats. This is not a malfunction.
Input of 1792 title characters is not possible.	<ul style="list-style-type: none"> The title recording area is used in units of 7 characters, so that input of 1792 characters may not be possible.

MD recorder section (other symptoms)

Symptom	Cause	Remedy
Sound is not output even when the play key is pressed.	<ul style="list-style-type: none"> No disc has been loaded. A non-recorded disc has been loaded. 	<ul style="list-style-type: none"> Load a disc. Load a prerecorded disc or playback-only disc. 
Recording is not possible	<ul style="list-style-type: none"> The disc is write-protected. An attempt is made to record digital signal from a source while its digital copy has been prohibited by SCMS. The recording level is too low. (During AUX input operation) A playback-only disc has been loaded. The disc does not have a recordable area. The input selector is set to MD. 	<ul style="list-style-type: none"> Change the position of the write protect tab to the write position or use a recordable disc. Recording is not possible. Adjust the AUX input level. Use a recordable disc. Use another disc. Set the input selector to the source to be recorded.  
Sound is distorted.	<ul style="list-style-type: none"> The recording level has not been adjusted. (During AUX input operation) A disc in which distorted sound has been recorded is played. 	<ul style="list-style-type: none"> Adjust the AUX input level. Record again.
Noise is noticeable.	<ul style="list-style-type: none"> An external noise is induced. 	<ul style="list-style-type: none"> Install the unit at a position apart from an electric appliance or TV set.
The display goes out for a moment after the unit has been turned ON.	<ul style="list-style-type: none"> Switching is operated too quickly. 	<ul style="list-style-type: none"> This is not a malfunction.

MD recorder section (Displayed messages and actions to be taken against them)

Displayed Message	Meaning	Action
NO DISC	<ul style="list-style-type: none"> No disc is placed on the tray. 	<ul style="list-style-type: none"> Load a disc.
CAN'T COPY	<ul style="list-style-type: none"> An attempt is made to record digital signal from a source while its digital copy has been prohibited by SCMS. 	<ul style="list-style-type: none"> Switch to analog recording.
DISC FULL	<ul style="list-style-type: none"> There is no recordable area on the disc. An attempt is made to record a 256th track. 	<ul style="list-style-type: none"> Use another recordable disc. More than 256 tracks cannot be recorded per disc.
TITLE FULL	<ul style="list-style-type: none"> An attempt is made to assign a title with more characters than usable. 	<ul style="list-style-type: none"> Refer to "Total number of title characters". →  50
BLANK DISC	<ul style="list-style-type: none"> The disc does not contain any recordings. 	<ul style="list-style-type: none"> When playback is required, use a recorded disc.
NO TRACKS	<ul style="list-style-type: none"> The disc does not contain any tracks but has a disc title. 	<ul style="list-style-type: none"> The disc can be used for recording without any problem.
READING	<ul style="list-style-type: none"> The TOC *1 data of the disc is being read. 	<ul style="list-style-type: none"> This is a normal operation.
WRITING	<ul style="list-style-type: none"> The data related to editing or recording is being written in the disc. 	<ul style="list-style-type: none"> This is a normal operation.
DISC ERROR	<ul style="list-style-type: none"> The contents of UTOC *2 are abnormal. 	<ul style="list-style-type: none"> Perform "ALL ERASE" operation. If this is not possible, use another disc. →  59
CAN'T EDIT	<ul style="list-style-type: none"> An attempt is made to perform editing beyond the restrictions, for example to erase a track which is too short. 	<ul style="list-style-type: none"> Perform editing following the restrictions.
?(blinking)	<ul style="list-style-type: none"> This is a message for confirming if editing can really be executed. 	<ul style="list-style-type: none"> Press the ENTER key to execute editing.
PROTECTED	<ul style="list-style-type: none"> The minidisc is write-protected. 	<ul style="list-style-type: none"> Cancel the write protection. →  8
PLAY ONLY	<ul style="list-style-type: none"> The minidisc is only for playback. 	<ul style="list-style-type: none"> Insert a minidisc for recording.
UNIT ERROR	<ul style="list-style-type: none"> This indicates some trouble. 	<ul style="list-style-type: none"> Return to normal condition is made by switching the unit off and then on again.

US and foreign patents licensed from Dolby Laboratories Licensing Corporation.

*1 All minidisks contain a Table of Contents (TOC) in addition to sound signals. The TOC is similar to the table of contents in a book and contains information, such as track numbers, track length, and character information, that cannot be rewritten.

*2 In addition to the TOC, minidisks also contain a special User's Table of Contents (UTOC) that contains track number, track length, and character information, that can be rewritten.





Memory Backup for the MD Recorder Section

The contents of the memory are not stored on the disc if the power cord is unplugged.



If there is a power failure or if the power cord is unplugged, the recording or editing information (normally recorded when the minidisc is removed) may be erased or destroyed before it is recorded on the minidisc. Once the information has disappeared, it can not be recovered.

After recording or editing, always remove the minidisc to record the recording or editing information.

CD player section

Symptom	Cause	Remedy
A CD is placed in the player but it cannot be played.	<ul style="list-style-type: none"> ● The disc is placed upside down. ● The disc position is displaced. ● The disc is extremely dirty. ● The disc is scratched. ● Dew is condensed on the optics lens. 	<ul style="list-style-type: none"> ● Place the disc properly, with the label side facing upward. ● Place the disc properly. ● Clean the disc referring to "Disc handling precautions". →  8 ● Try another disc. ● Refer to "Caution on condensation" and remove the condensation by evaporation. →  69
Sound is not produced.	<ul style="list-style-type: none"> ● The disc has not been placed. ● The player is not put to the play mode. ● The disc is extremely dirty. ● The disc is scratched. 	<ul style="list-style-type: none"> ● Place a disc in the CD player. ● Press the ►/ key. ● Clean the disc referring to "Disc handling precautions". →  8 ● Try another disc.
Sound skips.	<ul style="list-style-type: none"> ● The disc is dirty. ● The disc is scratched. ● The player is subject to vibration. 	<ul style="list-style-type: none"> ● Clean the disc referring to "Disc handling precautions". →  8 ● Try another disc. ● Install the unit in a place not subject to vibrations.

Remote control unit

Symptom	Cause	Remedy
Remote control operation is not possible.	<ul style="list-style-type: none"> ● Batteries are exhausted. ● The remote control is too far away from the system, the controlling angle is deviated or there is an obstacle in between. ● The component to be played is not loaded with a CD, MD or cassette tape. 	<ul style="list-style-type: none"> ● Replace with new batteries. →  17 ● Operate the unit inside the remote controllable range. →  17 ● Load a CD, MD or cassette tape in the component to be played.

Cassette deck

Symptom	Cause	Remedy
Sound cannot be produced by pressing the play key.	<ul style="list-style-type: none"> ● The head is dirty. ● The tape is wound too tight due to irregular winding. ● A nonrecorded tape is played. 	<ul style="list-style-type: none"> ● Clean the head referring to "Maintenance". → 68 ● Try another tape. ● Play a recorded tape.
No operation occurs even when an operation key is pressed.	<ul style="list-style-type: none"> ● The cassette holder is not closed completely. ● The operation key is pressed immediately after closing the cassette holder. ● The operation key is pressed in less than 4 seconds after turning the power ON. ● A tape is not inserted in the unit. ● The tape is wound too tight due to irregular winding. ● The tape is fully wound to one of the reels. 	<ul style="list-style-type: none"> ● Close the holder completely. → 26 ● Press operation keys in more than a few seconds after closing the cassette holder. ● Press operation keys after waiting for more than 4 seconds. ● Insert a tape. → 26 ● Try another tape. ● Change the tape transport direction or reverse the tape insertion orientation. → 26
The cassette holders cannot be opened by pressing the "▲ push OPEN" area.	<ul style="list-style-type: none"> ● The key is pressed during recording or playback. ● The microcomputer is malfunctioning due to external noise. 	<ul style="list-style-type: none"> ● Press in stop mode. ● Reset the microcomputer. → 70
Sound is harsh or high frequencies are not reproduced.	<ul style="list-style-type: none"> ● The head is dirty. ● The tape is stretched or shrunk. 	<ul style="list-style-type: none"> ● Clean the head referring to "Maintenance". → 68 ● Try another tape.
Sound is distorted.	<ul style="list-style-type: none"> ● The recording level has not been adjusted. (During AUX input operation) ● The tape being played was recorded with distorted sound. 	<ul style="list-style-type: none"> ● Adjust the AUX input level. ● Try another tape.
Noise is noticeable.	<ul style="list-style-type: none"> ● The tape head is magnetized. ● External noise is induced. ● A tape recorded with Dolby NR ON is played with "tape EQ." off. 	<ul style="list-style-type: none"> ● Demagnetize the head referring to "Maintenance". → 68 ● Install the system at a distance from other electric appliances and TV. ● Set the "tape EQ." to on. → 27
Sound vibrates.	<ul style="list-style-type: none"> ● The capstans or pinch rollers are dirty. ● The tape is wound irregularly. 	<ul style="list-style-type: none"> ● Clean the head referring to "Maintenance". → 68 ● Wind the tape again by fast forwarding, rewinding or playing from an end to the other. → 27
Recording cannot be started by pressing the record key.	<ul style="list-style-type: none"> ● The recording protect tab of the cassette has been broken. ● The cassette holder is not closed completely. ● The TAPE input is selected. ● The tape is fully wound to one of the reels. 	<ul style="list-style-type: none"> ● Use a cassette with an unbroken recording protect tab or block the hole. → 9 ● Close the holder completely. → 26 ● Set the input selector to the source to be recorded. → 33 ● Change the tape transport direction or reverse the tape insertion orientation. → 26

Main unit

[[Amplifier section]

Effective output power during STEREO operation
1 kHz, 10 % T.H.D., at 6 Ω 15 W + 15 W
Rated output power during STEREO operation
Other countries
1 kHz, 0.7 % T.H.D., at 6 Ω 12 W + 12 W
Frequency response
AUX 20 Hz~20 kHz (0 dB ~ -3dB)

[Tuner section]

FM tuner section
Tuning frequency range 87.5 MHz ~ 108 MHz

MW (AM) tuner section

Tuning frequency range
9 kHz step 531 kHz ~ 1,602 kHz
10 kHz step 530 kHz ~ 1,610 kHz

[MD recorder section]

Laser Semiconductor laser
Recording method Field modulation overwrite method
D/A Conversion 1 Bit
Wow & flutter Less than unmeasurable limit

[CD player section]

Laser Semiconductor laser
D/A Conversion 1 Bit
Frequency response 20 Hz~20 kHz
Wow and flutter Less than unmeasurable limit

[Cassette deck section]

Track 4-track, 2-channel stereo
Recording system AC bias system
(Frequency: 65 kHz)

Heads

Playback / recording head 1
Erasing head 1
Motors 1
Wow and flutter 0.2 % (W.R.M.S.)
Fast winding time Approx. 100 seconds
(C-60 tape)

[General]

Power consumption 36 W
Dimensions W : 180 mm
H : 257 mm
D : 275 mm
Weight (net) 5.1 kg

Speakers

Enclosure Book shelf type, magnetically shielded
Speaker configuration
Woofers 100 mm, cone type
Tweeter 50 mm, cone type
Impedance 6 Ω
Maximum input level 20 W
Dimensions W : 150 mm
H : 255 mm
D : 240 mm
Weight (net) 2.4 kg(1 piece)



KENWOOD follows a policy of continuous advancements in development. For this reason specifications may be changed without notice.

- Sufficient performance may not be exhibited at extremely cold locations (where water freezes).

KENWOOD

For your records

Record the serial number, found on the back of the unit, in the spaces designated on the warranty card, and in the space provided below. Refer to the model and serial numbers whenever you call upon your dealer for information or service on this product.

Model _____ Serial Number _____