

# JVC

# SERVICE MANUAL

## MINIDISC RECORDER

# XM-EX90

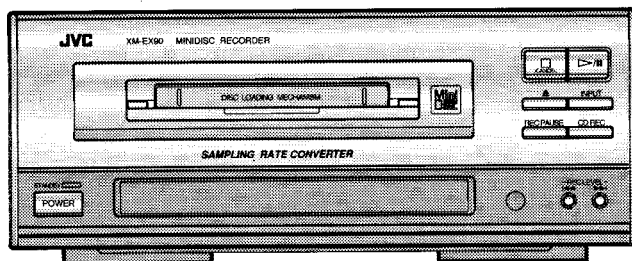
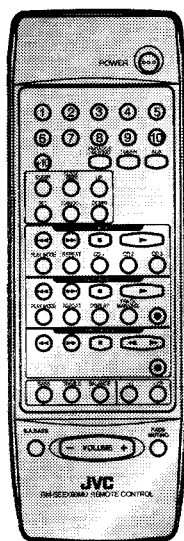

### Area Suffix

B	-----	U.K.
C	-----	Canada
E	-----	Continental Europe
J	-----	U.S.A.
EE	-----	Eastern Europe
EN	-----	Northern Europe
UB	-----	Hong Kong
UF	-----	China
US	-----	Singapore
UT	-----	Taiwan
U	-----	Other Areas

## Contents

Safety Precautions	-----	1-2	Description of Major ICs	-----	2-15
Importance Admistering point on the safety	-----	1-3	Block Diagrams	-----	2-16
Important for Laser Products	-----	1-4	Schematic Diagrams	-----	2-21
Instructions	-----	1-5~34	Printed Circuit Boards	-----	2-24
Location of Main Part	-----	2-1	Parts List	-----	3-1
Removal of Main parts	-----	2-3			
Main Adjustment	-----	2-7			
Flow of Functional Operation					
Until TOC read	-----	2-9			

## Safety Precautions

1. This design of this product contains special hardware and many circuits and components specially for safety purposes. For continued protection, no changes should be made to the original design unless authorized in writing by the manufacturer. Replacement parts must be identical to those used in the original circuits. Services should be performed by qualified personnel only.
2. Alterations of the design or circuitry of the product should not be made. Any design alterations of the product should not be made. Any design alterations or additions will void the manufacturer's warranty and will further relieve the manufacturer of responsibility for personal injury or property damage resulting therefrom.
3. Many electrical and mechanical parts in the products have special safety-related characteristics. These characteristics are often not evident from visual inspection nor can the protection afforded by them necessarily be obtained by using replacement components rated for higher voltage, wattage, etc. Replacement parts which have these special safety characteristics are identified in the Parts List of Service Manual. Electrical components having such features are identified by shading on the schematics and by ( $\triangle$ ) on the Parts List in the Service Manual. The use of a substitute replacement which does not have the same safety characteristics as the recommended replacement parts shown in the Parts List of Service Manual may create shock, fire, or other hazards.
4. The leads in the products are routed and dressed with ties, clamps, tubings, barriers and the like to be separated from live parts, high temperature parts, moving parts and/or sharp edges for the prevention of electric shock and fire hazard. When service is required, the original lead routing and dress should be observed, and it should be confirmed that they have been returned to normal, after re-assembling.
5. Leakage current check (Electrical shock hazard testing)  
After re-assembling the product, always perform an isolation check on the exposed metal parts of the product (antenna terminals, knobs, metal cabinet, screw heads, headphone jack, control shafts, etc.) to be sure the product is safe to operate without danger of electrical shock. Do not use a line isolation transformer during this check.
  - Plug the AC line cord directly into the AC outlet. Using a "Leakage Current Tester", measure the leakage current from each exposed metal parts of the cabinet, particularly any exposed metal part having a return path to the chassis, to a known good earth ground. Any leakage current must not exceed 0.5mA AC (r.m.s.)

- Alternate check method

Plug the AC line cord directly into the AC outlet. Use an AC voltmeter having, 1,000 ohms per volt or more sensitivity in the following manner. Connect a 1,500 $\Omega$  10W resistor paralleled by a 0.15 $\mu$ F AC-type capacitor between an exposed metal part and a known good earth ground.

Measure the AC voltage across the resistor with the AC voltmeter.

Move the resistor connection to each exposed metal part, particularly any exposed metal part having a return path to the chassis, and measure the AC voltage across the resistor. Now reverse the plug in the AC outlet and repeat each measurement voltage measured any must not exceed 0.75 V AC (r.m.s.). This corresponds to 0.5 mA AC (r.m.s.).

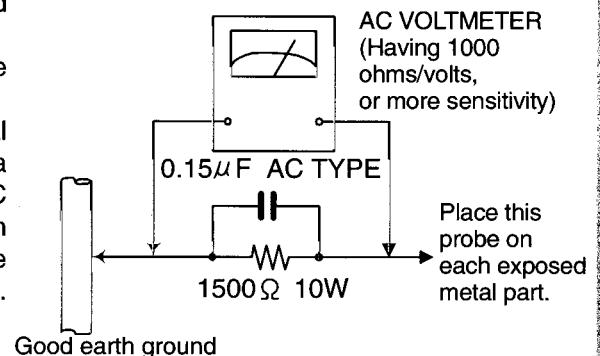

## Warning

1. This equipment has been designed and manufactured to meet international safety standards.
2. It is the legal responsibility of the repairer to ensure that these safety standards are maintained.
3. Repairs must be made in accordance with the relevant safety standards.
4. It is essential that safety critical components are replaced by approved parts.
5. If mains voltage selector is provided, check setting for local voltage.

**CAUTION** Burrs formed during molding may be left over on some parts of the chassis. Therefore, pay attention to such burrs in the case of performing repair of this system.

■ Important administration points regarding safety

- 1. Power transformer making number QQT0177-003 ( E/EN/B/EE version)
- Power transformer making number QQT0177-004 ( U/US/UT/UF/UB version)
- Power transformer making number 71E154HD ( J version)
- power transformer making number QQT0177-002 ( C version)

The torque of the screw driver for the power transformer must be controlled.

- 2. Concerning the AC socket . the next marking must be confirmed and to avoid print circuit board pattern damage, the AC socket must not float from print circuit board. Marking number II14
- 3. Concerning the primary terminal and the adjacent secondary terminal on the print circuit board to provide proper creeping and spatial distance, solder must not protrude from soldering round.
- 4. Wire must be clamped or secured at the location shown in the figure so that the wire do not touch to live parts , moving parts, hot parts or shap edges.
- 5. Following parts are controlled as the heated parts, confirm that the flammable parts are lifted up , the parts in ( ) must be controlled.  
 Diode: D141,D142,D161  
 Transistor:Q142,Q131  
 Resistor: R127,R111,R112,R163,R145,R115,R116  
 Heat sink:H001
- 6. The barrier must be attached on the power supply board.

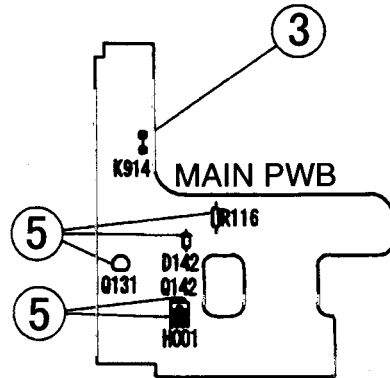
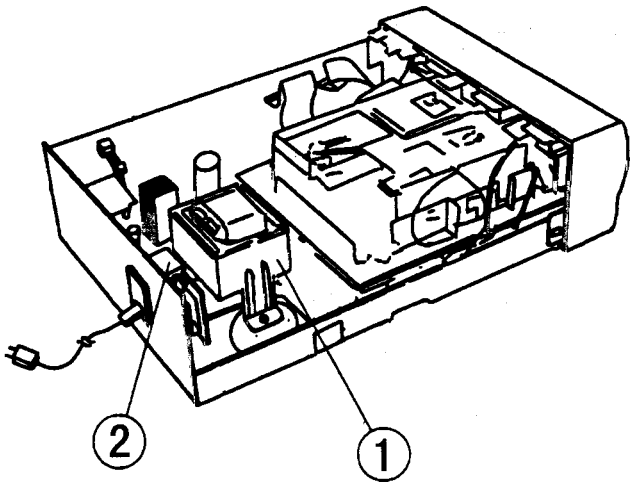

# Important for Laser Products

**1.CLASS 1 LASER PRODUCT**

**2.DANGER :** Invisible laser radiation when open and interlock failed or defeated. Avoid direct exposure to beam.

**3.CAUTION :** There are no serviceable parts inside the Laser Unit. Do not disassemble the Laser Unit. Replace the complete Laser Unit if it malfunctions.

**4.CAUTION :** The compact disc player uses invisible laserradiation and is equipped with safety switches which prevent emission of radiation when the drawer is open and the safety interlocks have failed or are defeated. It is dangerous to defeat the safety switches.

**5.CAUTION :** If safety switches malfunction, the laser is able to function.

**6.CAUTION :** Use of controls, adjustments or performance of procedures other than those specified herein may result in hazardous radiation exposure.

**⚠ CAUTION** Please use enough caution not to see the beam directly or touch it in case of an adjustment or operation check.

**VARNING :** Osynlig laserstrålning är denna del är öppnad och spårren är urkopplad. Betrakta ej strålen.

**VARO :** Avattaessa ja suojalukitus ohitettaessa olet alttiina näkymättömälle lasersäteilylle. Älä katso säteeseen.

**ADVARSEL :** Usynlig laserstrålning ved åbning , når sikkerhedsafbrydere er ude af funktion. Undgå udsættelse for stråling.

**ADVARSEL :** Usynlig laserstrålning ved åbning,når sikkerhedsbryteren er avslott. unngå utsettelse for stråling.

## REPRODUCTION AND POSITION OF LABELS

### WARNING LABEL

(Except for the U.S.A.and Canada and UP)

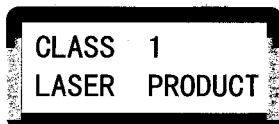

DANGER : Invisible laser radiation when open and interlock or defeated.  
AVOID DIRECT EXPOSURE TO BEAM (e)

VARO : Avattaessa ja suojalukitus ohitettaessa olet alttiina näkymättömälle lasersäteilylle. Älä katso säteeseen. (d)

VARNING : Osynlig laserstrålning är denna del är öppnad och spårren är urkopplad. Betrakta ej strålen. (s)

ADVARSEL : Usynlig laserstrålning ved åbning , når sikkerhedsafbrydere er ude af funktion. Undgå udsættelse for stråling. (f)

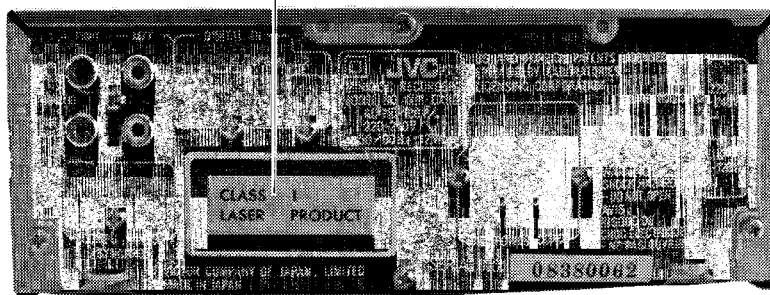

# Instructions

# JVC



## MINIDISC RECORDER

# XM-EX90

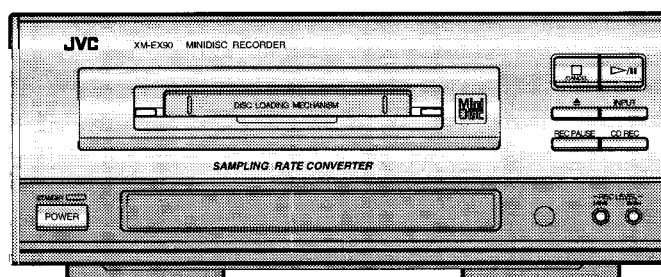
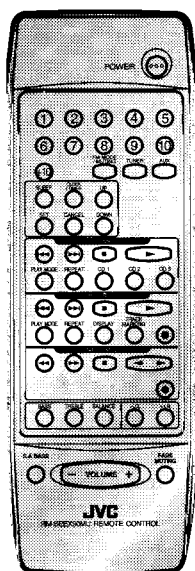

## INSTRUCTIONS

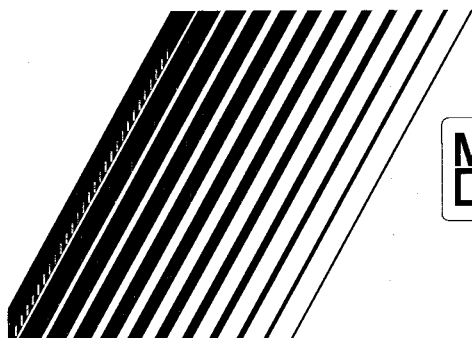

**For Customer Use:**

Enter below the Model No. and Serial No. which are located either on the rear, bottom or side of the cabinet. Retain this information for future reference.

Model No. \_\_\_\_\_

Serial No. \_\_\_\_\_

LVT0097-001A  
[J]

## Welcome !

We would like to thank you for purchasing one of our JVC products. Before connecting this unit to the wall outlet, please read the instructions carefully to ensure that you obtain the best possible performance. If you have any questions, please consult your JVC dealer.

## Important cautions

### Installation of the Unit

- Select a place which is level, dry and neither too hot nor too cold. (Between 5°C and 35°C or 41°F-95°F).
- Leave sufficient distance between the Unit and a TV.
- Be sure to place the Unit in a location with good ventilation.
- Do not use the Unit in a place subject to vibrations.
- Do not place the Unit on a carpet.
- Do not place the Unit on top of another heat-generating piece of equipment.

### Power cord

- Do not handle the power cord with wet hands!
- When unplugging the Unit from the wall outlet, always pull the plug, not the power cord.

### Malfunctions, etc.

- There are no user serviceable parts inside. If anything goes wrong, turn off the power immediately. If the same problem reoccurs when the power is turned on once more, turn off the power again, unplug the power cord and consult your dealer.
- Do not insert any metallic object into the Unit.

## For safe use, observe the following

### Avoid moisture, water and dust

Do not set your machine in moist or dusty places.

### Avoid high temperatures

Do not expose your machine to direct sunlight or set near a heating device.

### Do not block the vents

Poor-ventilation may damage your machine. So do not block the vents or put the unit in a poorly ventilated place.

### When you're away

When away on travel or otherwise for an extended period of time, turn off the power and pull the plug from the electrical socket.

### Do not insert foreign matter into the machine

Do not insert wires, hairpins, coins, etc. into your machine.

### Care of the cabinet

When cleaning your machine, use a soft cloth and follow the relevant instructions on the use of chemically-coated cloths. Avoid applying benzene, thinner or other organic solvents and disinfectants. This may cause deformation or discoloring.

### If water gets inside the machine

Turn off the power and pull the plug from the electrical socket, then call the store where you made your purchase. Using the machine in this state may cause a fire or electrical shock.

US and foreign patents licensed from Dolby Laboratories Licensing Corporation.

# Table of Contents

Welcome !	3	COMPU LINK	48
Important cautions	3	Rule on Digital Copying	50
For safe use, observe the following	3	SCMS (Serial Copy Management System)	50
<b>Parts Index</b>	<b>5</b>	<b>About MD (Mini Disc)</b>	<b>51</b>
Front Panel	5	Role of the cartridge	51
Display	6	Two disc types	51
Rear Panel	7	ATRAC (Adaptive Transform Acoustic Coding)	52
Remote control unit	8	Sound skip guard memory	52
<b>Setting Up the System</b>	<b>10</b>	UTOC (User Table Of Contents)	52
Supplied Accessories	10	<b>MD Error Messages</b>	<b>53</b>
Connection	11	<b>MD Restrictions</b>	<b>54</b>
Remote control batteries	12	<b>Handling MDs</b>	<b>55</b>
Remote control operation	13	<b>Additional Information</b>	<b>56</b>
<b>Playback</b>	<b>14</b>	Troubleshooting	56
MD playback (Basic operation)	14	Specifications	57
Switching the displayed information	16		
Repeat playback	17		
Program playback	18		
Random playback	20		
<b>Recording</b>	<b>21</b>		
MD recording (Basic operation)	21		
CD recording	24		
Radio or tape recording	25		
<b>Editing Functions</b>	<b>26</b>		
MD editing functions	26		
Dividing a track (DIVIDE)	28		
Joining tracks (JOIN)	30		
Moving a track (MOVE)	32		
Erasing a track (ERASE)	34		
Erasing all tracks in an MD (ALL ERASE)	36		
Assigning titles to an MD and its tracks	38		
Assigning titles while playback or recording	41		
<b>Remote Control of the other Components</b>	<b>43</b>		
Remote control of the other optional components from the provided remote control unit	43		
Remote controlling the amplifier/tuner	44		
Remote controlling the CD player and cassette deck	46		

# Parts Index

## Front panel

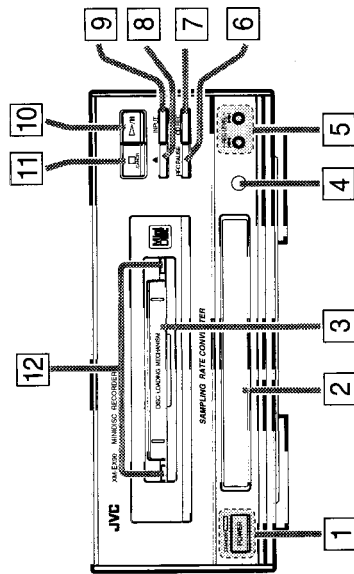

- 1 POWER button**  
Press to switch the power between ON and STANDBY.
- 2 STANDBY indicator**  
The indicator is off while the power is ON and lights up when the power is in STANDBY mode.
- 3 MD insertion slot**  
Load an MD through this slot.
- 4 Remote control sensor**
- 5 REC LEVEL buttons**  
Press to skip to the beginning of a desired track, to fast forward or fast reverse a disc, or adjust the recording level.
- 6 REC PAUSE**  
Press to enter record-pause mode.
- 7 CD REC**  
Press for synchronized recording with the CD player.
- 8 PAUSE button**  
Press to eject the MD.
- 9 INPUT button**  
Press to switch the recording input between the digital and analog inputs. This button should be pressed after pressing REC PAUSE.
- 10 /II button**  
Press to start MD playback or recording, or to let it pause temporarily.
- 11 /CANCEL**  
Press to stop MD playback or recording, or to clear a track in the program.
- 12 Disc indicator**  
Lights in green when the power is switched ON.  
Lights in green during playback, and in red during recording.

## Display

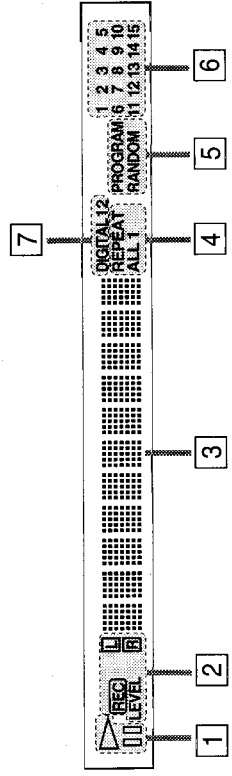

- 1 Play indicators**  
**▷**: Lights up during MD playback or recording.  
**⏸**: Lights up during pause.
- 2 Recording status indicators**  
**REC**: Lights in record and record-pause modes.  
**LEVEL, L, R**: Lights during the analog input level control operation.
- 3 Character display**  
Shows the track information, title, MD editing function, recording-editing function, etc.
- 4 Repeat indicators**  
**REPEAT ALL**: Lights when all tracks in an MD or all tracks in the program are played repeatedly.  
**REPEAT 1**: Lights when a single track is played repeatedly.
- 5 Play mode indicators**  
**PROGRAM**: Lights in the program play mode.  
**RANDOM**: Lights in the random play mode.
- 6 Track indicators**  
Shows the number of tracks in the MD.
- 7 Input mode indicators**  
Shows the recording input mode.  
"DIGITAL 1" or "DIGITAL 2" lights when the respective digital input is used, and no indicator is lit when the analog input is used.

**Rear panel**

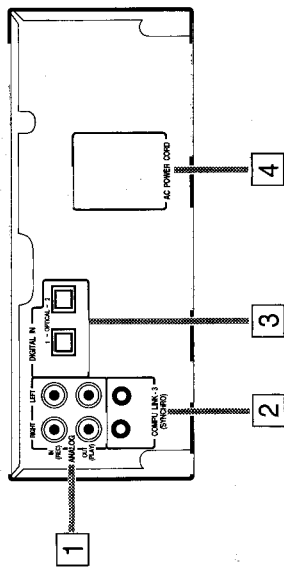

**1 ANALOG input/output jacks**

Connect to the MD output/input jacks of the amplifier/tuner using the provided audio pin cords.

Connect the IN (REC) jacks with the amplifier/tuner's OUT (REC) jacks, and the OUT (PLAY) jacks with its IN (PLAY) jacks.

**2 COMPU LINK-3 (SYNCHRO) jacks**

Connect each jack with the provided COMPU LINK-3 (SYNCHRO) jack of another component.

**3 DIGITAL IN jacks**

Connect using the provided optical digital cable.

**1:** Connect with the DIGITAL OUT jack of the CD player.

**2:** Connect with the DIGITAL OUT jack of your DBS tuner, etc.

**4 AC POWER CORD receptacle**

Connect the provided AC power cord.

**Remote control unit**

**Normal control button panel**

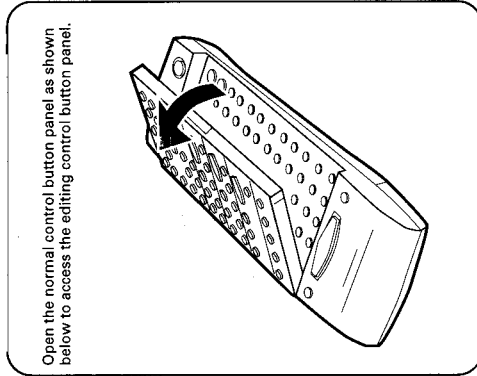
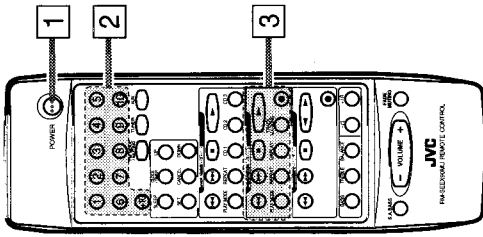

Open the normal control button panel as shown below to access the editing control button panel.

**Editing control button panel**

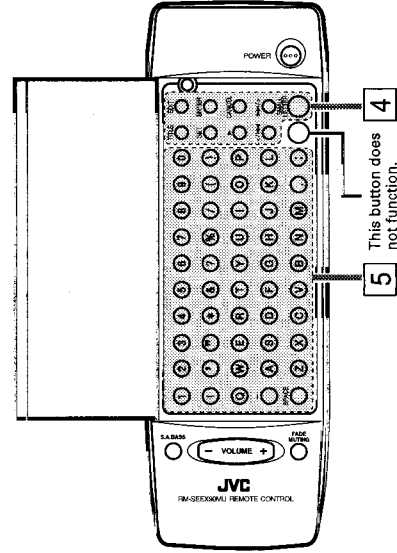



# Setting Up the System

## 1 POWER button

Press to switch the power mode between ON and STANDBY.

## 2 Numeric keys

Press to select a desired track number directly.  
 Press MD CONTROL **▶** before pressing this button.  
 To select track No. 5: Press 5.  
 To select track No. 15: Press +10 then 5.  
 To select track No. 20: Press +10 then 10.  
 To select track No. 32: Press +10 three times then press 2.

## 3 MD CONTROL buttons

Used to control the MD recorder.  
**▶**: Starts playback. Also sets the numeric keys on the remote control unit to the MD mode.  
**■**: Stops playback or recording.  
**◀◀, ▶▶**: Skips to the beginning of a track.  
**⊙**: Initiates record-pause mode.

**PLAY MODE**: Switches the play modes, which include the program play mode and random play mode.

**REPEAT**: Switches the repeat play modes, which include the all-track repeat mode and 1-track repeat mode.

**DISPLAY**: Switches the information shown on the character display.

**TRACK MARKING**: Switches the track assignment during recording between automatic and manual.

## 4 MD editing control buttons

**EDIT**: Switches the editing functions.  
**TITLE**: Assigns a title to a MD or its track.  
**ENTER**: Enters the editing contents in memory.  
**SET**: Sets the point where a track is divided or the track to be edited.  
**▶**: Starts playback.  
**CANCEL**: Cancels an editing item or character.  
**</◀◀ ▶▶>**: Selects a track number or adjust track marking. These keys can be used during editing.  
**SMALL LETTER**: Switches the case of input characters.  
 The characters are uppercase while the button is not lit, and lowercase when it is lit in green.

## 5 Character input keyboard

Used for direct input of characters.

\* The buttons without description are for use in controlling other optional components (see page 43).

## Supplied Accessories

- Power cord x 1
- Audio pin cords x 2
- Optical digital cable x 1
- Remote control unit x 1
- Compu Link cable x 1
- Batteries (R03 (UM-4)/AAA (24F)) x 2

## Cautions for Placement

Do not place in any of the following areas.

- Near a heater or other heat emitting appliance.
- In direct sunlight.
- Do not place the CD player on top of the amplifier/tuner.
- In a place warmer than 35°C (95°F).
- In a bathroom, kitchen or other area with steam, humidity, or hot water.
- In a place with lots of static electricity or dust.
- In an unstable area.
- Near appliances that receive electronic wave broadcasts, such as a television or tuner.

**Connection**

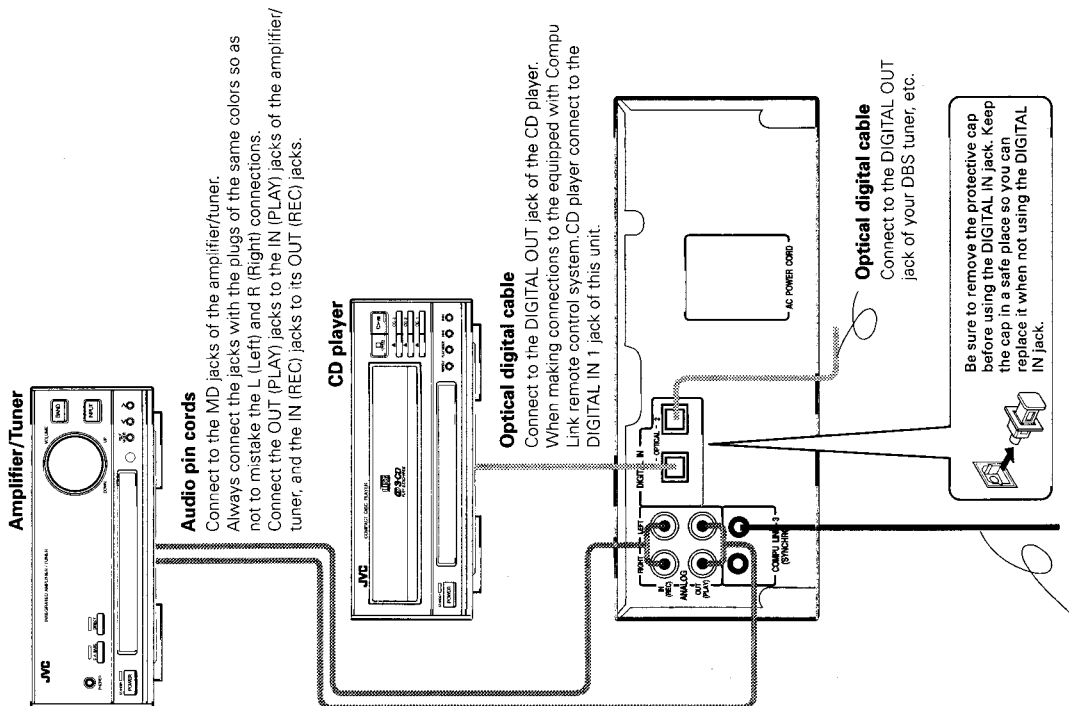

**Compu Link cable**  
Connect to the COMPU LINK-3 (SYNCHRO) jack of another equipped with Compu Link remote control system.

**Remote control batteries**

Load the supplied batteries (2) into the remote control.

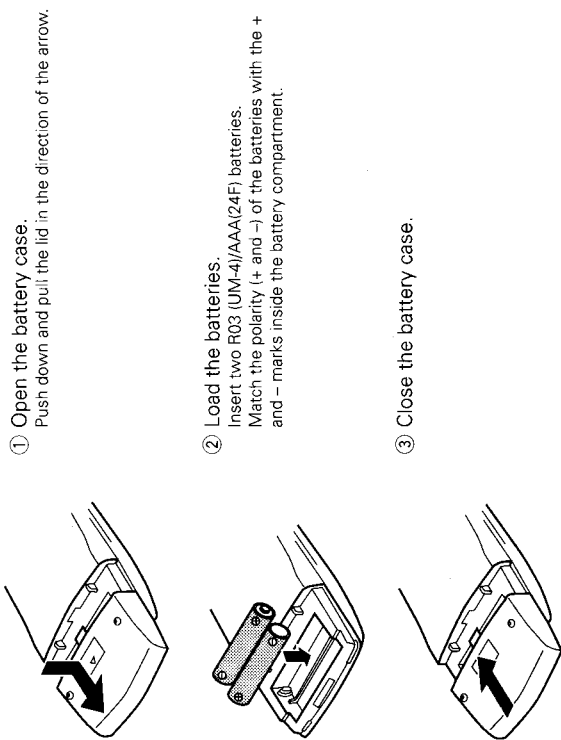

- ① **Open the battery case.**  
Push down and pull the lid in the direction of the arrow.
- ② **Load the batteries.**  
Insert two R03 (UM-4)/AAA(24F) batteries. Match the polarity (+ and -) of the batteries with the + and - marks inside the battery compartment.
- ③ **Close the battery case.**

**Operating the Remote Control**

Point the remote control toward the remote sensor on the front panel. The signal may not reach the remote sensor if the remote control is used at an angle of 60°, or if there are objects between the remote control and the remote sensor.

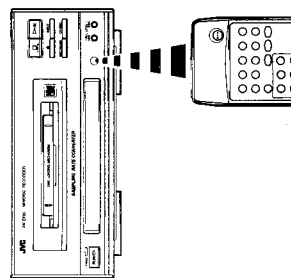

**Cautions**

- Observe the following to avoid battery leakage or explosion:
- If the range or effectiveness of the remote control decreases, replace the batteries using R03 (UM-4)/AAA(24F) type dry cells.
  - Do not use an old battery together with a new one.
  - Do not use different types of batteries together.
  - Do not disassemble the batteries or subject them to high temperatures, like an open fire.
  - Remove the batteries if the remote control will not be used for a long time.

### Remote control operation

The remote control unit has a two-panel configuration, and opening the normal control button panel allows you to access the editing control button panel. Use the normal control buttons for playback and recording operations, and use the editing control buttons for editing and title input operations.

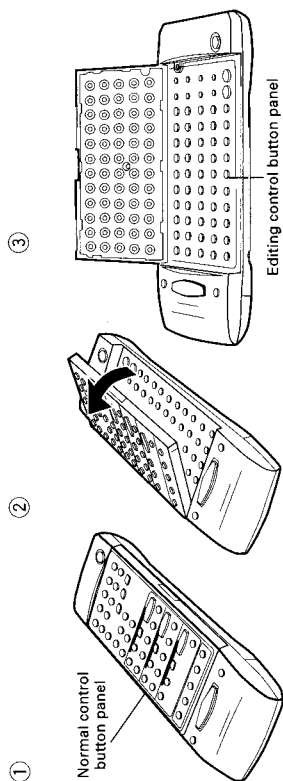

Point the transmitter of the remote control unit toward the remote control sensor on the main unit before pressing a button. If the remote control unit is used from an oblique direction or if there is an obstacle between it and the main unit, the remote control signals may not reach the main unit.

### When using the normal control buttons

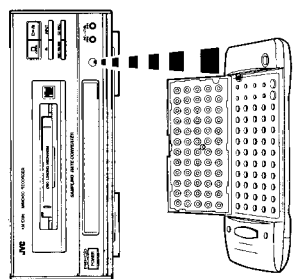
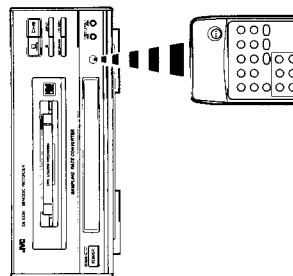

## Playback

### MD playback (Basic operation)

The basic operation for playing an MD is described below. If you use the remote control unit, use the MD CONTROL buttons on the normal control button panel.

- ① Load an MD (Mini Disc).  
Hold an MD with the side on which an arrow is marked facing up, and insert it into the slot in the direction of the arrow. The MD will be pulled in automatically from the middle.

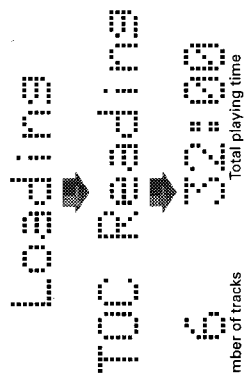
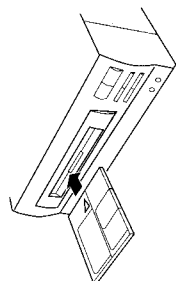

- If the MD has a disc title, the display shows the disc title then the number of tracks and total playing time of the disc.

#### Shortcut:

When the power is in the STANDBY mode, inserting an MD turns the power on and the MD is pulled in automatically.

- ② Press  $\blacktriangle$ /II.

Playback starts. The  $\blacktriangle$  indicator lights up.

- If you are using the remote control unit, press  $\blacktriangle$ .

#### Shortcut:

When the power is in the STANDBY mode, pressing  $\blacktriangle$ /II or  $\blacktriangle$  on the remote control unit turns the power on and starts MD playback automatically. In this case, the display will show "NO DISC" if no MD has been loaded.

- Press  $\square$ /CANCEL to stop playback in the middle. If you are operating the remote control unit, press  $\blacksquare$ .

- Press  $\blacktriangle$  to eject the MD.

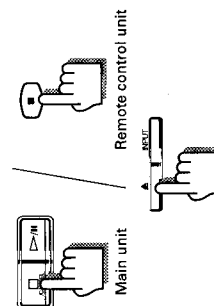
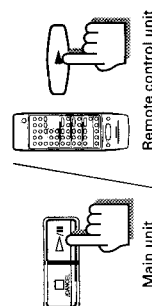

**To let playback pause temporarily:**

Press **⏸/M**. The 00 indicator lights up. Pressing the button again resumes playback from the position where it has paused.

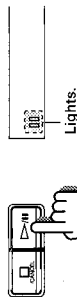

**To skip to the beginning of a track:**

Press **⏮** once to skip to the beginning of the next track.  
 Press **⏮** once to skip to the beginning of the current track being played.  
 • Each press skips an additional track.

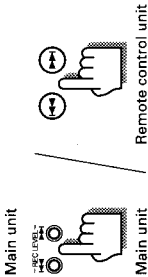

**Fast forward/fast reverse**

These operations are possible while the MD recorder is in play or pause mode.  
 Press and hold **⏭** to fast forward.  
 Press and hold **⏪** to fast reverse.  
 • These operations cannot be controlled from the remote control unit.



**To select and play a desired track**

**Main unit/remote control unit:**

1. Press **⏪** or **⏭** to select a track number.
2. Press **▶** to start playback.

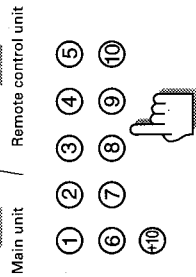
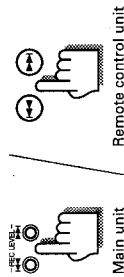

**Remote control unit:**  
 Press **▶** then immediately compose the track number of the desired track.

To select track No. 5: Press 5.  
 To select track No. 15: Press +10 then 5.  
 To select track No. 20: Press +10 then 10.  
 To select track No. 52: Press +10 five times then press 2.

**Switching the displayed information**

The display can show the disc title, track title and remaining time (recording time available when a recordable MD is loaded) information. The displayed information can be switched using DISPLAY of the MD CONTROL buttons of the remote control unit.

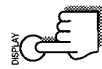

**Press DISPLAY in stop mode.**

Each press of DISPLAY switches the displayed information as follows.

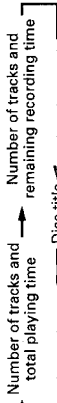

- A disc title composed of more than 11 characters is scrolled, and the first 11 characters are displayed after scrolling.
- The display shows "NO TITLE" if the disc has no title assigned to it.

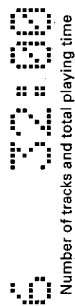

Number of tracks and total playing time



Disc title



Number of tracks and remaining recording time



**When a track has already been selected:**

Each press of DISPLAY switches the information as follows.

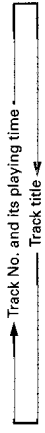

- A track title composed of more than 11 characters is scrolled, and the first 11 characters are displayed after scrolling.
- The display shows "NO TITLE" if the track has no title assigned to it.

**Press DISPLAY in play mode.**

Each press of DISPLAY switches the information as follows.

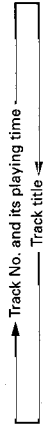

- A track title composed of more than 11 characters is scrolled, and the first 11 characters are displayed after scrolling.
- The display shows "NO TITLE" if the track has no title assigned to it.

**Caution**

Do not mistake the MD insertion direction, otherwise malfunction will result.

### Repeat playback

Repeat playback is possible in two modes. Repeat playback can be set or canceled whether the MD is in stop or play mode. Use the MD CONTROL buttons on the normal control button panel of the remote control unit.

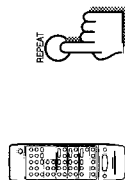

- 1 Press REPEAT to select the repeat play mode. Each press of REPEAT switches the repeat play modes as follows.

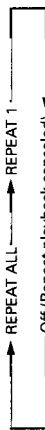

**REPEAT ALL:** Plays all tracks repeatedly.  
**REPEAT 1:** Plays a single track repeatedly.

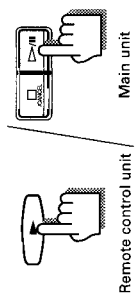

- 2 Press Repeat playback starts.
  - If you are operating the main unit, press .

#### To cancel repeat playback:

Press REPEAT so that the indicators turn off.

### Program playback

Desired MD tracks can be selected and played in the desired order. Use the MD CONTROL buttons on the normal control button panel of the remote control unit.

- 1 Load an MD. See "MD playback (Basic operation)" on page 14.

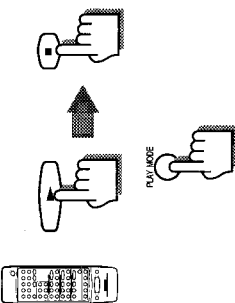

- 2 Press then immediately press . This sets the numeric keys to the MD mode.

- 3 Press PLAY MODE to select PROGRAM. The display shows "PROGRAM" and the PROGRAM indicator lights up.
  - If some tracks have already been programmed, the track number and program number of each track will be displayed.



Each press of PLAY MODE switches the play modes as follows:

- PROGRAM RANDOM Off (Continuous play)
- PLAY MODE can be pressed only in stop mode. Be sure to stop MD before pressing PLAY MODE.

- 4 Select desired track numbers using the numeric keys. Up to 32 tracks can be programmed.

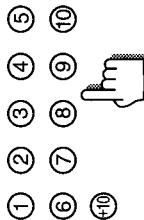

## Random playback

Tracks in an MD be played in a randomly selected order by the MD recorder. The random playback may bring you a surprising effect by playing tracks in a different order every time. Use the MD CONTROL buttons on the normal control button panel of the remote control unit.

- 1 Load an MD.  
See "MD playback (Basic operation)" on page 14.



- 2 Press PLAY MODE to select RANDOM.  
The display shows "RANDOM" and the RANDOM indicator lights up.

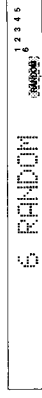

Lights.

Each press of PLAY MODE switches the play modes as shown below.



- PLAY MODE can be pressed only in stop mode. Be sure to stop MD before pressing PLAY MODE.

- 3 Press  $\blacktriangle$ .

Random playback starts.

- If you are operating the main unit, press  $\blacktriangle$ /II.
- Random playback stops after having played every track once.

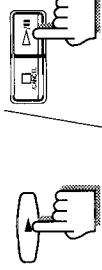

Main unit



Remote control unit

### To exit random play mode:

Press PLAY MODE in stop mode and select any play mode other than RANDOM.

### To repeat random playback:

Combine the random playback and repeat playback to play tracks repeatedly in random orders. The order tracks are played differs every time random playback is repeated.  
For the repeat playback, see page 17.

- 5 Press  $\blacktriangle$ .

Program playback starts.

- If you are operating the main unit, press  $\blacktriangle$ /II.  
Program playback stops after having played all programmed tracks.

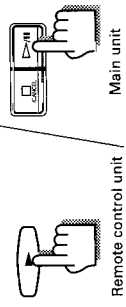

Main unit

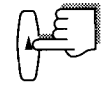

Remote control unit

### To check the programmed tracks and their order:

Press  $\blacktriangle$  or  $\blacktriangleright$  on the remote control unit in stop mode.  
Pressing  $\blacktriangle$  shows programmed track numbers in the order they are programmed (if a track has a title, the title is displayed before the track number). Pressing  $\blacktriangle$  shows them in the reverse order.  
• The programmed tracks cannot be checked by pressing  $\blacktriangle$  or  $\blacktriangleright$  on the main unit.



### To cancel programmed tracks:

Press  $\square$ /CANCEL in stop mode.  
Each press of  $\square$ /CANCEL clears the last track in the program.



### If you make a mistake in programming:

Press  $\square$ /CANCEL in stop mode to clear the last track in the program until the track you programmed by mistake, and re-program tracks from that point.

### To exit program play mode:

Press PLAY MODE in stop mode and select any play mode other than PROGRAM.  
The program contents remain in memory even after the program play mode has been exited.  
• The program contents are cleared from memory when the power cord is unplugged or in case of power failure.



### To clear the program:

Press  $\blacktriangle$ . The programmed tracks are cleared at the moment the MD is ejected.



### To play programmed tracks repeatedly:

Combine the program playback and repeat playback to play the programmed tracks repeatedly.  
For the repeat playback, see page 17.

# Recording

## MD recording (Basic operation)

Audio from a variety of sources can be recorded by using either digital or analog input as required. For the remote control operation, use the MD CONTROL buttons on the normal control button panel of the remote control unit.

- ① Load a recordable MD (Mini Disc).
- ② Press REC PAUSE.
  - The MD recorder enters record-pause mode.
  - If you are operating the remote control unit, press **RECORD**.

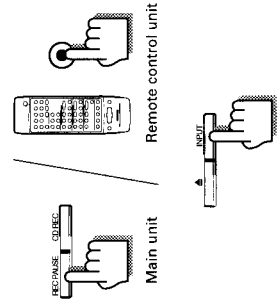

- ③ Select the input by pressing INPUT.
  - Each press of INPUT switches the inputs as follows.
  - DIGITAL 1 IN → DIGITAL 2 IN → ANALOG IN →

**DIGITAL 1 IN:** Select to record the digital input from the source component connected to the DIGITAL IN 1 optical jack. (This input jack is usually connected with optional CD player.)

**DIGITAL 2 IN:** Select to record the digital input from the digital source component connected to the DIGITAL IN 2 optical jack.

**ANALOG IN:** Select to record the analog input from the analog source component (cassette deck, tuner, etc.) connected to the ANALOG IN (REC jacks).

- The input level should be adjusted when the analog input is recorded (see page 22 for the input level control procedure). The input level of the digital inputs does not need adjustment.
- ④ Play the source to be recorded.
- ⑤ Press **▶/II**.
  - Recording starts.
  - If you are operating the remote control unit, press **▶**.

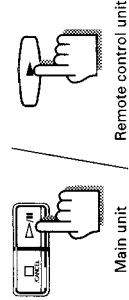

### Notes:

- It should be noted that it may be unlawful to re-record pre-recorded tapes, records, or discs without the consent of the owner of copyright in the sound or video recording, broadcast or cable program and in any literary, dramatic, musical, or artistic embodied therein.
- Carefully read the "Rules of Digital Dubbing" on page 50.

## To stop recording

Press **□/CANCEL** to stop recording.

## To let recording pause temporarily:

Press REC PAUSE. To resume recording, press **▶/II** or **▶** of the remote control unit.

## To adjust the analog input level

The input level should be adjusted when the analog input is recorded. Start playing the source before proceeding to the level control.

- ① In record-pause mode, press **◀** or **▶**. The level control display appears.
  - The level control display appears for 5 seconds. If no button has been pressed in this period, the display returns to the record-pause mode display.

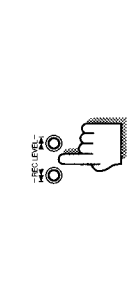

- ② Adjust the input level by pressing **◀** or **▶**. Adjust so that these segments blink at the peak level.
  - The level indicator blinks when the input level is too high. Adjust the input level as described above. Too high an input level results in distorted recording.
  - The input level can be adjusted in the range from -50 to 0.

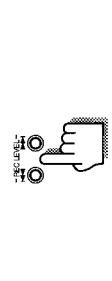

## To display the remaining recording time:

Press DISPLAY in record or record-pause mode. Each press of DISPLAY switches the elapsed recording time display and remaining recording time display alternately.

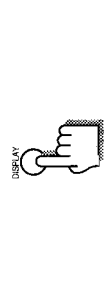

**Track marking:**

The track numbers on an MD (Mini Disc) are marked at the beginning of each track. The track numbers are identified by these "track markings" and each section between two track markings are considered as a track. This MD recorder can record the track markings either automatically (AUTO) or manually (MANUAL).

- Track markings can be recorded during audio recording.

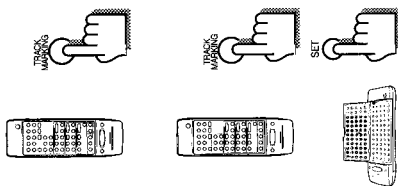

**Automatic track marking:**

Press TRACK MARKING on the normal control button panel of the remote control unit to select "AUTO".



- A track marking is recorded every time a blank of 3 seconds is detected.

**Manual track marking:**

1 Press TRACK MARKING on the normal control button panel of the remote control unit to select "MANUAL".



- 2 When the point you want to record a track marking comes during recording, press SET on the editing control button panel. This records a track marking in the point where the button is pressed.

- When CDs are recorded from CD player equipped with the Compu Link remote control system, CD player track markings are recorded automatically at the points where the CD tracks change.

**CD recording**

The digital input from CDs can be recorded with a simple, one-touch operation by switching the input automatically. This method is available only when the Compu Link connection has been made among other optional components equipped with the Compu Link remote control system.

- 1 Load a recordable MD (Mini Disc).
- 2 Prepare the CD player. Load CDs, press CD 1, CD 2 or CD 3 according to the disc you want to record, then immediately press of the CD player. This selects the played CD. Now set the CD player to the program play mode, etc., as required.
- 3 Press CD REC. The CD player and MD recorder start simultaneously and synchronized recording starts.
  - The DIGITAL 1 input is selected automatically and the DIGITAL 1 indicator lights up.

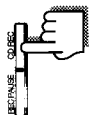

**To stop recording:**

Press /CANCEL to stop recording.

**Synchronized recording of the analog input**

This method is available only when the Compu Link connection (page 48) has been made among the components.

- 1 Load a recordable MD (Mini Disc).
- 2 Prepare the CD player.
- 3 Start playing a CD.
- 4 Press REC PAUSE. The MD recorder enters record-pause mode.
- 5 Press INPUT to select the analog input and adjust the input level (see page 22).
- 6 Press of the CD player. The CD player enters stop mode.
- 7 Press /II of the CD player. Synchronized recording starts.



### Radio or tape recording

The analog input from an analog source component can be recorded on an MD as described below. If you are operating the remote control unit, use the MD CONTROL buttons on the normal control button panel.

- ① Load a recordable MD (Mini Disc).
- ② Prepare the amplifier/tuner or cassette deck. With the amplifier/tuner, receive the station to be recorded. With the cassette deck, load the tape to be recorded. Switch the reverse mode on if you want to record the playback of both sides.
- ③ Press REC PAUSE. The MD recorder enters record-pause mode.
- ④ Press INPUT to select the analog input. Press so that "ANALOG IN" appears on the display (see page 21).
- ⑤ Press ◀▶ or ▶▶ to adjust the input level. See "To adjust the analog input level" on page 22. When recording from the cassette deck, start playing the tape before proceeding to the input level control. After the input level control, rewind tape to the beginning of the music to be recorded.
- ⑥ Press ▶/II. Recording starts.
  - If you are operating the remote control unit, press ▶
  - When recording radio broadcast from the tuner, it is convenient for later editing to record track markings manually during recording (see page 23).
  - When recording from the cassette deck, go to step ⑦.
- ⑦ With the cassette deck, press ◀ or ▶.

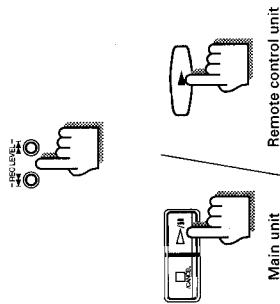
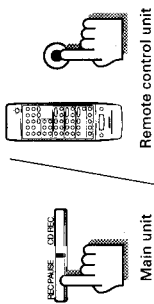

## Editing Functions

### MD editing functions

A recorded MD can be edited in many ways. The editing functions include the division, joining, moving, erasing a single track, erasing the entire disc and assigning titles to the disc and tracks, and more than one of them can be combined as required. Use the editing control button panel of the remote control unit.

#### Dividing a track (DIVIDE) Page 28

This function divides a track by adding track marking(s) in desired point(s) in the middle or where you want to search later.

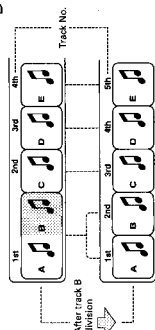

#### Joining a track (JOIN) Page 30

This function joins two adjacent tracks into a single track by deleting a track marking.

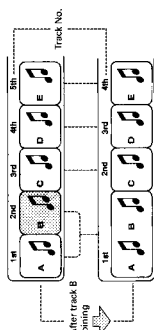

#### Moving a track (MOVE) Page 32

This function moves a track by reordering the track numbers.

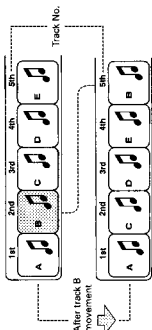

#### Erasing a track (ERASE) Page 34

This function erases a specified track. After the erasure, the subsequent tracks are justified and their track numbers are decremented automatically.

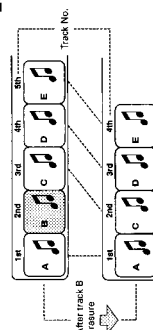

#### Erasing all tracks (ALL ERASE) Page 36

This function erases data in a disc entirely.

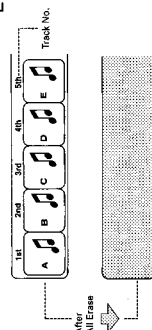

**Combining editing functions**

By combining "DIVIDE", "ERASE" and "JOIN", for example, it is possible to erase only a part of existing track.

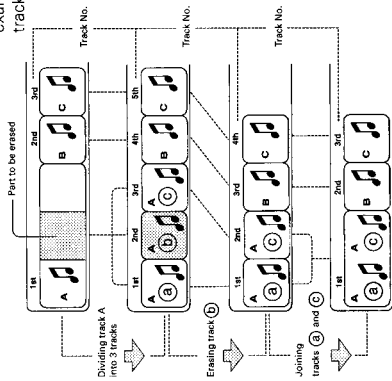

**Assigning titles**

A title can be assigned to a track or disc. Once a title is assigned, it is displayed in later playback for confirmation. Each title can be composed of up to 64 characters, and can be input using any of character types alphabets (uppercase and lowercase), symbols and numerals.

In the editing and title assignment operations, use the editing control buttons of the remote control unit.

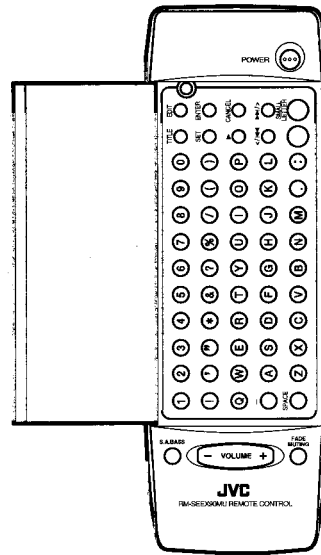

**Dividing a track (DIVIDE)**

A track can be divided into desired number of tracks by adding track markings in the middle, in the desired points or where you want to search later. This makes it possible to assign track numbers after recording medley music or FM broadcast. The track numbers after the divided track are incremented automatically.

- 1 Press EDIT to select "DIVIDE".

Each press of EDIT switches the editing functions as follows.

DIVIDE → JOIN → MOVE → ERASE → ALL ERASE

MD total playing time display
- 2 Press SET.

Blinks.
- 3 Play the track to be divided.

Select the track number by pressing </> or </> or </> then press ▲.

Blinks.
- 4 Press SET when a point where you want to divide the track comes.

"POSITION" is displayed then the track marking fine adjustment display appears.

Blinks.

Example) When track No. 3 is selected

Blinks. Increments by 1.

Example) Track No. 3 and 4 blink and the 3-second section from the divided point will be played repeatedly.

  - When the track has been divided as desired, go to step 6.
  - If the track has not been divided as desired, fine-adjust the track marking position. Go to step 3.
  - If you notice that the selected track number is wrong, press CANCEL and select the correct track number.

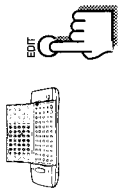

### Joining tracks (JOIN)

Two adjacent tracks can be joined into a single track by deleting the unnecessary track marking. This also makes it possible to join more than two tracks into a single track or a piece of music divided into multiple tracks into a single piece. The track numbers after the joined tracks are decremented automatically.

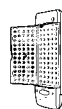

- 1 Press EDIT to select "JOIN".  
Each press of EDIT switches the editing functions as follows.

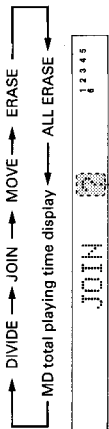

Blinks.

- 2 Press SET.



- 3 Select the track to be joined with the previous track.  
Select the track number by pressing </> or <|> or >|> or >/.  
Example) To join track numbers 1 and 2, select track number 2 here.

Blinks.

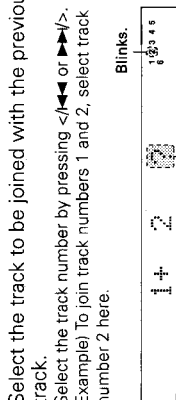

- 4 Press SET.  
Track numbers 1 and 2 blink, indicating that these tracks will be joined into one.

Blinks.

Example) When track No. 2 is selected

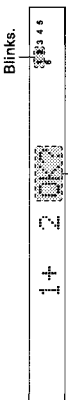

- If you selected a wrong track number, press CANCEL and return to step 3.



- 5 Fine-adjust the track marking position by pressing </> or <|> or >|> or >/.  
The track marking position can be fine-adjusted in the range of ±128 positions (approx. ±8 sec.).  
As you press the button, the track marking displaces slightly and the 3-second section from the newly divided point will be played repeatedly.

- After completing the fine-adjustment, go to step 6.

### To correct a previously fine-adjusted track marking position:

- 1 Press CANCEL.
- 2 Select the track number by pressing </> or <|> or >|> or >/.  
and press >.
- 3 Return to step 4.

- 6 Press ENTER.

The change made above is entered temporarily in the memory. The display shows "EDITING".

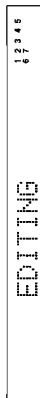

- 7 Press > to eject the MD.  
The data in the memory is written in the MD before it is ejected.  
The display shows "JTOC writing" during MD write operation.

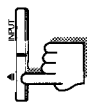

- Be careful not to apply impact to the MD recorder during writing data in the memory in the MD. Otherwise the recording may be unplayable later.
- The data in the memory is written in the MD also when the power is switched to the STANDBY mode while "EDITING" is being displayed.

### To exit editing:

Press EDIT before pressing ENTER in step 6.

### To restore the original track from the divided tracks:

Use the JOIN editing function.  
See "Joining tracks (JOIN)" on page 30.

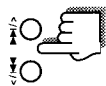

⑤ Press ENTER.

The change made above is entered temporarily in the memory. The display shows "EDITING".

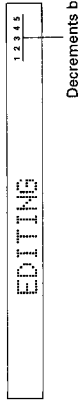

⑥ Press ▲ to eject the MD.

The data in the memory is written in the MD before it is ejected. The display shows "UTOC writing" during MD write operation.

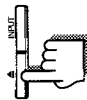

- Be careful not to apply impact to the MD recorder during writing data in the memory in the MD. Otherwise the recording may be unplayable later.
- The data in the memory is written in the MD also when the power is switched to the STANDBY mode while "EDITING" is being displayed.

**To exit editing:**

Press EDIT before pressing ENTER in step ⑤.

**To restore the original tracks from the track obtained by joining:**

Use the DIVIDE editing function. See "Dividing tracks (DIVIDE)" on page 28.

**Moving a track (MOVE)**

A track can be moved to the desired position by selecting its track number and the destination track number.

① Press EDIT to select "MOVE". Each press of EDIT switches the editing functions as follows.  
 → DIVIDE → JOIN → MOVE → ERASE → ALL ERASE  
 MD total playing time display

② Press SET. "1" for track number 1 blinks on the display.  
 Blinks.

③ Select the track number to be moved, then press SET. Select the track number by pressing </> or </>.  
 Blinks.

④ Select the movement destination track number, then press SET. Select the track number to be given to the selected track by pressing </> or </>.  
 Blinks.

Example) When track No. 2 is to be moved and selected a wrong track number, press CANCEL and select the correct track number.

Example) When track No. 5 is selected and return to step ③.

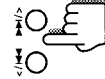
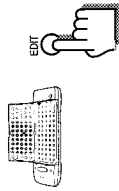

⑤ Press ENTER.

The change made above is entered temporarily in the memory. The display shows "EDITING".

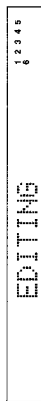

⑥ Press ▲ to eject the MD.

The data in the memory is written in the MD before it is ejected. The display shows "UTOC writing" during MD write operation.

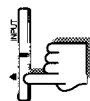

- Be careful not to apply impact to the MD recorder during writing data in the memory in the MD. Otherwise the recording may be unplayable later.
- The data in the memory is written in the MD also when the power is switched to the STANDBY mode while "EDITING" is being displayed.

**To exit editing:**

Press EDIT before pressing ENTER in step ⑤.

**Erasing a track (ERASE)**

A desired track can be erased from the MD. The track numbers after the erased track are decremented automatically.

① Press EDIT to select "ERASE".

Each press of EDIT switches the editing functions as follows.

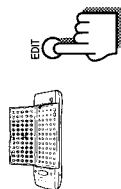
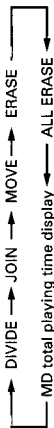

② Press SET.

"1" for track number 1 blinks on the display.

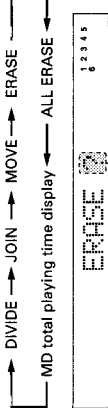

③ Select the track number to be erased, then press SET.

Select the track number by pressing </> or >/>.

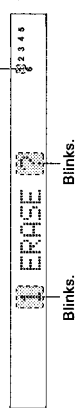

④ Select the track number to be erased, then press SET.

Select the track number by pressing </> or >/>.

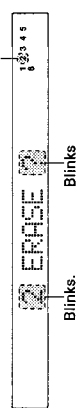

Example) When track No. 2 is to be erased



Example) When SET is pressed

- If you selected a wrong track number, press CANCEL and select the correct track number.
- If the display shows "TRACK PROTECTED", the selected track has been protected against accidental erasure by other component than the MD recorder in use. If you still want to erase the track, go to step ④. If you will not erase it, press EDIT.

④ Press ENTER.

The change made above is entered temporarily in the memory. The display shows "EDITING".

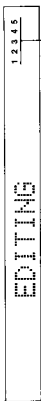

Decrements by 1.

⑤ Press ▲ to eject the MD.

The data in the memory is written in the MD before it is ejected. The display shows "UTOC writing" during MD write operation.

- Be careful not to apply impact to the MD recorder during writing data in the memory in the MD. Otherwise the recording may be unplayable later.
- The data in the memory is written in the MD also when the power is switched to the STANDBY mode while "EDITING" is being displayed.

**To exit editing:**

Press EDIT before pressing ENTER in step ④.

**Erasing all tracks in an MD (ALL ERASE)**

The data recorded in an MD can be erased entirely to turn the MD into a blank disc.

① Press EDIT to select "ALL ERASE".

Each press of EDIT switches the editing functions as follows.

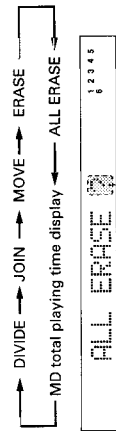

② Press SET.

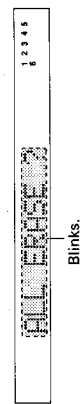

- If the display shows "TRACK PROTECTED", the selected track has been protected against accidental erasure by other component than the MD recorder in use. If you still want to erase the track, go to step ③. If you will not erase it, press EDIT.

③ Press ENTER.

The change made above is entered temporarily in the memory. The display shows "EDITING".

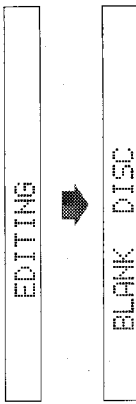

**Caution**

Once erased, the track can never be restored. An MD containing recording that you do not want to erase should be protected by sliding the tab (see page 55).

### Assigning titles to an MD and its tracks

Titles can be assigned to a recorded MD and tracks selected from it. This operation is possible while the MD recorder is in stop mode.

#### ④ Press ▲ to eject the MD.

The data in the memory is written in the MD before it is ejected. The display shows "UTOC writing" during MD write operation.

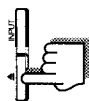

- Be careful not to apply impact to the MD recorder during writing data in the memory in the MD. Otherwise the recording may be unplayable later.
- The data in the memory is written in the MD also when the power is switched to the STANDBY mode while "EDITING" is being displayed.

#### To exit editing:

Press EDIT before pressing ENTER in step ③.

#### ① Load a recorded MD (Mini Disc).

#### ② Press TITLE.

The display shows "DISC/NO TITLE".

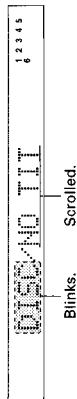

- If a disc title has already been assigned, the title is displayed.

If you want to assign **only the disc title**, go to step ③.

If you want to assign **the track titles**, press </> or >/> to select **the track to be titled** then go to step ③.

- To vary track numbers in the backward direction, press <<.



#### ③ Press SET.

The cursor starts blinking.



#### Caution

Once erased, the tracks can never be restored. An MD containing recording that you do not want to erase should be protected by sliding the tab (see page 55).

④ Input the title.

- 1 Select the character case. Each press of SMALL LETTER switches the character case. Lowercase letters can be input when the button is lit in green, and uppercase letters can be input when the button is not lit.
- 2 Input characters by pressing the character input keys. Up to 64 characters can be input per title.

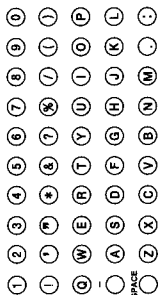
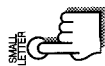

⑤ Press ENTER.

The characters input above are entered temporarily in the memory. The display shows "EDITING", then scrolls the input title, and finally shows the number of tracks and total playing time of the MD.

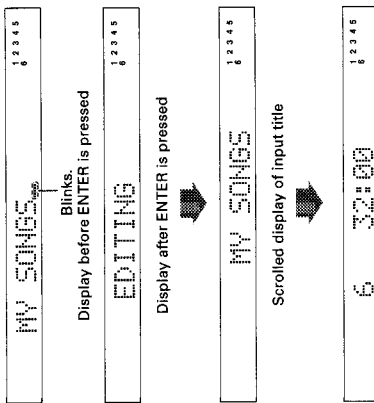

⑥ Press **▲** to eject the MD.

The data in the memory is written in the MD before it is ejected. The display shows "UTOOC writing" during MD write operation.



- Be careful not to apply impact to the MD recorder during writing data in the memory in the MD. Otherwise the recording may be unplayable later.
- The data in the memory is written in the MD also when the power is switched to the STANDBY mode while "EDITING" is being displayed.

To correct input characters:

Characters can be corrected only before ENTER is pressed.

- 1 Press </> or <|> to move the cursor to the character to be corrected.
- 2 Press CANCEL to erase the character.
- 3 Input the correct character.

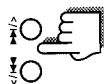

To cancel all input characters:

Characters can be cleared only before ENTER is pressed. Press CANCEL to erase all characters then press TITLE.

To exit editing:

Press TITLE before pressing ENTER.



### Assigning titles while playback or recording

Track titles can be assigned as you play or record the tracks.

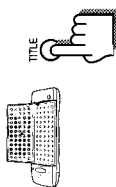

- 1 After start of playback or recording of a track, press TITLE.



Blinks.

- 2 Input the track title.

- 1 Select the character case.  
Each press of SMALL LETTER switches the character case.  
Lowercase letters can be input when the button is lit in green, and uppercase letters can be input when the button is not lit.
- 2 Input characters by pressing the character input keys.  
Up to 64 characters can be input per title.

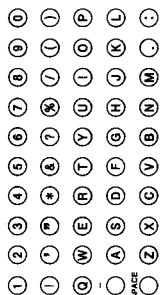

- 3 Press ENTER.

The characters input above are entered temporarily in the memory. The display shows "EDITING".

- If it is during playback, the track will be played repeatedly until ENTER is pressed. Pressing ENTER stops the playback.
- If it is during recording, recording continues even after ENTER is pressed. If ENTER is not pressed until the end of the track, the characters input before the end of the track are recorded.

- 4 Press to eject the MD.

The data in the memory is written in the MD before it is ejected.  
The display shows "UTOC writing" during MD write operation.

- Be careful not to apply impact to the MD recorder during writing data in the memory in the MD. Otherwise the recording may be unplayable later.
- The data in the memory is written in the MD also when the power is switched to the STANDBY mode while "EDITING" is being displayed.

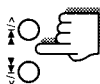

### To correct input characters:

Characters can be corrected only before ENTER is pressed.

- 1 Press </> or <|> or >>>/> to move the cursor to the character to be corrected.
- 2 Press CANCEL to erase the character.
- 3 Input the correct character.

### To cancel all input characters:

Characters can be cleared only before ENTER is pressed.

Press CANCEL to erase all characters then press TITLE.

### To exit editing:

Press TITLE before pressing ENTER.

## Remote Control of the other Components

### Remote control of the other optional components from the provided remote control unit

The remote control unit provided with the MD recorder can be used to control the amplifier/tuner CD player and cassette deck equipped with the Compu Link remote control system. The amplifier/tuner is controlled directly while the CD player and cassette deck are controlled with the help of the Compu Link system (page 48).  
Point the remote control unit to the remote control sensor of the amplifier/tuner to operate other components.

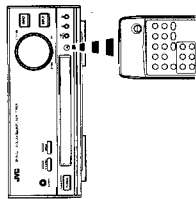

#### Remote controlling the amplifier/tuner (Page 44)

The amplifier, tuner and timer operations can be controlled.

To switch the amplifier power between ON and STANDBY from the remote control unit provided with the MD recorder, set the POWER control mode to the amplifier/tuner mode.

#### Switching the POWER button's control mode

##### Amplifier/tuner mode:

Press POWER and "1" on the normal control button panel simultaneously.  
This makes it possible to switch the amplifier/tuner power between ON and STANDBY.

- In this mode, the MD recorder power cannot be switched between ON and STANDBY by remote control.

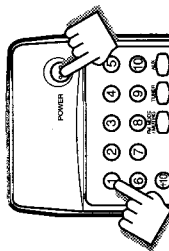

##### MD recorder mode:

Press POWER and "10" on the normal control button panel simultaneously.  
This makes it possible to switch the MD recorder power between ON and STANDBY.

- In this mode, the amplifier/tuner power cannot be switched between ON and STANDBY by remote control.

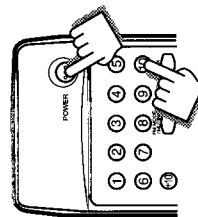

Remote controlling the CD player (Page 46)

Remote controlling the cassette deck (Page 46)

### Remote controlling the amplifier/tuner

The remote control unit can control the amplifier/tuner equipped with the Compu Link remote control system directly.

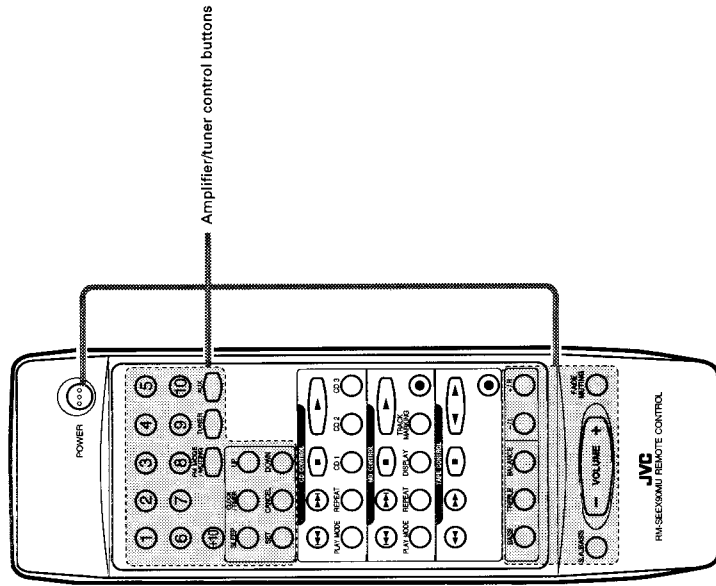

## Remote controlling the CD player and cassette deck

The remote control unit can control CD player and cassette deck equipped with the Compu Link remote control system (page 48). Always point the remote control unit to the remote control sensor on the amplifier/tuner.

### CD player control buttons

- ▶: Starts playback.
  - : Stops playback or recording.
  - ◀◀ ▶▶: Skips to the beginning of a track.
  - ▶▶ ▶▶: Skips to the beginning of a track.
  - REPEAT: Switches the repeat play modes.
  - CD 1: Plays the CD with disc number 1.
  - CD 2: Plays the CD with disc number 2.
  - CD 3: Plays the CD with disc number 3.
- Pressing ▶ or CD 1, CD 2 or CD 3 sets the numeric keys to the CD control mode.

### Numeric keys

- 1 to 10, +10: Used to select a track number directly.
- Track No. 5: Press 5.
- Track No. 15: Press +10 then 5.
- Track No. 20: Press +10 then 10.
- Track No. 32: Press +10 three times then press 2.

### Cassette deck control buttons

- ▶▶ ▶▶: Starts playback.
- : Stops playback or recording.
- ◀◀ ▶▶: In play mode, skips to the beginning of a tune (Music Scan). In stop mode, fast forwards or rewinds tape.
- : Initiates record-pause mode.

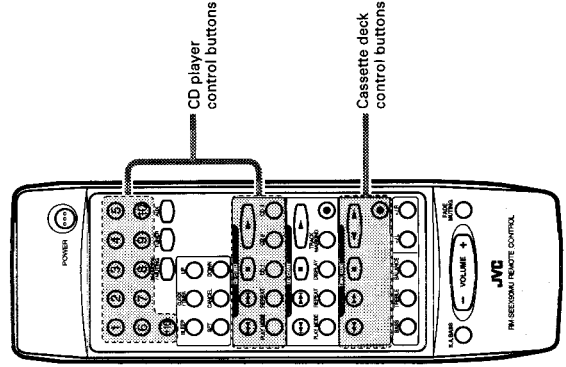

### VOLUME +/-

Adjust the volume.  
Pressing + increases the volume and pressing - decreases it.

### FADE MUTING:

Sets the volume to 0. Pressing again returns to the original volume.

For detailed operation description, refer to the instruction manual of the amplifier/tuner (RX-EX70/90).

\* In the timer setting and clock setting, use DOWN and UP of the remote control unit provided with the MD recorder, in place of +/R and -/L as described in the amplifier/tuner's instruction manual.

### POWER:

Switches the power between ON and STANDBY.

- Before remote controlling the amplifier/tuner, set the POWER control mode to the amplifier/tuner mode (see page 43).

### Numeric keys (1 to 10, +10):

Selects preset channels.

### FM MODE/MUTING:

Press to switch the FM mode between AUTO and MONO.

### TUNER:

Press to select the tuner as the sound source and set the numeric keys (1 to 10, +10) on the remote control unit to operate the tuner. Press repeatedly to switch the band (FM or AM).

### AUX:

Press to select the component connected to the amplifier/tuner's AUX jacks as the sound source.

### SLEEP:

Sets or releases the sleep timer.

### CLOCK/TIMER

Used when setting the timer or clock.

### SET:

Sets a timer or clock.

### CANCEL:

Cancel a timer operation.

### DOWN, UP:

Used when setting the timer or clock.

### BASS:

Used when controlling low frequencies. After pressing BASS, adjust the level by pressing +/R or -/L.

### TREBLE:

Used when controlling high frequencies. After pressing TREBLE, adjust the level by pressing +/R or -/L.

### BALANCE:

Used when controlling the balance between the left and right channels. After pressing BALANCE, adjust the level by pressing +/R or -/L.

### +/R, -/L:

Press when setting the balance, treble and bass.

### S. A. BASS:

Switches the function for enhancing the low frequencies.

# COMPU LINK

## Linked Operation of the Other Optional Components (Compu Link)

The EX series components can be controlled under linked operation provided by the JVC's Compu Link remote control system.

### What is Compu Link

The world of single components, in which you purchase a cassette deck, CD player, amplifier and other components separately and enjoy your own composition, is an effective means for pursuit of high-quality reproduction. However, in terms of operability, the need of controlling components independently makes their control complicated and their linked operation impossible. Then, isn't it possible to combine single component and control them as simply as an integrated audio system? The Compu Link remote control system is the response to such a requirement. The components in the JVC EX series are equipped with jacks named COMPU LINK-3 (COMPU LINK jacks). By connecting the COMPU LINK jacks of these components, they can be controlled simply with a systematized, linked operation.

### Compu Link connections

Using Compu Link cables, connect the COMPU LINK jacks of EX series components. Connect so that the Compu Link cables can bridge all of the EX series components you have. The components can be connected in any order.

## Operation Examples

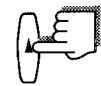

### Program playback of CDs

- 1 Press then immediately press . This sets the numeric keys of the remote control unit to the CD mode.



PLAY MODE

- 2 While the CD player is in stop mode, press PLAY MODE to select "PROGRAM".

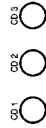

CD.1

- 3 Select a disc number. Press CD 1, CD 2 or CD 3.



1 2 3 4 5

6 7 8 9 10



- 4 Select a track number using the numeric keys.

- 5 Program other tracks by repeating steps 3 and 4.



- 6 Press . Program playback starts.

### Recording of cassette tapes

- 1 Load the tape for use in recording in the tape tray of the cassette deck.



- 2 Press . The cassette deck enters record-pause mode.

- 3 Play the source to be recorded.



- 4 Press or . Recording starts.

## Rule on Digital Copying

The digital audio equipment exchange audio signals in the digital forms through digital input/output jacks, and include the CD (Compact Disc) player, MD (Mini Disc) recorder and DAT (Digital Audio Tape) recorder. The digital audio equipment allows digital copy of signals with little deterioration of music signals. This has made it necessary to have a copy restriction rule for protecting the copyright, and the SCMS has been established as a result.

### SCMS (Serial Copy Management System)

With a view to protecting the copyright, the SCMS restricts the number of generations permitted for copying of signals in the digital form between digital audio equipment to only one generation.

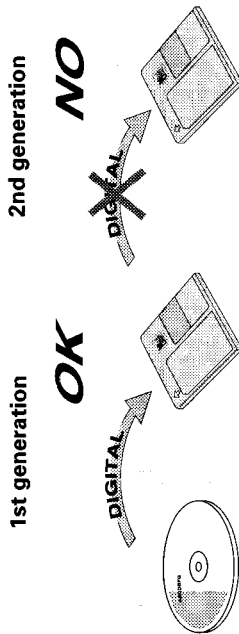

### Caution

Because of this rule, the MD obtained by recording a CD on the MD recorder cannot be copied in the digital form on other digital equipment.

### Shortcut playback

Simply selecting an input source of the amplifier/tuner starts playback of the selected source component (CD player, MD recorder or cassette deck).

Also, even if you do not touch the amplifier/tuner, starting playback of a source component sets the amplifier's input source automatically to the played component.

\* Refer to the instruction manual of amplifier/tuner.

### A single remote control unit

The remote control unit provided with the amplifier/tuner can also be used to control the CD player or cassette deck.

(See "Remote Control of the Other Optional Components" on page 43.)

### Synchronized recording

Recording can be started automatically in synchronism with the start of playback of a source component.

### Timer operation

The timer function built into the amplifier/tuner can be used to start recording or playback of other components at the reserved time of the day or switch the power to the STANDBY mode in the reserved time period.

\* Refer to the instruction manual of amplifier/tuner.

## About MD (Mini Disc)

The MD (Mini Disc) is a new digital audio medium using a disc with a diameter of 64 millimeters. In spite of the small size, the MD has multiple functions, high audio quality and recording/playback capabilities for up to 74 minutes.

### Role of the cartridge

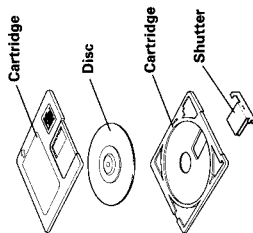

The MD cartridge has a pocket size of 68 mm x 72 mm with a thickness of 5 mm. The cartridge accommodates the 64 mm diameter disc for ease of transportation and storage. The internal disc is usually protected by the cartridge shells and shutter so no dust, dirt, scratch or fingerprint is left on the disc and the disc handling is easy.

### Two disc types

The MD (Mini Disc) includes two disc types, the recordable MD that can be recorded onto and the playback-only MD that can exclusively be played back. Although both types of discs are played in the same way, that is, by irradiating a laser beam on the disc and reading signals from the reflected light, the ways they are recorded are completely different.



Playback-only MD

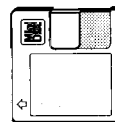

Recordable MD

### Playback-only MD

This type of disc is used in prerecorded MD software marketed in music stores. It cannot be recorded by the user and data is recorded in the same way as a CD, i.e. according to the presence or absence of small holes called pits. A disc recorded in this way is referred to as an "optical disc".

### Recordable MD

This type of disc records data using the magnetism to allow repeated data recording operations. A disc recorded in this way is referred to as an "MO (Magneto-Optical) disc".

### ATRAC (Adaptive Transform Acoustic Coding)

The MD (Mini Disc) has half the size of the CD but can record data for the same period of time. This has been made possible by the newly developed ATRAC (Adaptive Transform Acoustic Coding), which compresses data by cutting the audio components that are inaudible to the human sense of audition. This technology reduces the recorded data to about 1/5 the original data quantity and enables recording/playback of data for up to 74 minutes.

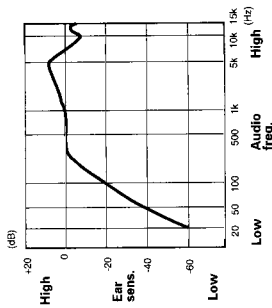

### Sound skip guard memory

The sound skip guard memory stores some data of the played track so that the played audio does not skip due to vibration during MD (Mini Disc) playback.

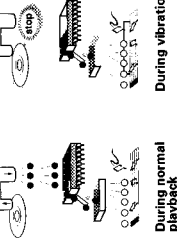

In case the optical laser cannot read disc signal due to vibration, the actually reproduced audio is not interrupted because the data stored in the guard memory is available.

### UTOC (User Table Of Contents)

The recordable MD (Mini Disc) contains the recording of UTOC (User Table Of Contents) in addition to music data itself. The UTOC includes the information on the positions the tracks are recorded, markings between tracks and order of tracks, so tracks can be searched quickly by referring to it. The editing operations consist of altering the UTOC contents and the actual music data does not need to be re-recorded.

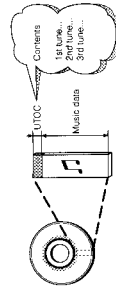

## MD Error Messages

The display of the MD recorder may show the error messages which are explained in the following table.

Error Messages	Description	Treatment
BLANK DISC	The loaded disc is a non-recorded disc.	Use a recorded disc unless you want to start recording on a blank disc.
CANNOT JOIN	An attempt is made to join tracks that cannot be joined.	This is one of system restrictions on the MD. [See page 54.]
DISC ERROR	The MD is abnormal (damaged).	Use another MD.
DISC FULL	The disc has no available space or the number of tracks has reached 254.	Use another recordable MD.
EMERGENCY STOP	An abnormality occurred during recording.	Press <b>DISC/CANCEL</b> to enter stop mode, then press <b>▲</b> to eject the MD and retry recording.
NO DISC	No MD is loaded.	Load an MD.
NON-AUDIO CANNOT COPY	An attempt is made to digitally dub a CD-ROM (Video CD, etc.).	Stop recording.
PLAYBACK DISC	An attempt is made to record on or edit a playback-only MD.	Use a recordable MD.
DISC PROTECTED	The MD is protected against accidental erasure.	Slide the protect tab of the MD. [See page 55.]
TRACK PROTECTED	A track has been protected against accidental erasure by other component that the MD recorder in use.	This protection cannot be released by the MD recorder being used. Release it using the MD recorder which activated the protection.
SCMS CANNOT COPY	An attempt is made to copy a digitally dubbed copy.	Use the analog input for recording.
DIGITAL IN UNLOCK	A wrong digital input is selected.	Press <b>INPUT</b> to select the correct digital input.

## MD Restrictions

The MD uses a unique data recording format that is different from the formats used by Cassettes tape and DAT. Due to the restrictions imposed by this MD recording format, following symptoms may be observed. Note that these symptoms do not indicate malfunction of the product.

Symptom	Cause
"DISC FULL" is displayed before the available recording time indicated on the disc has been used.	The number of tracks that can be recorded on an MD is limited regardless of the time period. It is not possible to record a 255th track.
"DISC FULL" is displayed although there remains margin in both the number of tracks and available recording time.	After partial erasure and re-recording are repeated, the disc comes to contain many idle spaces here and there. When recording data on such a disc, the MD recorder distributes the data of a single track in many locations. When such separated sections increase, "DISC FULL" may be displayed during recording.
The JOIN operation is not possible.	When a section below 8 seconds is created by separation, the track containing it cannot be joined with another track using the JOIN function, and the remaining recording time does not increase even when such a section is erased. Also, the audio may be interrupted after fast forwarding or fast reversing a track recorded in separate sections.
The remaining recording time does not increase after some tracks are erased.	
Sound is interrupted after fast forward or fast reverse.	
The total of the elapsed recording time and remaining recording time is less than the available recording time indicated on the disc.	The MD always spend a continuous space of at least 2 seconds for recording data even when it is shorter than 2 seconds. When a large number of non-used spaces below 2 seconds are produced in a disc as a result of the above, the available recording time in the disc is shortened.

## Handling MDs

### MD handling precautions

#### To maintain high quality audio for a long period

Since the disc is accommodated inside a cartridge, it can be handled easily without caring about dust and dirt. However, to maintain the high audio quality for an extended period, use care in the following points.

#### Installation location

Do not install the MD in following places.

- In a place subject to direct sunlight or where the temperature rises, for example in a closed automobile. The disc may be warped and unusable in these places.
- In a bathroom or where the humidity is high. The disc may be rusted in these places.
- On a beach or sandbox. The disc surface may be scratched or damaged if grit penetrates through an opening on the cartridge.

#### Periodical maintenance

When the cartridge gets dusty or dirty, wipe with a soft, dry cloth.

#### Do not open the shutter.

The shutter is usually locked to prevent opening. Do not force to open it or the disc may be destroyed.

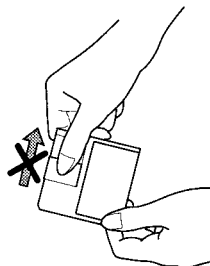

#### To protect important recording

A recordable MD has a sliding tab for protection against accidental erasure of important recording. After recording or editing, slide open the accidental erasure protect tab on the cartridge edge to make additional recording or editing impossible. If you want to re-record or edit the disc, slide the protect tab again.

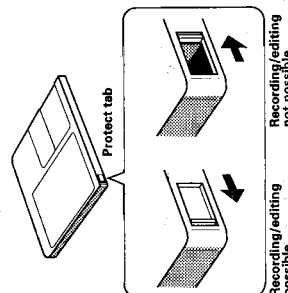

## Additional Information

### Troubleshooting

In case of difficulty, check the following before calling for service.

Symptom	Cause	Treatment
Sound is not heard.	• Cables are not connected properly.	• Connect cables properly by referring to "Connection".
	• The power cord is unplugged from the power outlet.	• Plug the power cord securely into the power outlet.
	• A playback-only MD is loaded.	• Use a recordable MD.
Recording is not possible.	• The MD is protected against accidental erasure ("DISC PROTECTED" is displayed in this case).	• Slide close the accidental erasure protect tab of the MD.
Remote control is not possible.	• The batteries are exhausted.	• Replace batteries with new ones.
	• The batteries are inserted with wrong polarity (+, -).	• Insert batteries with correct polarity.
	• There is an obstacle between the remote control unit and remote control sensor.	• Remove the obstacle.
The MD recorder power cannot be switched ON/STANDBY with POWER of the remote control unit.	• The remote control sensor is under direct sunlight.	• Screen the direct sunlight.
	• POWER is set to the amplifier/tuner mode.	• Press POWER and "10" simultaneously to set POWER to the MD recorder mode.
	• Operation is abnormal.	• Unplug the power cord, wait a few hours and plug it again.
Operation is abnormal.	• Condensation is produced inside the MD recorder immediately after starting the room heating or when it is transported from a cold to warm place.	• Unplug the power cord then plug it in again.
	• The microcomputer is malfunctioning due to external noise or lightning.	• Unplug the power cord then plug it in again.



**Specifications**

Format Minidisc digital audio system  
 Recording format Magnetic modulation overwrite format  
 Reading format Non-contacting optical method by semiconductor laser ( $\lambda=780\text{nm}$ )  
 Sampling frequency 44.1 kHz  
 Compression/expansion method ATRAC (Adaptive Transform Acoustic Coding) method  
 Number of channels 2 channels  
 Frequency Response 5 Hz to 20,000Hz ( $\pm 0.5\text{dB}$ )  
 S/N ratio 93dB  
 Dynamic range 91dB  
 Wow/flutter Less than measurable limit

Input terminals ANALOG IN (pin jack),  
 OPTICAL DIGITAL IN (square optical connector jack)  
 (Analog) Terminal name Reference input level Minimum input level  
 ANALOG IN 275mV rms. 100mV rms.

(Digital) Terminal name Received optical signal wave length Input level  
 DIGITAL IN 660nm -2.3dBm to -1.5dBm  
 1, 2

Output terminal ANALOG OUT (pin jack)  
 (Analog) Terminal name Load impedance Output level  
 ANALOG OUT 10k ohms 1.1V

Power requirements AC120V $\pm$ , 60Hz  
 Power consumption 11 watts (ON), 6 watts (STANDBY)  
 Dimensions 200 x 80 x 308.5 mm (W/H/D)  
 Mass 2.3kg (5.1 lbs)

Accessories Remote control unit (1)  
 Batteries (R03UM-4)/AAA (24F) (2)  
 Audio pin cord (2)  
 Optical digital cord (1)  
 Compu link cable (1)  
 AC power cord (1)

Specifications and appearance subject to change for improvements without prior notice.

QUALITY SERVICE  
**JVC**  
 HOW TO LOCATE YOUR JVC SERVICE CENTER  
 TOLL FREE : 1-800-537-5722

Dear customer:  
 In order to receive the most satisfaction from your purchase, read the instruction booklet before operating the unit. In the event that repairs are necessary, or for the address nearest your location, please refer to the factory service center list below or within the Continental United States. Call 1-800-537-5722 for your authorized servicer. Remember to retain your Bill of Sale for Warranty Service.  
 —JVC

**JVC SERVICE & ENGINEERING COMPANY OF AMERICA**  
 DIVISION OF US JVC CORP.

FACTORY SERVICE CENTER LOCATIONS

107 Little Falls Road Fairfield, NJ 07704-2105 (201) 808-9279	1500 Lakes Parkway Little Falls, CA 92643-5357 (770) 339-2522	705 Enterprise Street Aurora, IL 60504-8149 (630) 851-7855
5665 Corporate Avenue Cypress, CA 90630-0024 (714) 229-8011	2969 Mapunapuna Place Honolulu, HI 96819-2040 (808) 833-5828	10700 Hammerly, Suite 110 Houston, TX 77043 (713) 955-9331
230 Elcot Street Ashland, MA 0172-2377 (508) 881-5923	14505 Commerce Way Miami Lakes, FL 33016-1512 (305) 362-8252	800 Dubuque Avenue South San Francisco, CA 94080-1804 (415) 871-2666

Sophisticated electronic products may require occasional service. Just as quality is a keyword in the engineering and production of the wide array of JVC products, service is the key to maintaining the high level of performance for which JVC is world famous. The JVC service and engineering organization stands behind our products.

NATIONAL HEADQUARTERS  
**JVC SERVICE & ENGINEERING COMPANY OF AMERICA**  
 DIVISION OF US JVC CORP.  
 107 Little Falls Road  
 Fairfield, NJ 07004-2105

**If you ship the product . . .**

Pack your JVC unit in the original carton or one of equivalent size and strength. Enclose with the unit, a letter stating the problem or symptom that exists and also a copy of the receipt or bill of sale you received when you purchased your JVC unit. Print your home return address on the outside and the inside of the carton. Send to the appropriate JVC Factory Service Center as listed above.

**Don't service it yourself.**

**CAUTION**

To prevent electrical shock, do not open the cabinet. No user serviceable parts inside.  
 Refer servicing to qualified service personnel.

**ACCESSORIES**

To purchase accessories for your JVC product, you may contact your local JVC Dealer.  
 Or from the 48 Continental United States call toll free : 800-882-2345

# JVC LIMITED WARRANTY AUDIO-1

JVC COMPANY OF AMERICA warrants this product and all parts thereof, except as set forth below, ONLY TO THE ORIGINAL PURCHASER AT RETAIL TO BE FREE FROM DEFECTIVE MATERIAL AND WORKMANSHIP from the date of original retail purchase for the period as shown below. ("The Warranty Period.")

PARTS	LABOR
1YR	1YR

THIS LIMITED WARRANTY IS VALID ONLY IN THE FIFTY(50) UNITED STATES, THE DISTRICT OF COLUMBIA AND IN COMMONWEALTH OF PUERTO RICO.

### WHAT WE WILL DO:

If this product is found to be defective, JVC will repair or replace defective parts at no charge to the original owner. Such repair and replacement services shall be rendered by JVC during normal business hours at JVC authorized service centers. Parts used for replacement are warranted only for the remainder of the Warranty Period. All products and parts thereof may be brought to a JVC authorized service center on a carry-in basis except for Television sets having a screen size 25 inches and above which are covered on an in-home basis.

### WHAT YOU MUST DO FOR WARRANTY SERVICE:

Return your product to a JVC authorized service center with a copy of your bill of sale. For your nearest JVC authorized service center, see the back of this warranty at toll free: (800)557-5722. If service is not available locally, box the product carefully, preferably in the original carton, and ship, insured, with a copy of your bill of sale plus and letter of explanation of the problem to the nearest JVC Factory Service Center, the name and location of which will be given to you by the toll-free number. If you have any questions concerning your JVC Product, please contact our Customer Relations Department.

### WHAT IS NOT COVERED:

- This limited warranty provided by JVC does not cover:
  - Products which have been subject to accident, tampering, alteration, modification, negligence, misuse, faulty installation, or other abuse; or products which are repaired or serviced by anyone other than a service facility authorized by JVC to render such services; or if affixed to any attachment not provided with the products, or if the model or serial number has been altered, tampered with, defaced or removed;
  - Initial installation and installation and removal for repair;
  - Operational adjustments covered in the Owner's Manual, normal maintenance, video and audio head cleaning;
  - Damage that occurs in shipment, due to act of God, and cosmetic damage;
  - Signal reception problems and failures due to line power surge;
  - Video Pick-up Tubes/CCD Image Sensor, Cartridge, Stylus(Needle) are covered for 90 days from the date of purchase;
  - Accessories;
  - Batteries (except the Rechargeable Batteries are covered for 90 days from the date of purchase);

There are no express warranties except as listed above.  
THE DURATION OF ANY IMPLIED WARRANTIES, INCLUDING THE IMPLIED WARRANTY OF MERCHANTABILITY, IS LIMITED TO THE DURATION OF THE EXPRESS WARRANTY HEREIN.

JVC SHALL NOT BE LIABLE FOR THE LOSS OF USE OF THE PRODUCT, INCONVENIENCE, LOSS OR ANY OTHER DAMAGES, WHETHER DIRECT, INCIDENTAL OR CONSEQUENTIAL (INCLUDING, WITHOUT LIMITATION, DAMAGE TO TAPES, RECORDS OR DISCS) RESULTING FROM THE USE OF THIS PRODUCT. THE WARRANTIES OF MERCHANTABILITY AND FITNESS FOR PARTICULAR PURPOSE, ARE LIMITED TO THE WARRANTY PERIOD SET FORTH ABOVE.

Some states do not allow the exclusion of incidental or consequential damages or limitations on how long an implied warranty last, so these limitations or exclusions may not apply to you. This warranty gives you specific legal rights and you may also have other rights which vary from state to state.

JVC COMPANY OF AMERICA  
DIVISION OF US JVC CORP.  
41 Slater Drive  
Einwood Park, New Jersey 07407

REFURBISHED PRODUCTS CARRY A SEPARATE WARRANTY. THIS WARRANTY DOES NOT APPLY FOR DETAILS OF REFURBISHED PRODUCT WARRANTY. PLEASE REFER TO THE REFURBISHED PRODUCT WARRANTY INFORMATION PACKAGED WITH EACH REFURBISHED PRODUCT.

For customer use:  
Enter below the Model No. and Serial No. which is located either on the rear, bottom or side of the cabinet. Retain this information for future reference.

Model No.: \_\_\_\_\_ Serial No.: \_\_\_\_\_  
Purchase date: \_\_\_\_\_ Name of dealer: \_\_\_\_\_



VICTOR COMPANY OF JAPAN LIMITED

# Location of Main Part

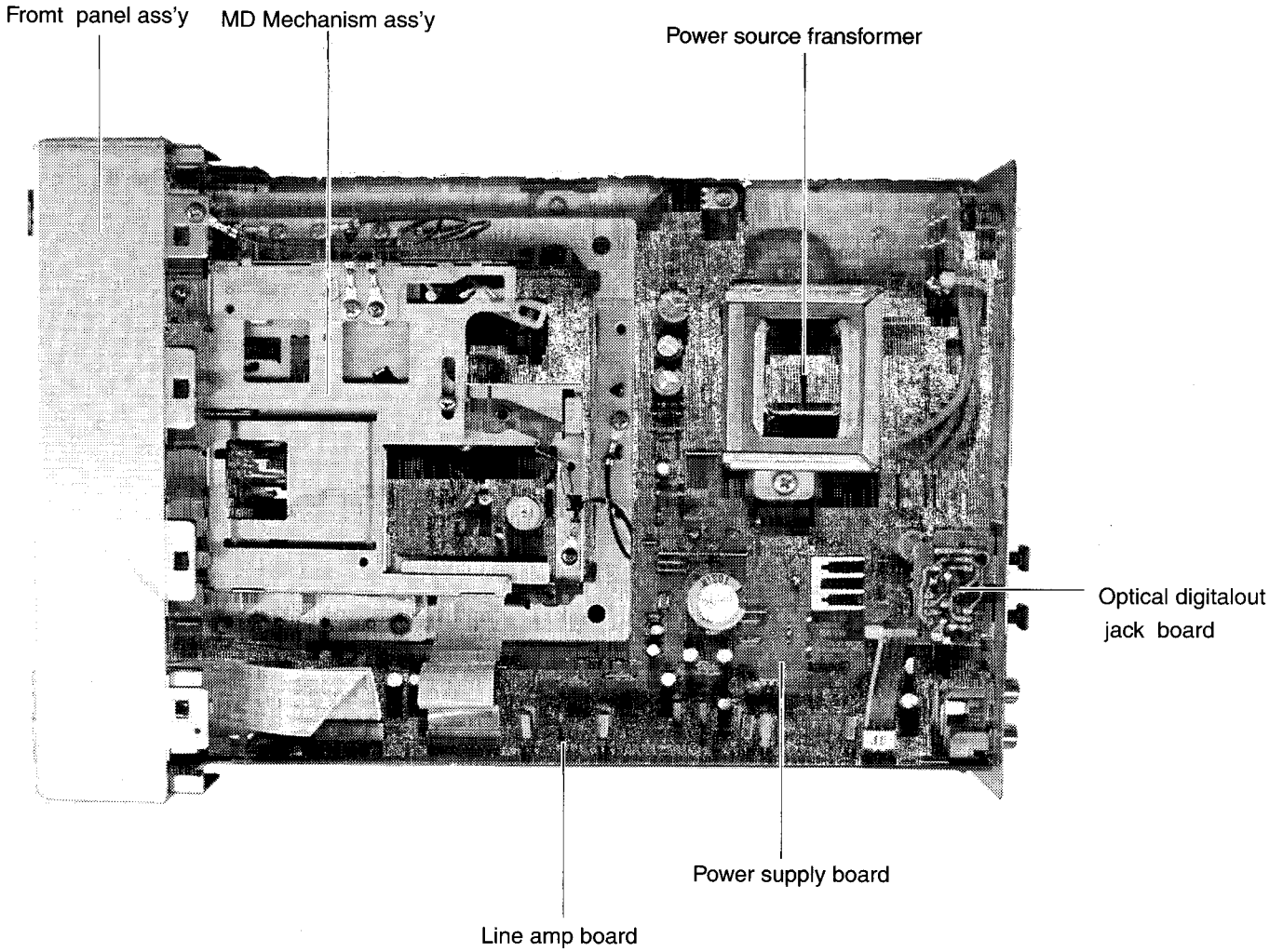

Fig.1-1

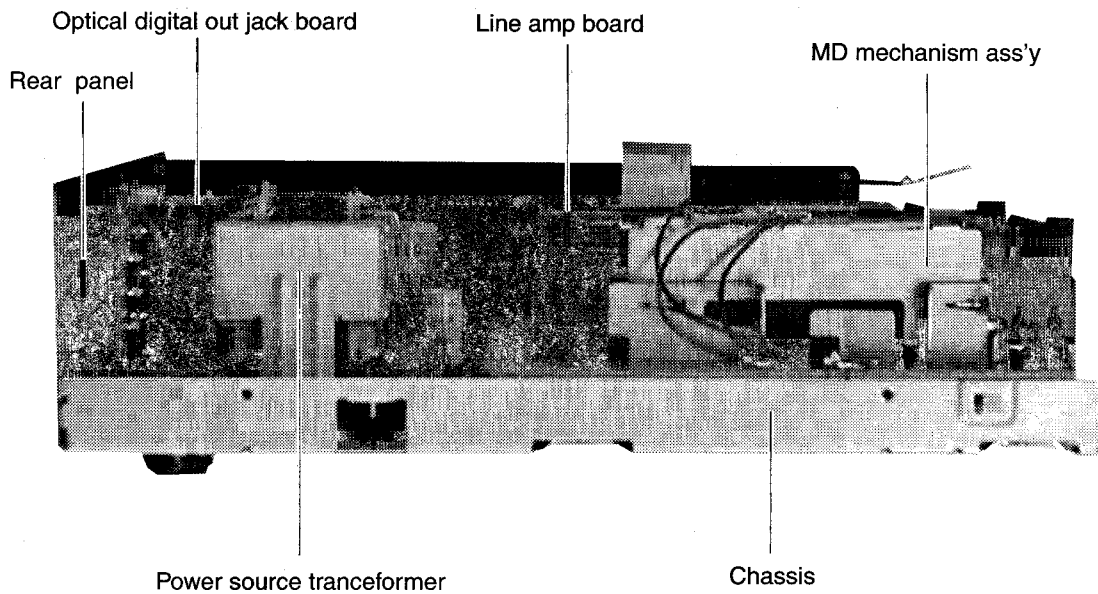
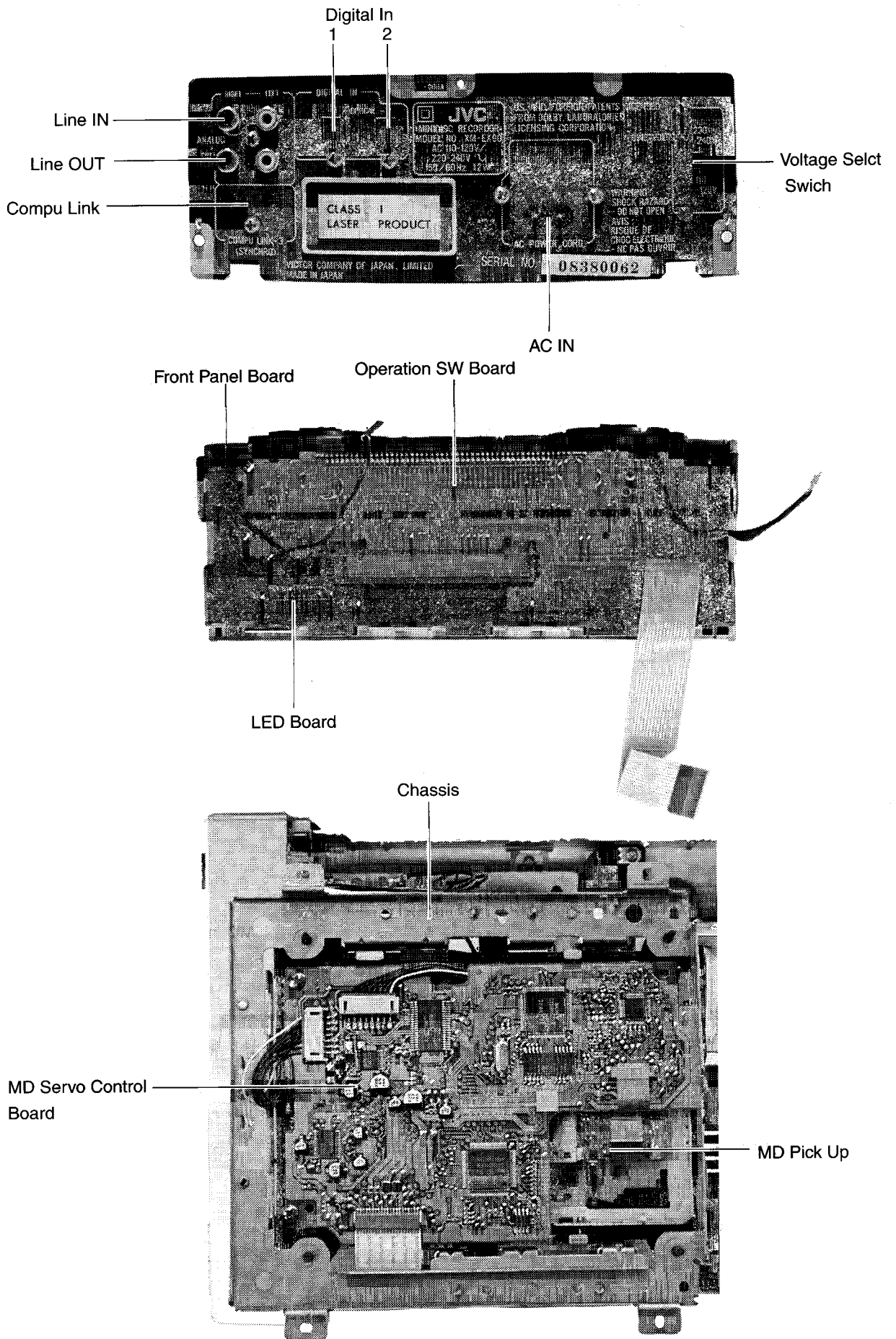

Fig. 1-2



# Removal of Main Parts

## ■ Removing the top cover(See Figs.1-3)

- (1) From both sides of the body, remove the two screws ① retaining the top cover (See Figs. 1 and 2).
- (2) From behind the body, remove the three screws ② retaining the top cover (See Fig.3).
- (3) Remove the top cover by spreading the feet on both sides of cover outward and raising the feet.

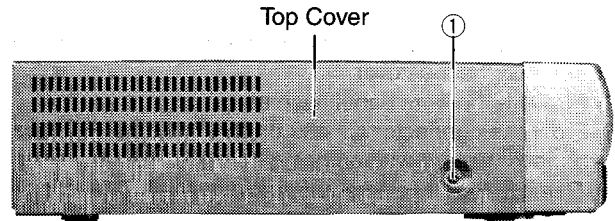

Fig.2-1

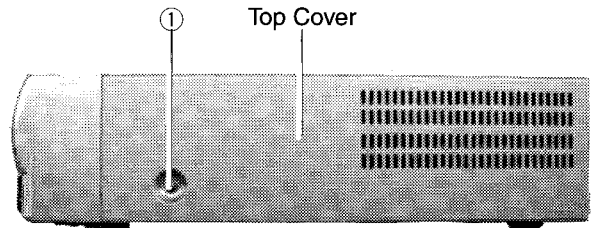

Fig.2-2

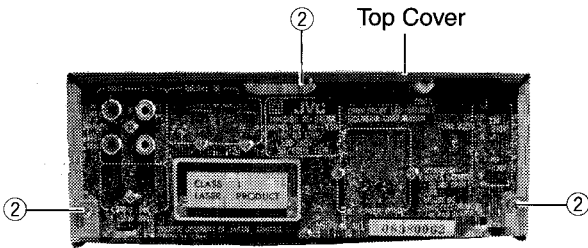

Fig.2-3

## ■ Removing the front panel assembly (See Figs. 4-7)

- (1) After turning the body upside down, remove the two screws ③ retaining the front panel assembly (See Fig.4).
- (2) Disengage the one engagement A fixing the front panel assembly (See Fig.4)
- (3) From both sides of the body, disengage the two engagements B fixing the panel assembly (See figs. 5 and 6).
- (4) remove the two screws ④ retaining the Lug wire (See Fig. 7).
- (5) JFrom the connector CN201 on the line amp. P.C. board, remove the card wire outgoing from the front panel assembly (See Fig. 7).
- (6) from the connector CN103 on the line ammp.P.C. board, rear, remove the connector wire outgoing from the front panel assembly (See Fig.7).
- (7) Remove the front panel assembly.

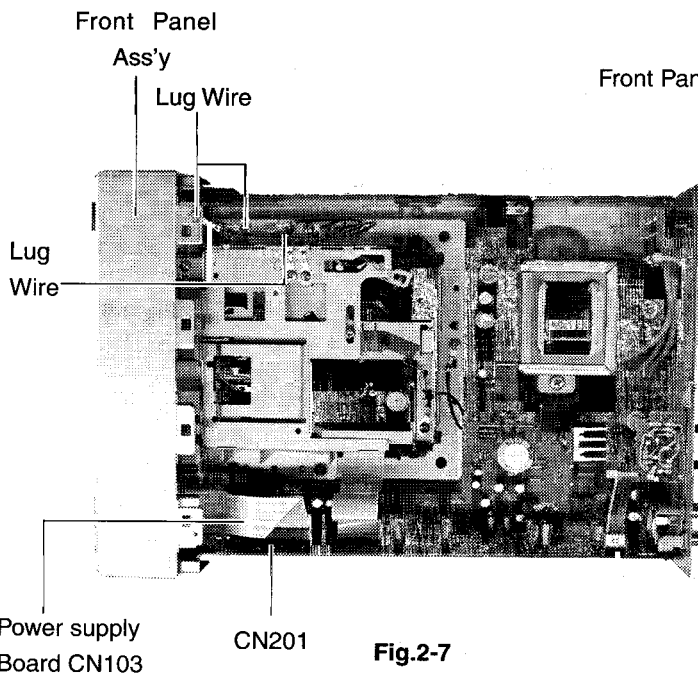
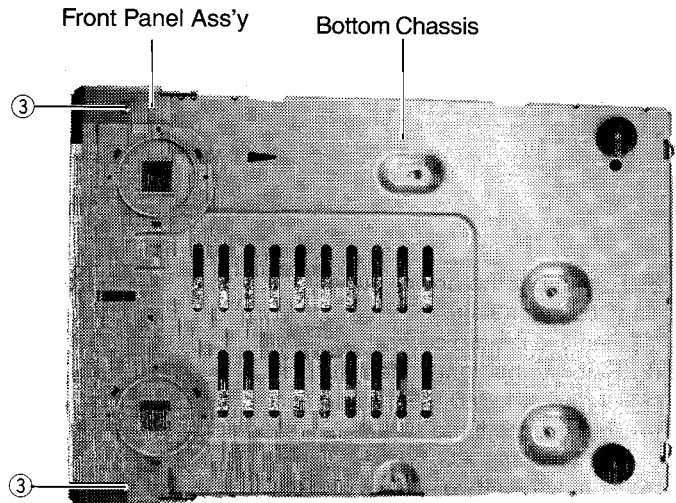

Fig.2-5

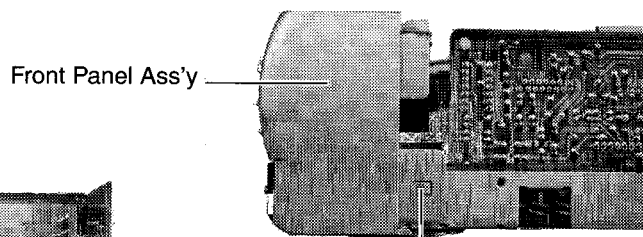

Fig.2-6

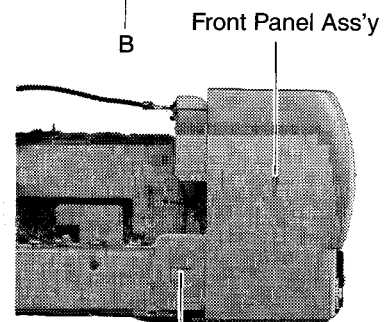

Fig.2-7

■ Removing the MD mechanism assembly (See Fig. 8).

- (1) Remove the top cover.
- (2) Remove the front panel assembly.
- (3) Front the connector CN489 on the line amp. P.C. board remove the card wire outgoing from the MD mechanism.
- (4) Remove the three screws 5 retaining the MD mechanism assembly.
- (5) Take out the MD mechanism Assembly.

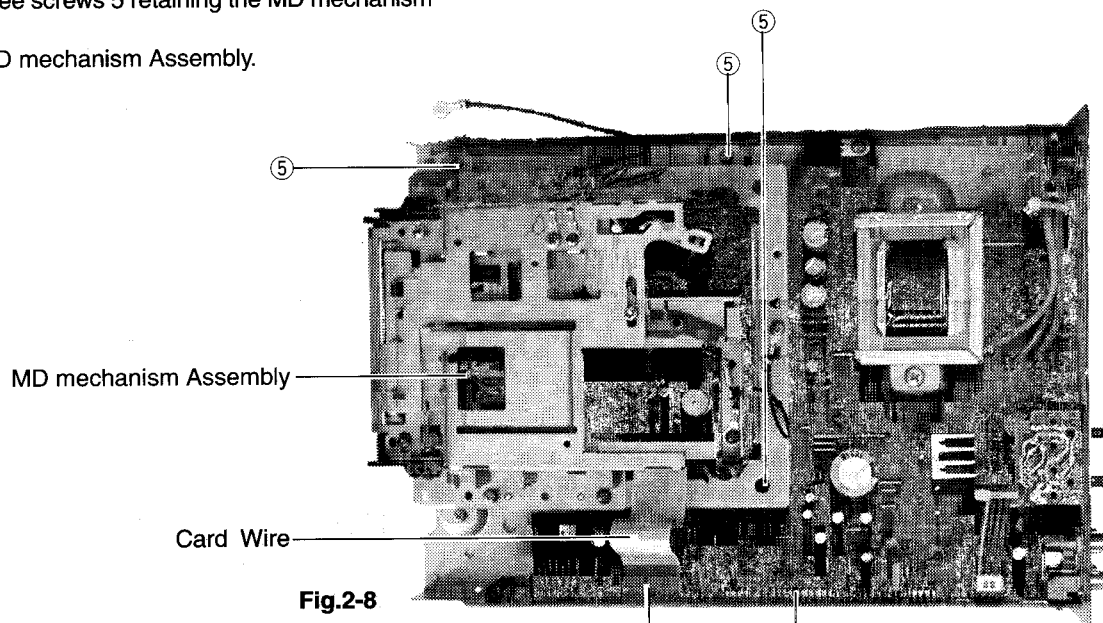

Fig.2-8

■ Removing the power supply and line amp. P.C. board (See Figs. 9 and 10)

- (1) Remove the top cover.
- (2) Remove the front panel assembly.
- (3) Remove the MD mechanism assembly.
- (4) Remove the three screws (6) retaining the power supply and line amp. P.C. board.
- (5) Remove the two screws (7) retaining the power supply trans.
- (6) From behind the body, remove the one screw (8) retaining the power supply and line amp. P.C. board.

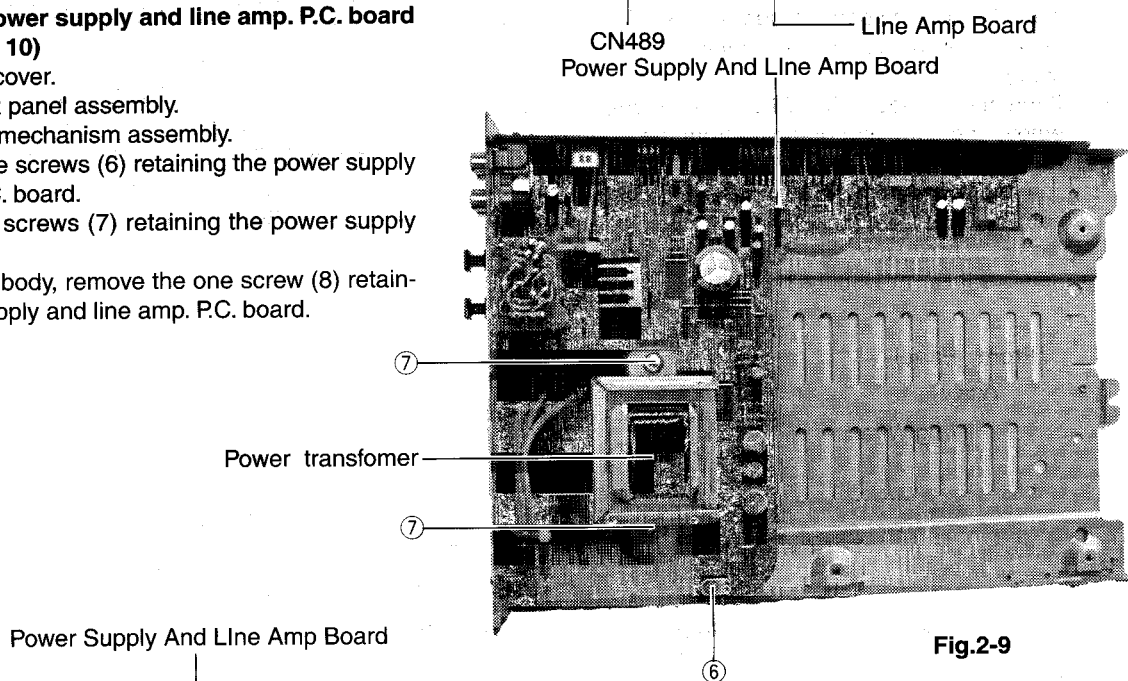

Fig.2-9

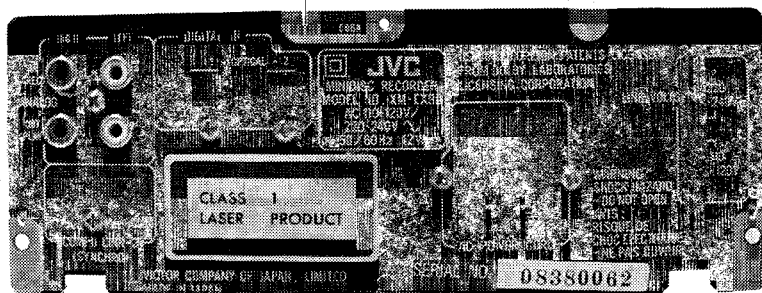

Fig.2-10

■ Removing the rear panel (See Fig. 10)

- (1) Remove the top cover.
- (2) Remove the front panel assembly.
- (3) Remove the MD mechanism assembly.
- (4) Remove the power supply and line amp. P.C. board.
- (5) Remove the six screws ⑨ retaining the rear panel.

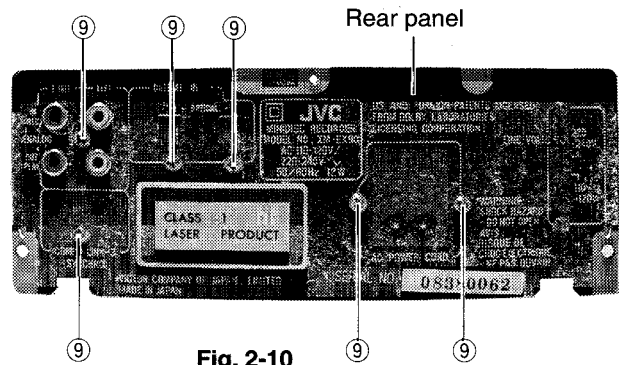

Fig. 2-10

■ Removing the operating switch P.C. board (See Fig. 11,12)

- (1) Remove the top cover.
- (2) Remove the front panel assembly.
- (3) Remove the four screws ⑩ retaining the operating switch P.C. board.
- (4) Together with the wire clamp, remove the two screws ⑪ retaining the LED P.C. board.
- (5) Dismount the operating switch P.C. board together with the LED P.C. board.

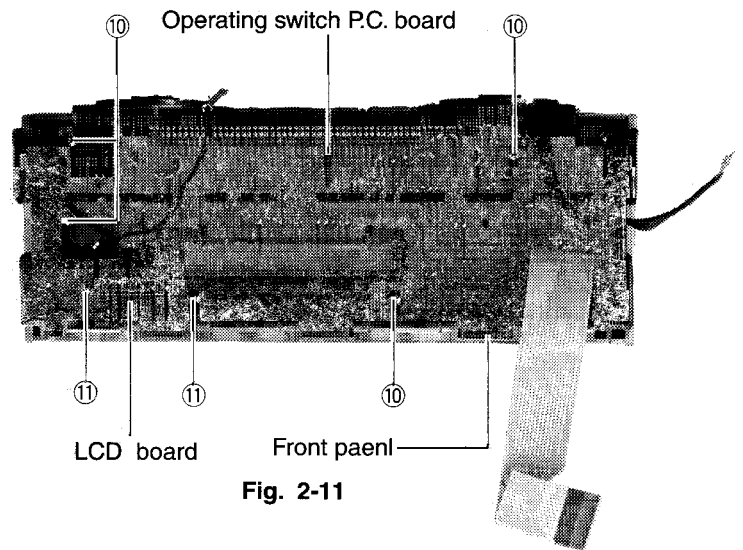

Fig. 2-11

■ Removing the front cover (see Figs. 12 and 13)

- (1) Remove the top cover.
- (2) Remove the front panel assembly.
- (3) Remove the operating switch P.C. board.
- (4) Disengage the four engagements C fixing the front cover (See Fig. 12).
- (5) Disengage the two engagements D fixing the front cover and take out the cover from the front panel (See Fig. 13).

CAUTION: Since the operating button, LED lens and so forth provided inside the front panel assembly will be removed easily, be sure to handle these parts so carefully as not to lose any of these parts.

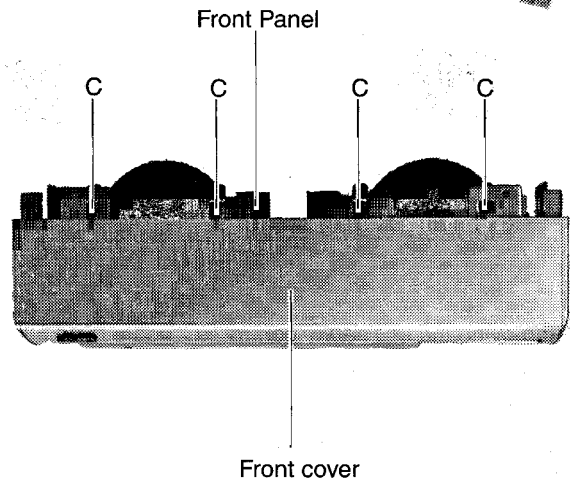

Fig. 2-12

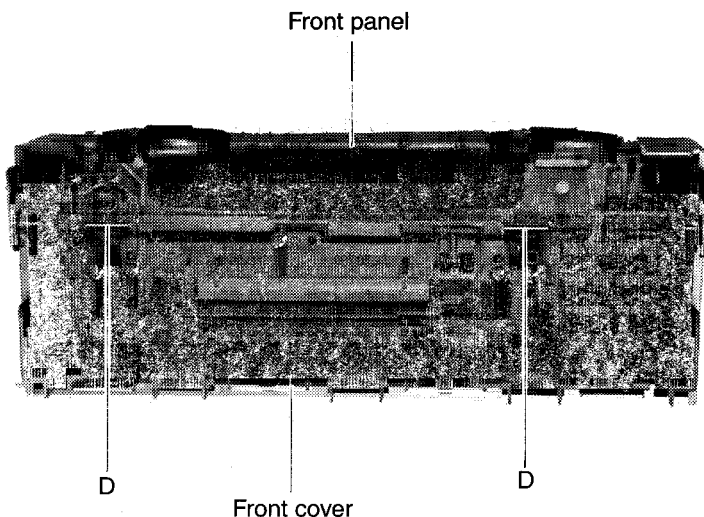

Fig.2-13

■ Removing the MD mechanism (See Figs. 14 - 16)

- (1) Remove the top cover.
- (2) Remove the front panel assembly.
- (3) Remove the MD mechanism assembly.
- (4) Remove the two screws ⑫ retaining the side bracket.
- (5) Dismount the side bracket.
- (6) Remove the three lug wire set screws ⑬ connecting the MD mechanism assembly and chassis (See Figs. 14 - 16).
- (7) Remove the four dampers fixing the MD mechanism assembly (See Fig. 14).
- (8) Remove the take out the MD mechanism from the two engagements E on the left side chassis (See Fig. 15).

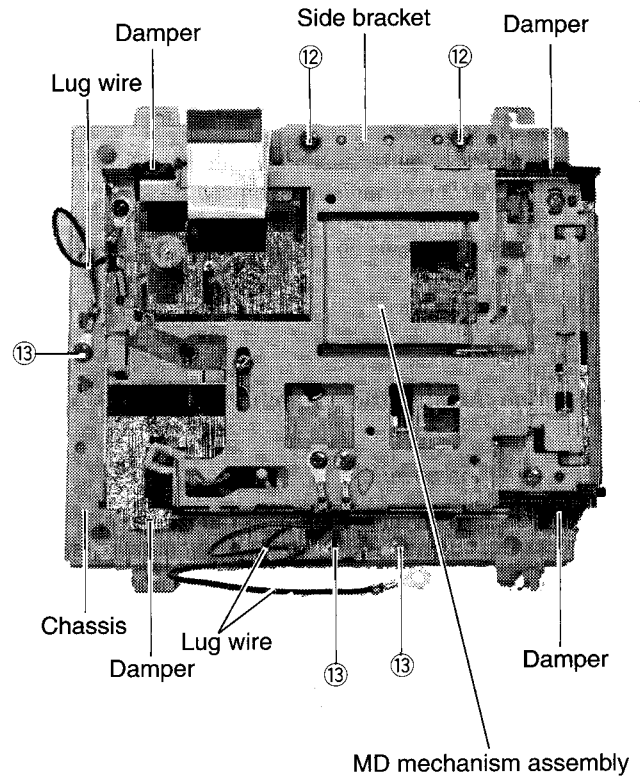
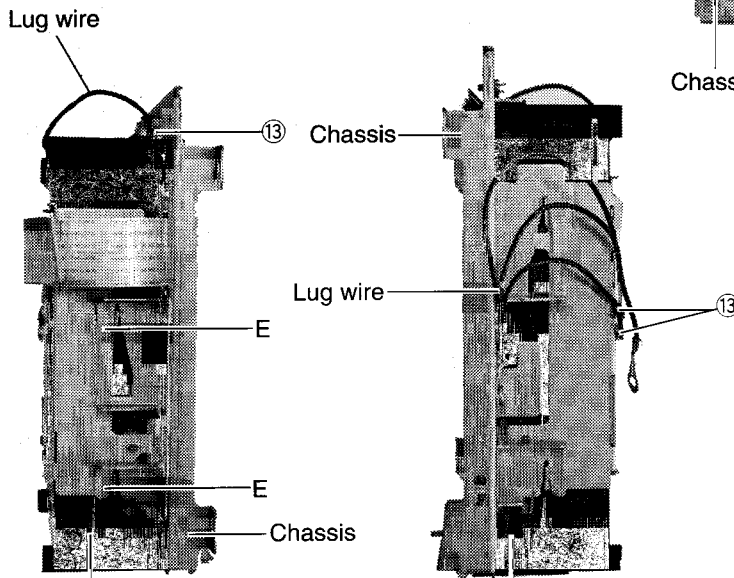

Fig. 2-14



ME mechanism assembly

Fig. 2-15

MD mechanism assembly

Fig. 2-16

■ Removing the MD servo control P.C. board (See Fig. 17)

- (1) Remove the top cover.
- (2) Remove the front panel assembly.
- (3) Remove the MD mechanism assembly.
- (4) Remove the MD mechanism.
- (5) Remove the two screws ⑭ retaining the MD servo control P.C. board.
- (6) Disconnect the flexible wire from the connector CN321 on the MD servo control P.C. board.
- (7) Disconnect the connector wires from the connectors CN407 and CN408 on the MD servo control P.C. board.
- (8) Disengage the engagement F fixing the MD servo control P.C. board and take out the MD mechanism.

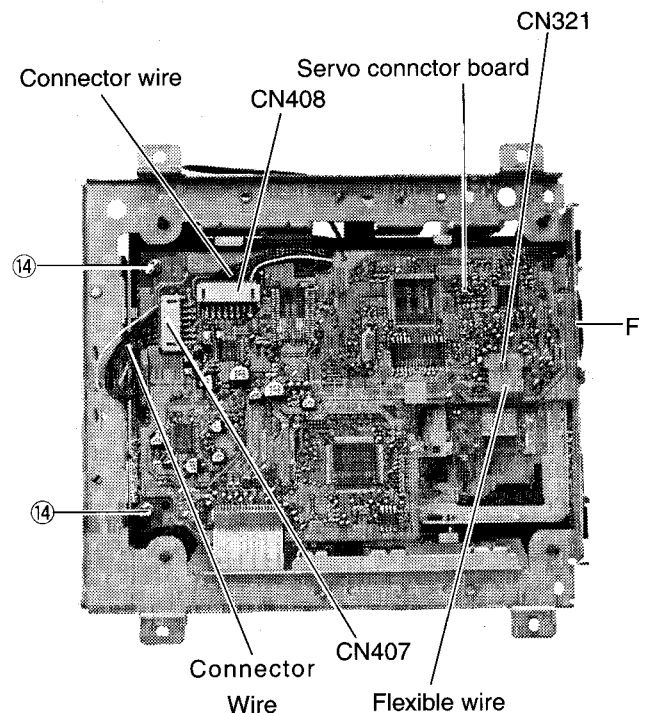
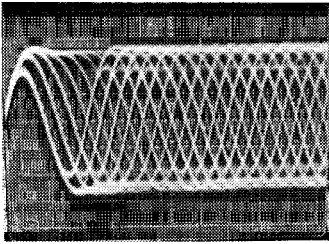

Fig. 2-17





RF signal waveform of premastered disc



0.2V/div. 0.5msec./div.

RF signal waveform of recordable disc

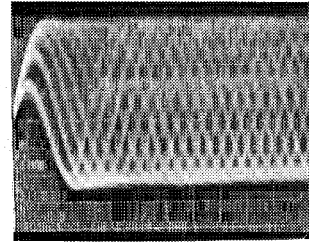

0.2V/div. 0.5msec./div.

#### 4. Test mode releasing method

After completion of the above confirmation, draw out the AC receptacle and release the test mode (When any key other than specified above has been pressed prior to drawing out the AC receptacle, it may sometimes be impossible to perform correct adjustment).

# General Flow until Reading TOC (MD Section)

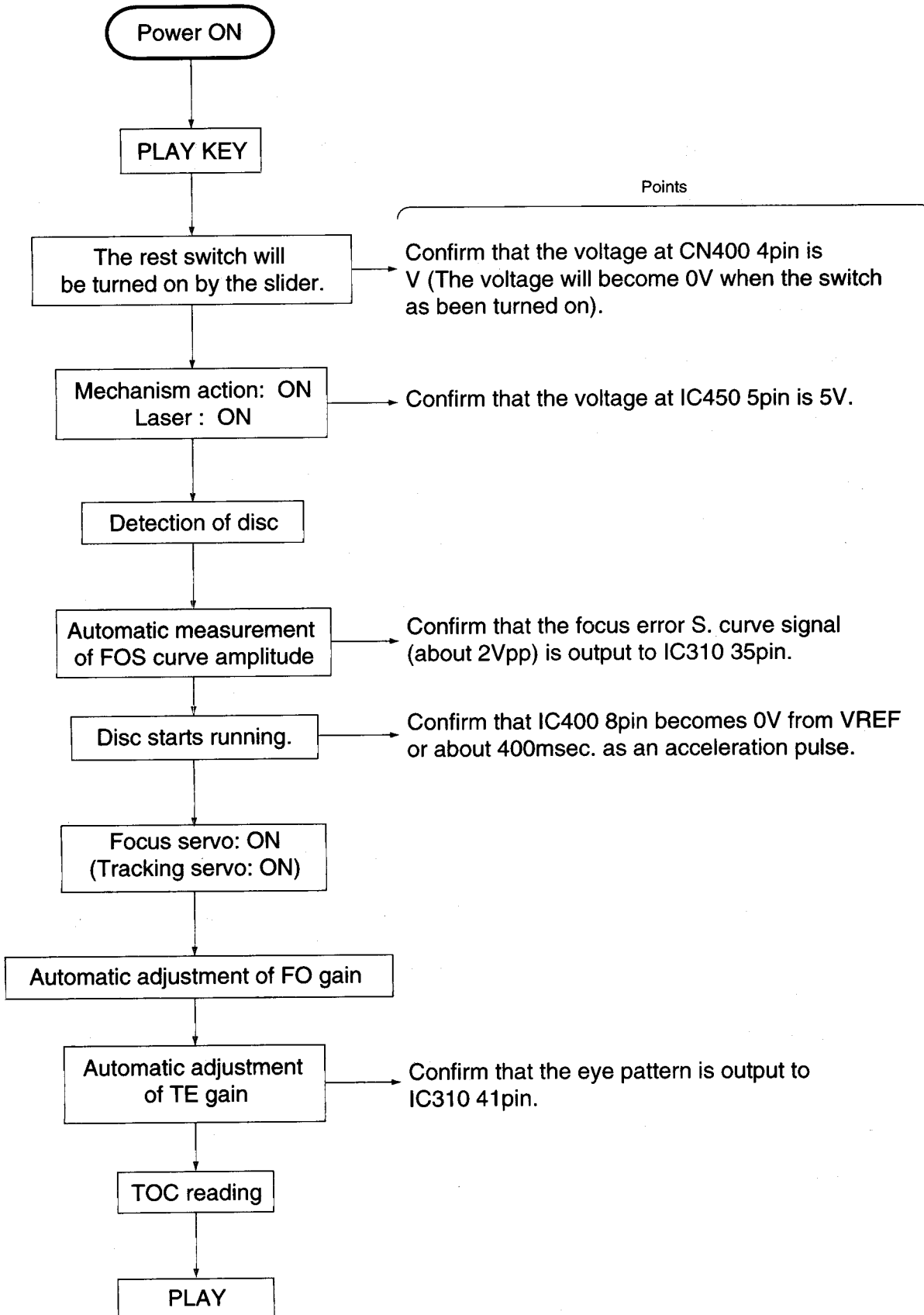

## Maintenance of MD Pickup

### (1) Cleaning of pickup lens

- 1) Prior to changing the pickup, clean the pickup lens.
- 2) For cleaning the lens, use the following cotton swab after immersing it in alcohol.

Product No. JCB-B4; Manufacturer: Nippon Cotton Swab

### (2) Confirmation of the service life of laser diode when the service life of the laser diode has been exhausted, the following symptoms will appear:

- 1) Recording will become impossible.
- 2) The RF output (EFM output and eye pattern amplitude) will become lower.
- 3) The drive current required for light emitting of laser diode will be increased.

Confirm the service life according to the following flow chart:

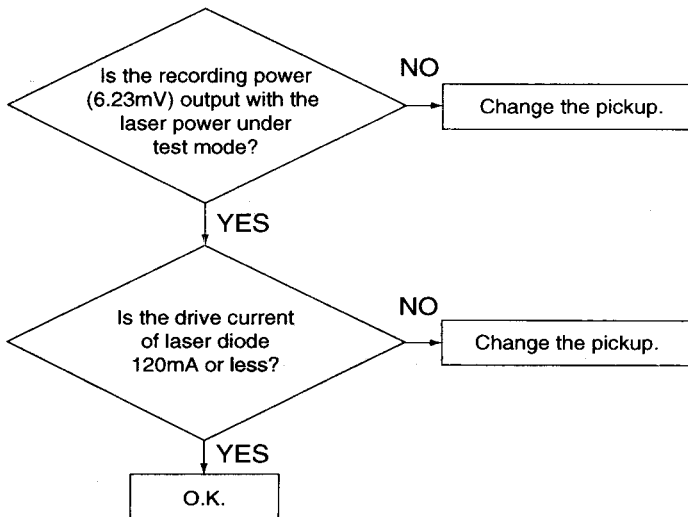

### (3) Method of measuring the drive current of laser diode

When the voltage measured at TP ILCC (Q301 emitter) and +5V (Q303 emitter) of the MD servo P.C. board (ENX-023) have become 600mV or over, the service life of the laser diode is judged to have been exhausted.

**[Caution]** When TP ILCC (Q301 collector) and +5V (Q303 emitter) have been in short circuit on such an occasion, then the laser diode will be broken. Therefore, take utmost care in handling the MD pickup.

## Procedures for Changing the MD Pickup

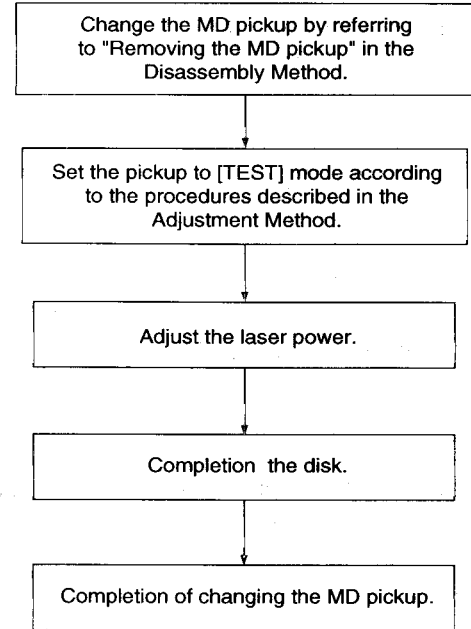

★ Since this system is designed to perform magnetic recording, the laser power ten times or over of the conventional CD player will be output. Therefore, be sure to perform not only adjustment and operation of this system so carefully as not to directly look at the laser beam or touch on the body.

### (4) Semi-solid state resistors on the APC P.C. board

The semi-solid state resistor on the APC P.C. board attached to the pickup is used for adjusting the laser power. Since these resistors should be adjusted in pair according to the characteristics of the optical block, be sure not to touch on the resistors.

Since the service life of the laser diode will be exhausted when the laser power is low, it is necessary to change the pickup. Meanwhile, do not turn the semi-solid state resistors of the normal pickup. Otherwise, the pickup will be damaged due to overcurrent.

# Procedures for repairing

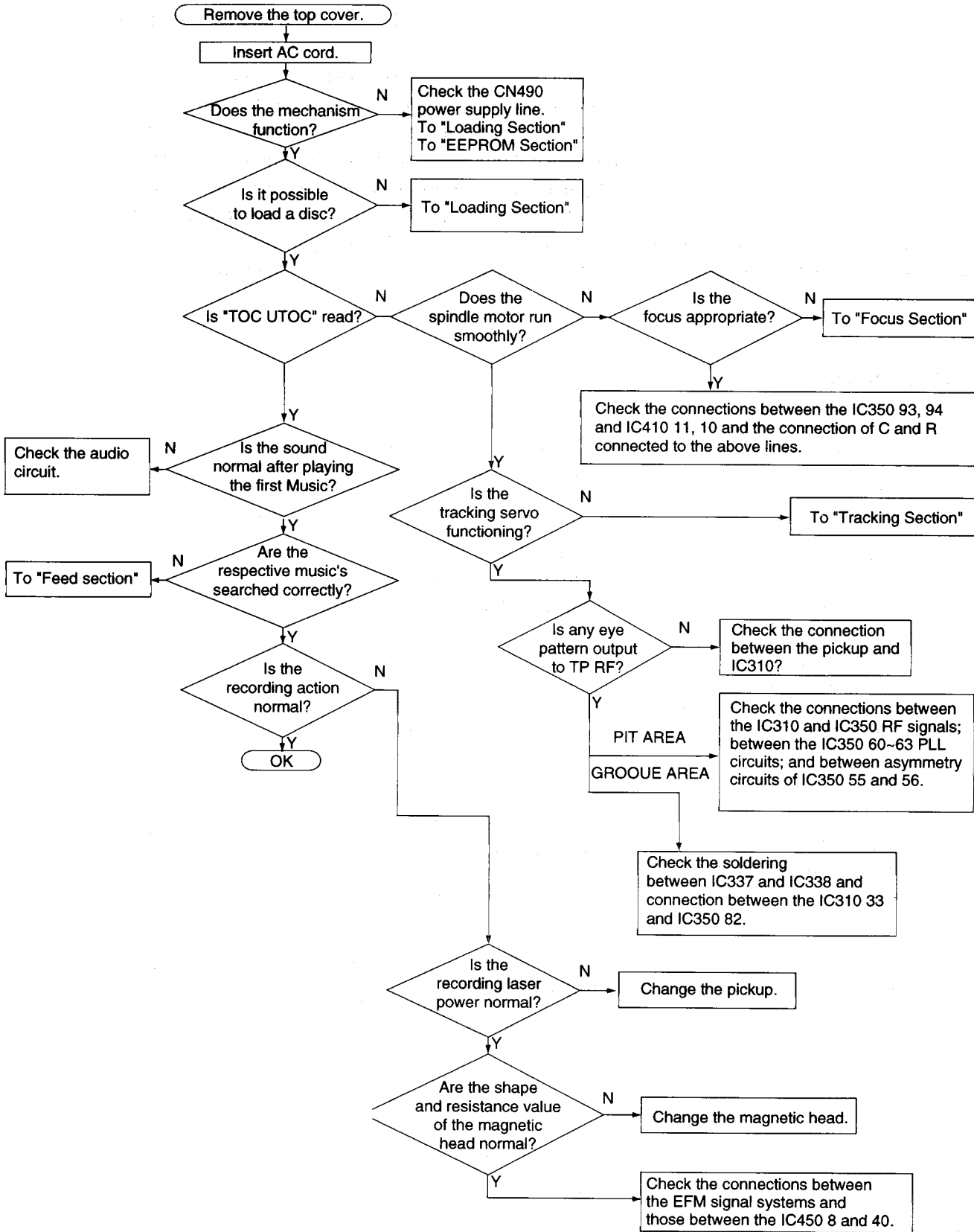

Outputs of IC450 8 and 40 when the action is normal

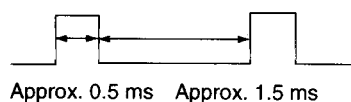

### EEPROM Section

After resetting, the microcomputer will access to EEPROM and read out all of the address values. In case the address data which have been read out at this time do not coincide with those on the microcomputer program, the EEPROM data will all be rewritten and read out once again. Should the address values read out at this time do not coincide with those on the microcomputer program, then a cycle from writing through to reading and comparison will be repeated until the values which have been read out coincide with the written values. Therefore, the program will not proceed any further. When the contents of EEPROM have been damaged or EEPROM has been replaced with a new one, this system will placed into this state. In such a case, turn of the AC power supply, and after connecting IC450 50 to GND, turn on the AC power supply. At this time, the mechanism will perform the [EJECT] action (Otherwise, repeat the adjustment steps). In case the mechanism does not perform any [EJECT] action, an electrical breakdown of EEPROM (IC453) can be considered.

### Loading Section

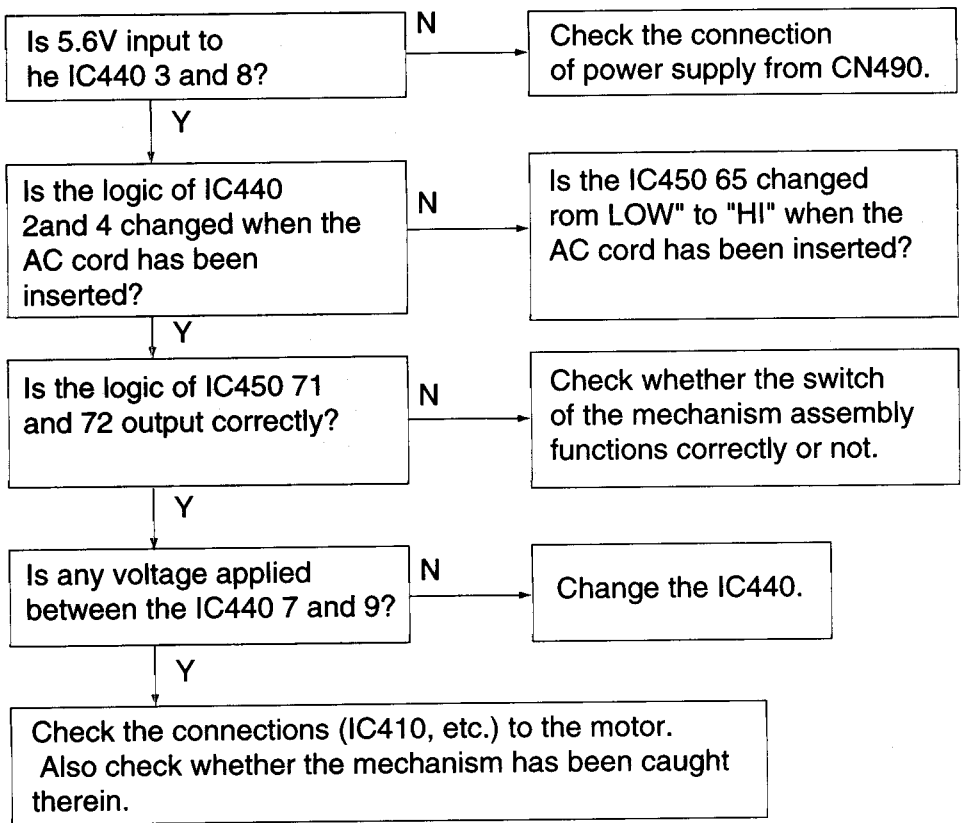

Timing of mechanism switch

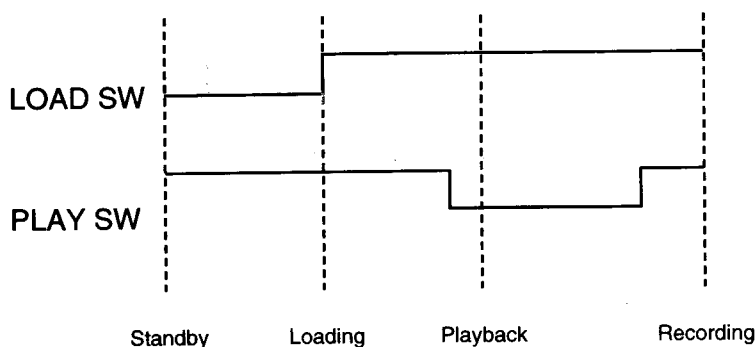

Focus Section (Prior to executing the following steps, change the source of this set to MD)

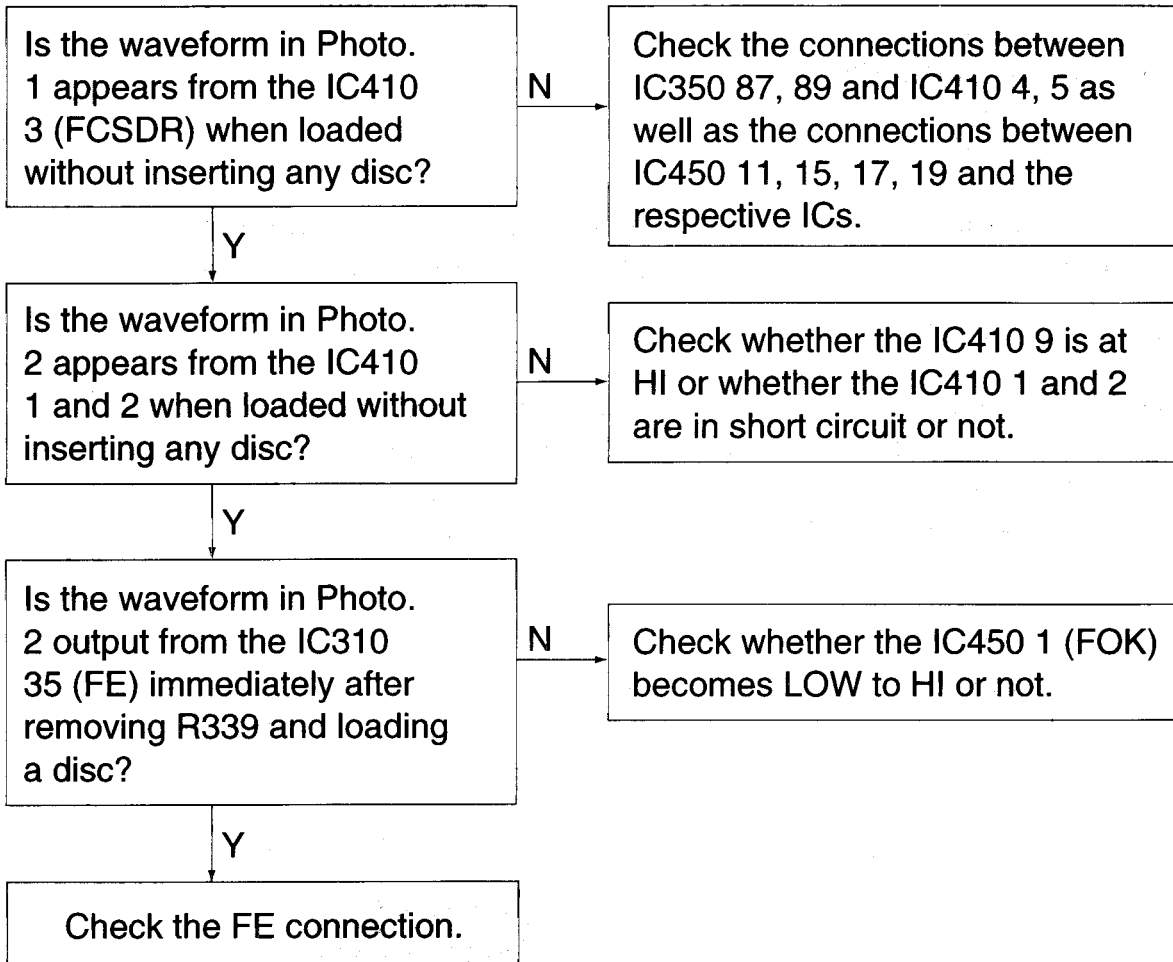
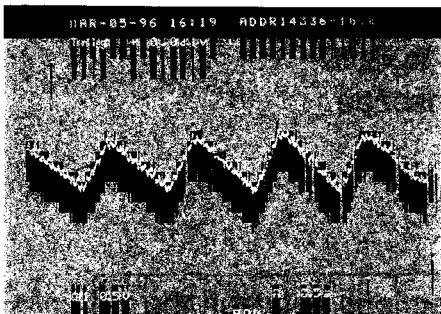
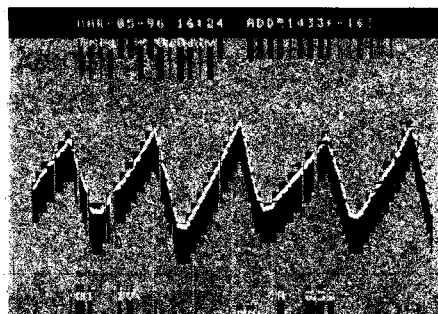

Photo. 1



Connect VC to GND of the oscilloscope.

Photo. 2



Voltage between IC401 (a) and (2)

Photo. 3

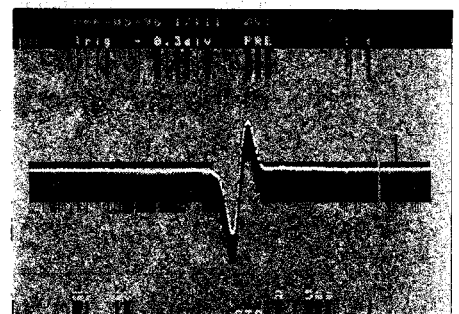

Connect VC to GND of the oscilloscope.

Tracking Section

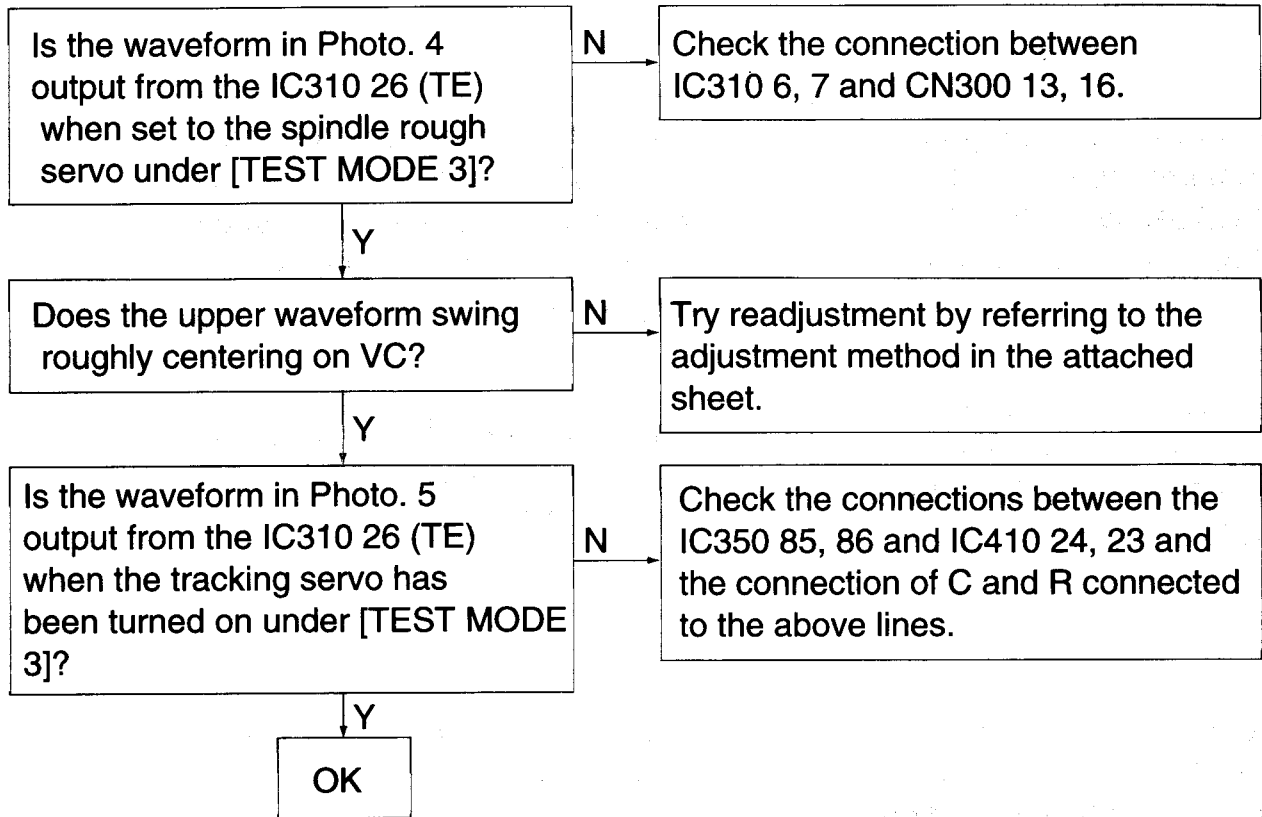
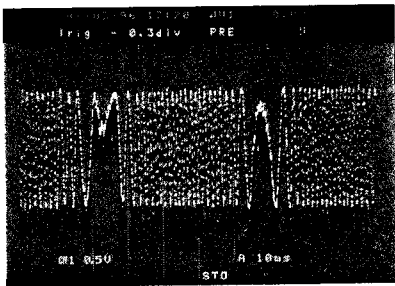
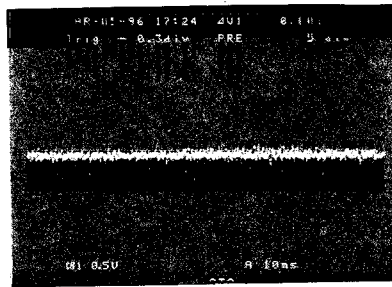

Photo. 4 (Recordable group)



Connect VC to GND of the oscilloscope.

Photo. 5 (Recordable group)



Connect VC to GND of the oscilloscope.

Feed Section

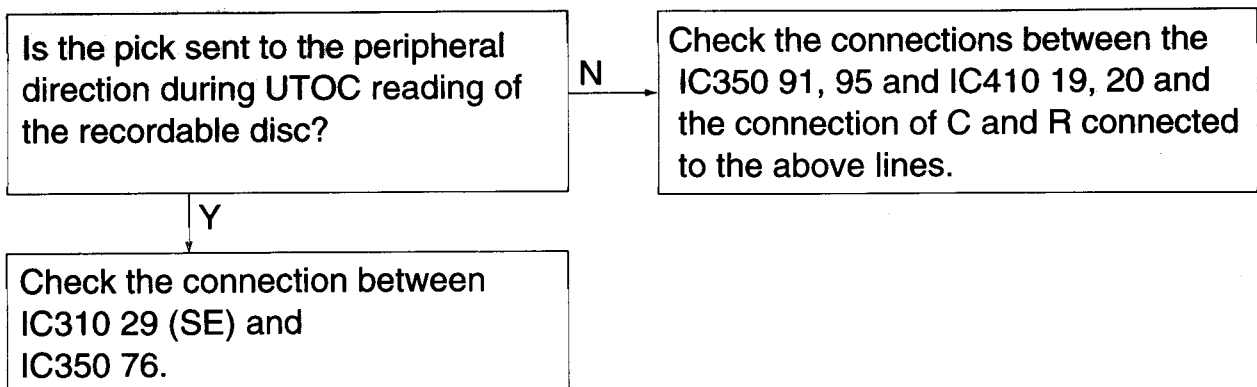



## Description of Major ICs

### ■ IC250 MN173222JABE (System controller)

Pin No.	Symbol	I/O	Function
1 - 2	Non		Not used
3 - 5	G11-G13	O	FL grid control output
6 - 28	S35-S17	O	FL segment control output
29	-Vpp	I	Power supply
30 - 45	S16-S1	O	FL segment control output
46	LED-STANDBY	O	LED-STANDBYT output
47	MDCLK	O	MD unit communication
48	MDSTAT	I	MD unit communication
49 - 52	Non		
53	MDCOM	O	MD unit communication
54	Non		
55	DVCLK	O	MD unit communication
56	DVSTB	O	MD unit communication
57	DVDATA	O	MD unit communication
58	MDREADY	O	MD communication
59	REM	I	Remocon input
60	TEST-MODE	I	TEST pin
61	DO/EXP	I	DOM/EXP function exchanged
62	POWER	O	Control for D121-D124
63	DIN-SW	O	Control for IC280
64	SMUTE1	O	System mute 1
65	SMUTE2	O	System mute 2
66	LED-GREEN	O	LED control (Green)
67	LED-RED	O	LED control (Red)
68	DCS-OUT	O	DCS out
69	DCS-IN	O	DCS input
70 - 72	Keyout 0-3	O	Key output
73 - 77	Non		
78 - 81	Key in 0-3	I	Key input
82	RST	I	Reset input
83	D. GND	I	Digital ground
84	Non		
85	D GND	I	Digital ground
86	6MHz	O	OSC output
87	6MHz	I	OSC input
88	Vcc (D +5V)	I	Power supply
89 - 98	G1-G10	O	FL grid control output
99-100	Non		

# Block Diagrams

- Flow of various signals in MD section
- (1) Playback signal

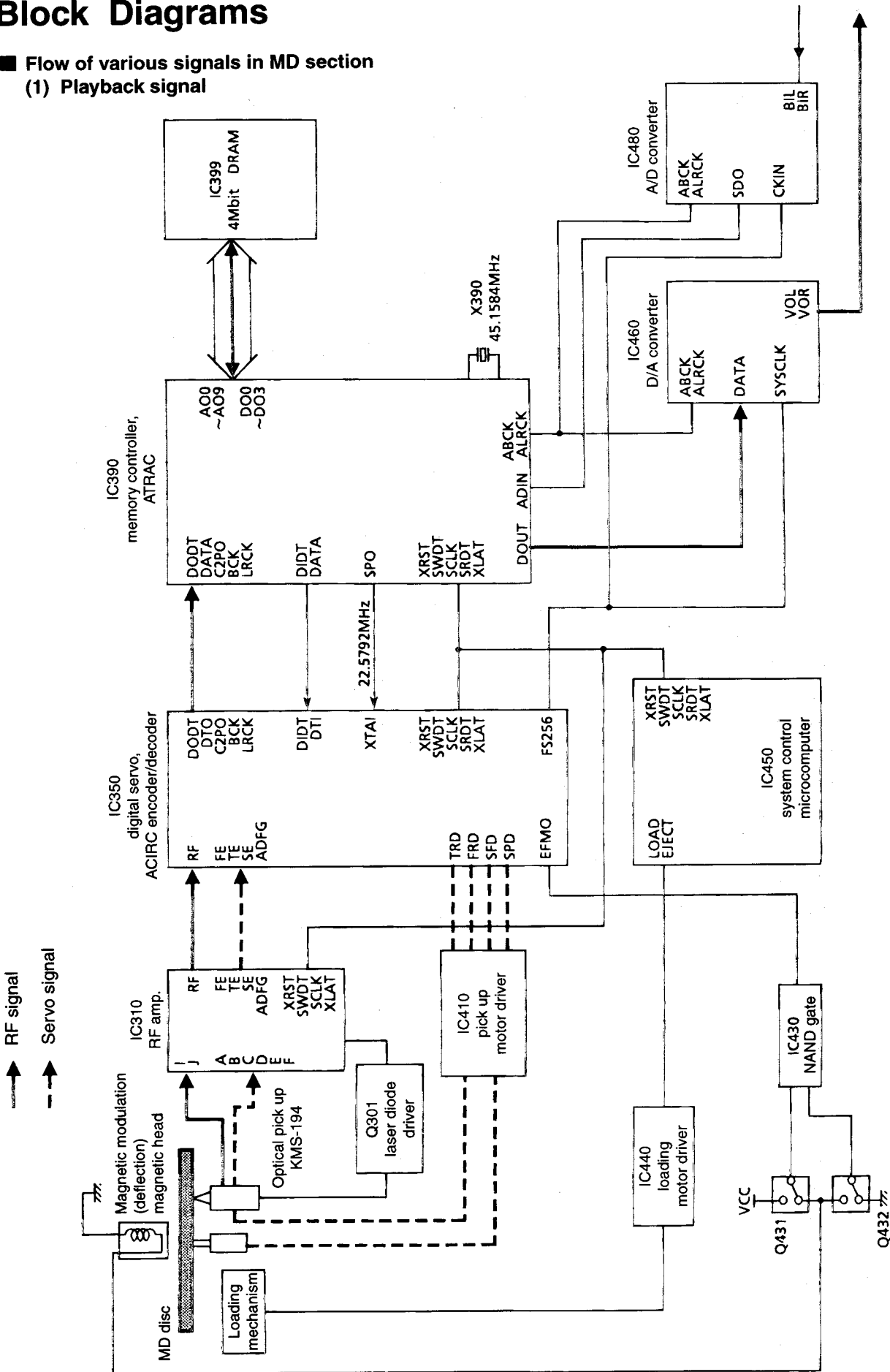

(2) Recording signal (analogue input during tuner recording)

 Recording signal  
 Servo signal

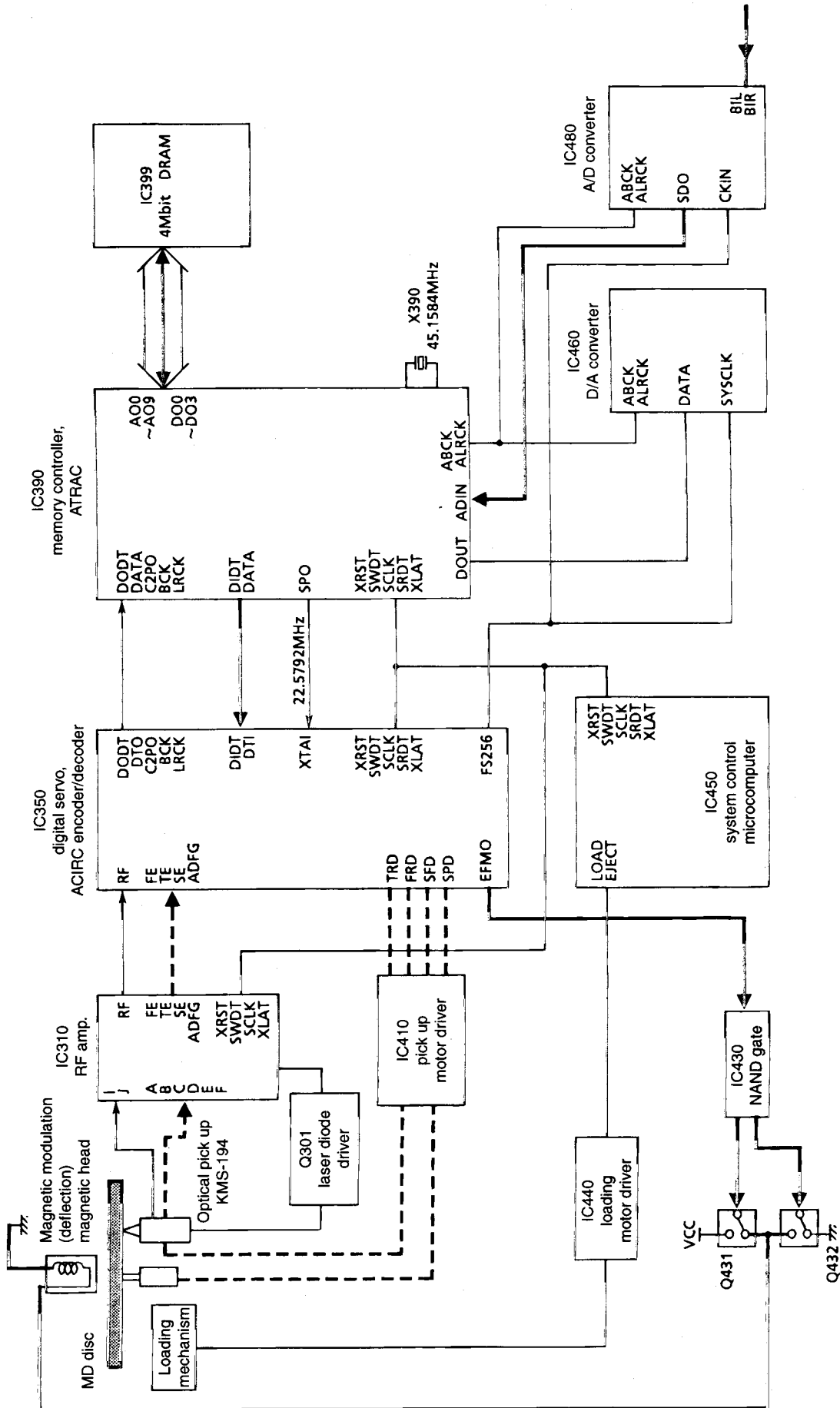

(3) Recording signal (Digital input during CD)

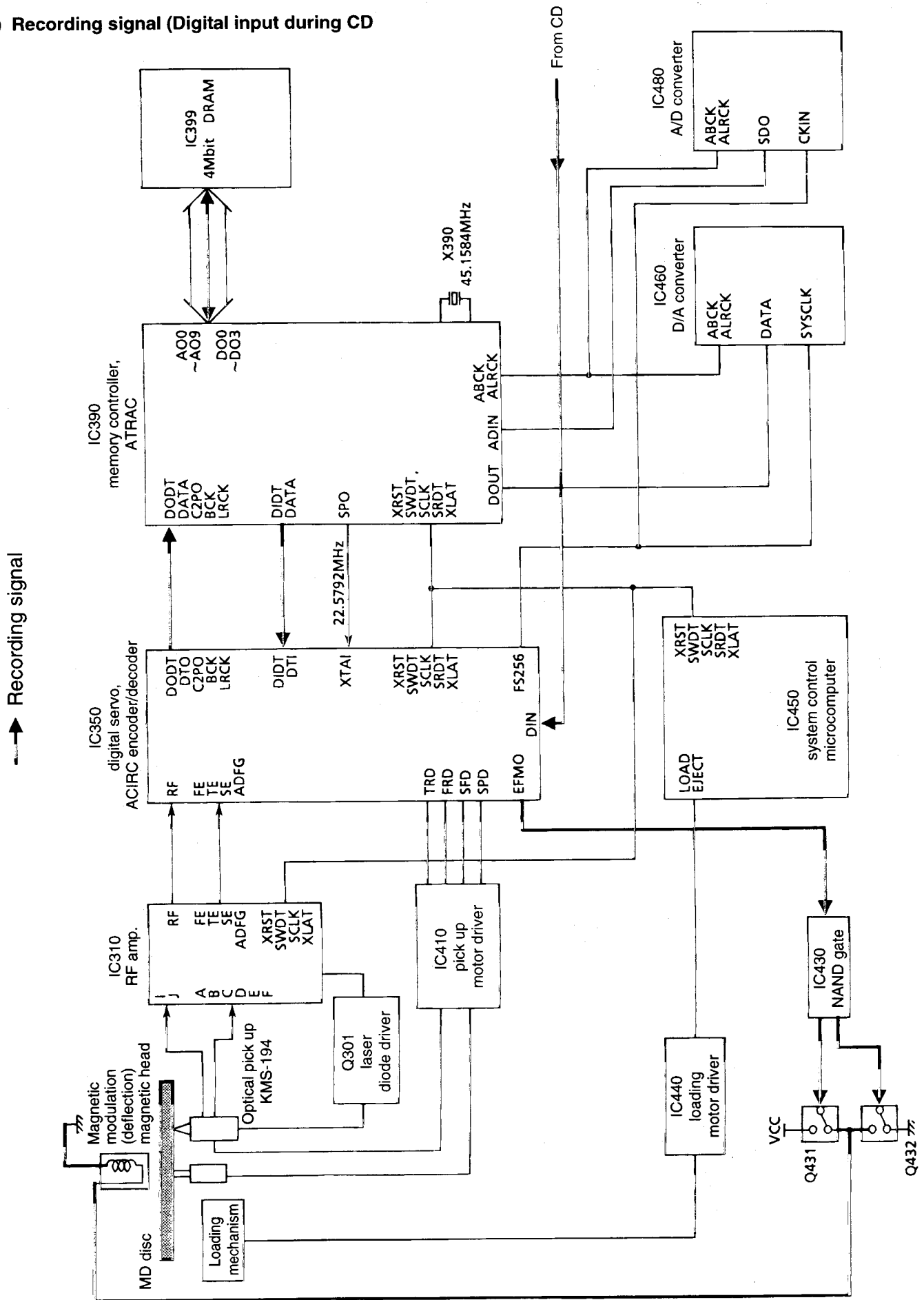

(4) Disc loading and eject signal

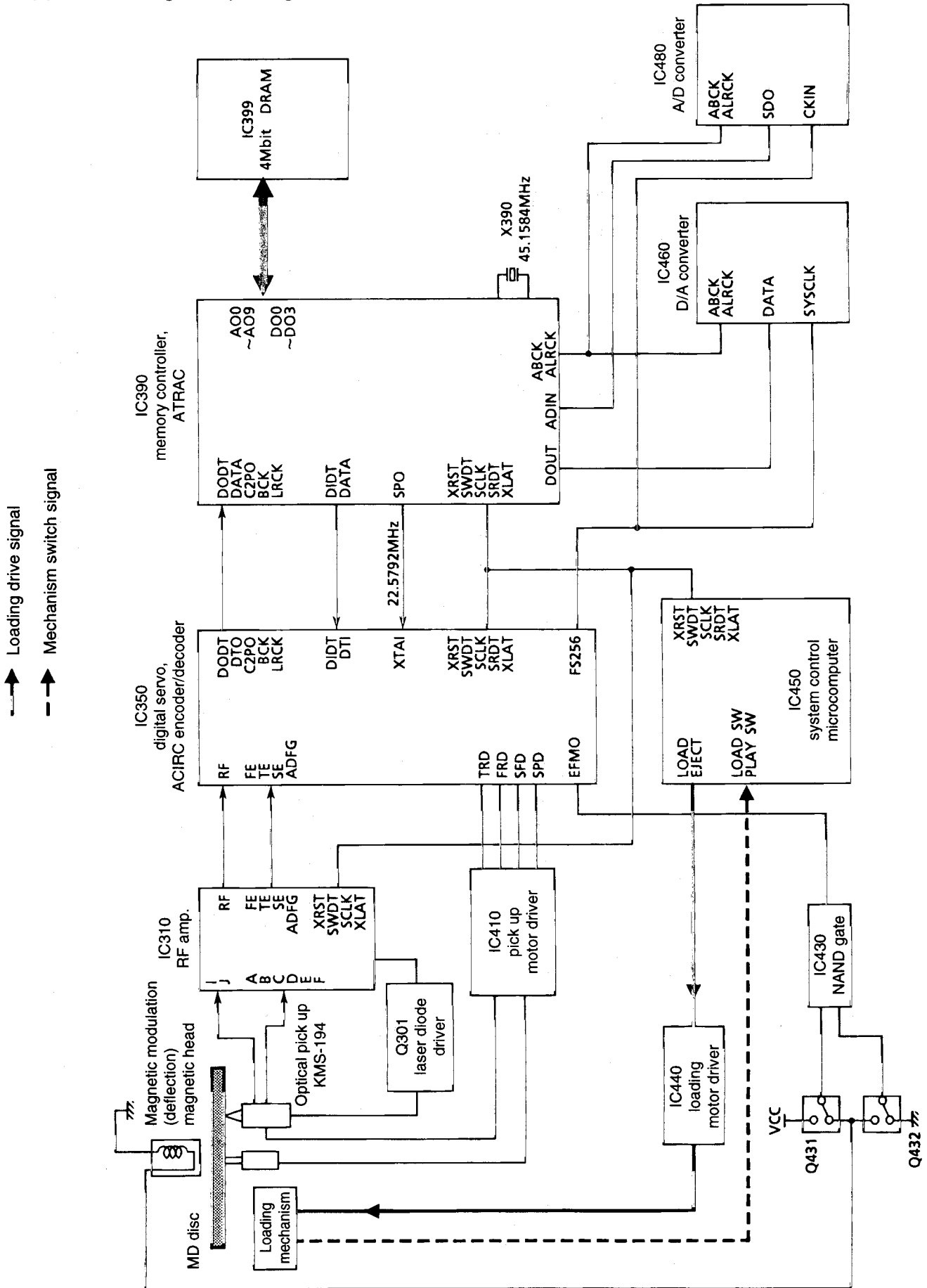

(5) Pick up laser power control signal

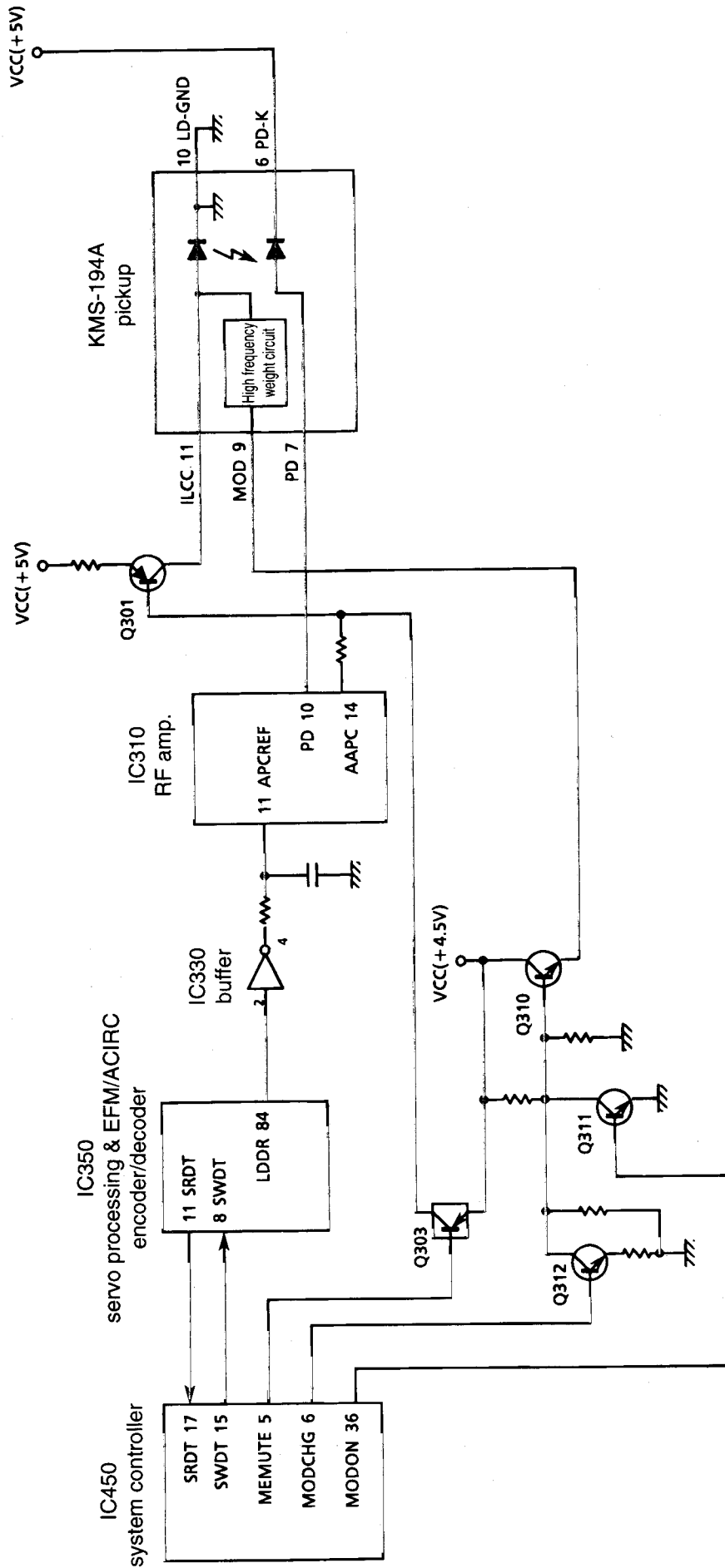

- (1) Adjust the laser power to 0.68mW with the REC. START and TRACK MARKING keys. - Playback laser power
- (2) Adjust the laser power to 6.23mW with the REC. START and TRACK MARKING keys. - Recording laser power

2-21-a

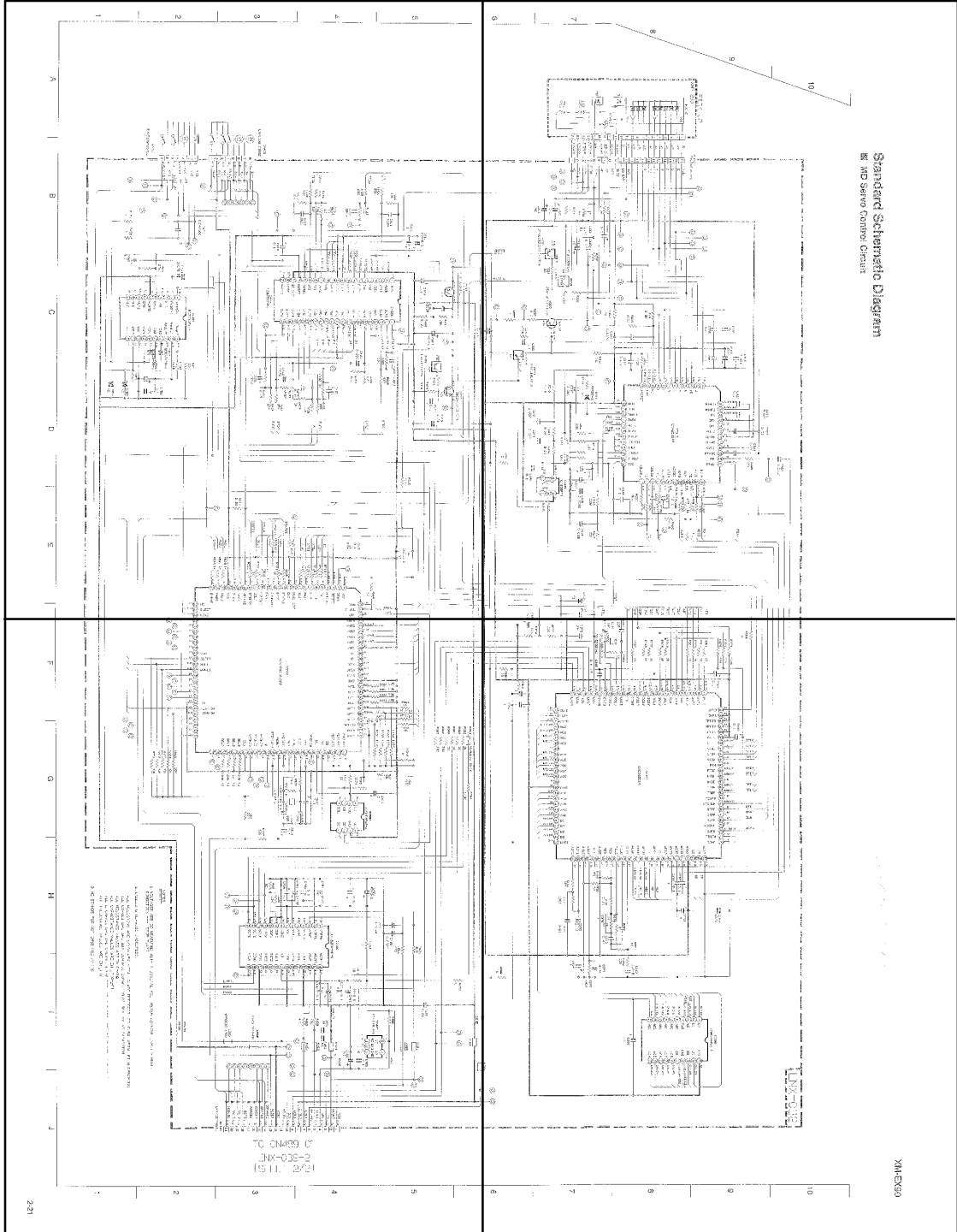

2-21-b

2-21-c

2-21-d

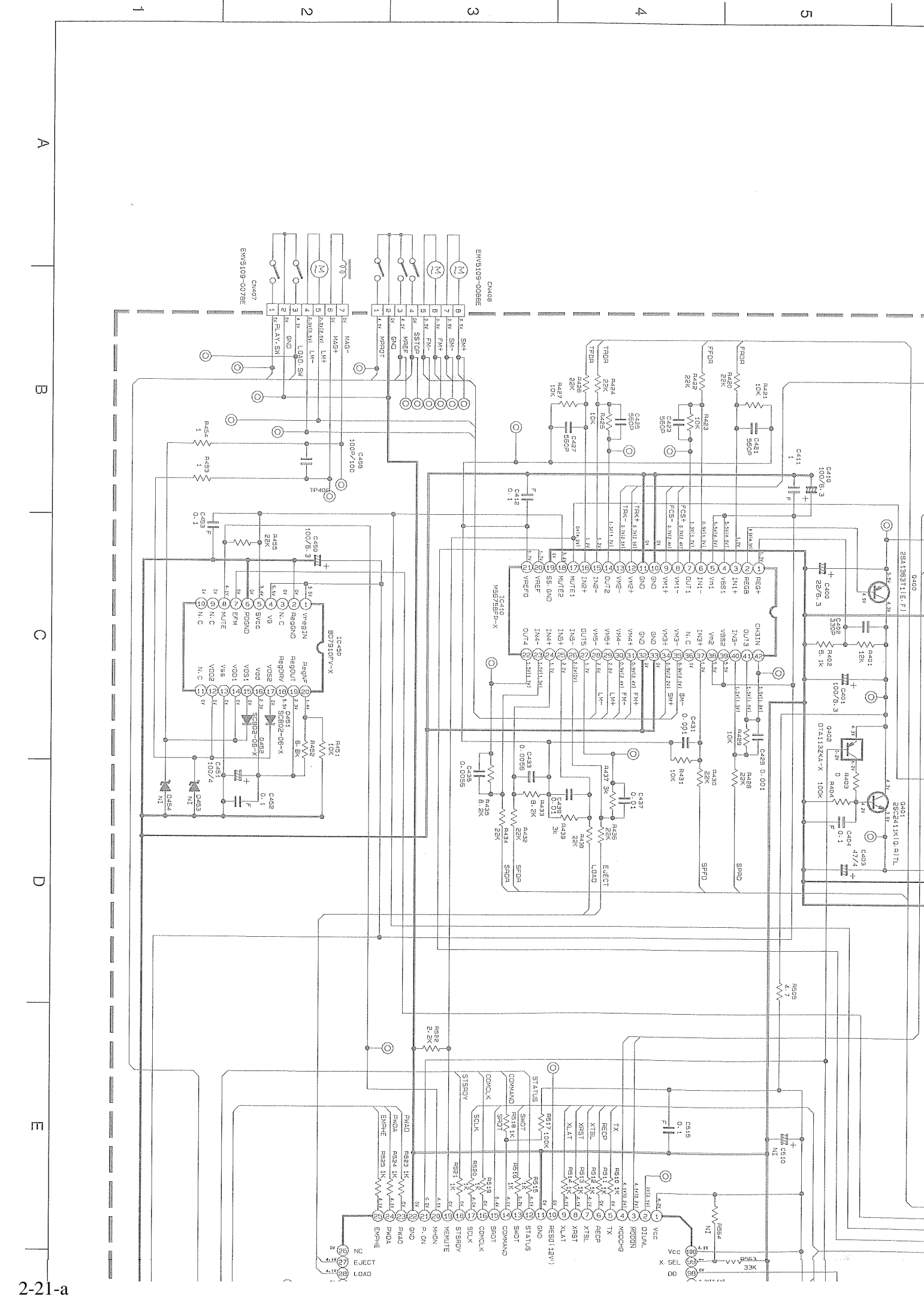

1  
2  
3  
4  
5

A  
B  
C  
D  
E



# Standard Schematic Diagram

## MD Servo Control Circuit

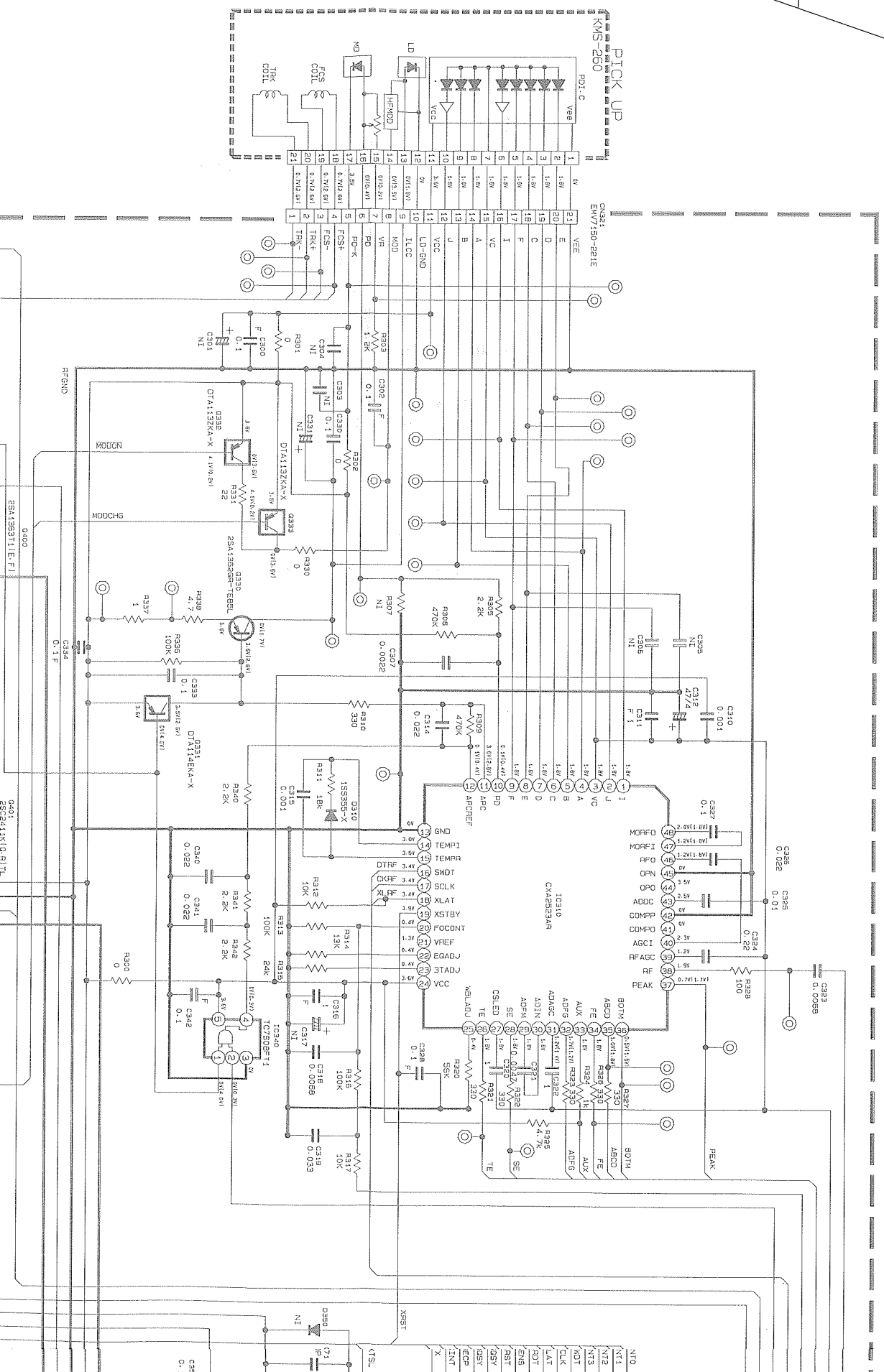

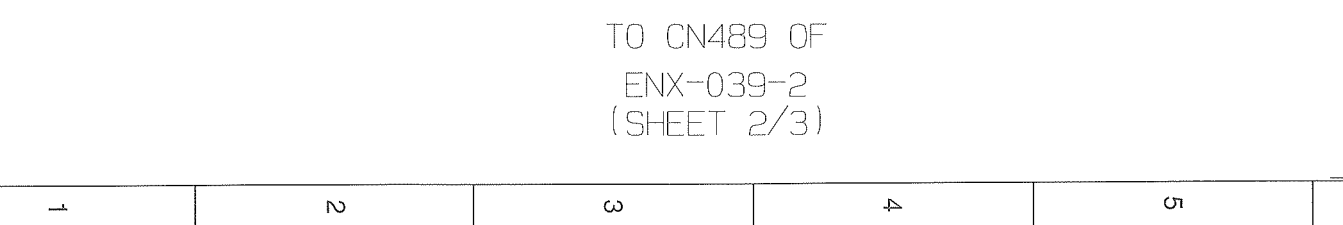
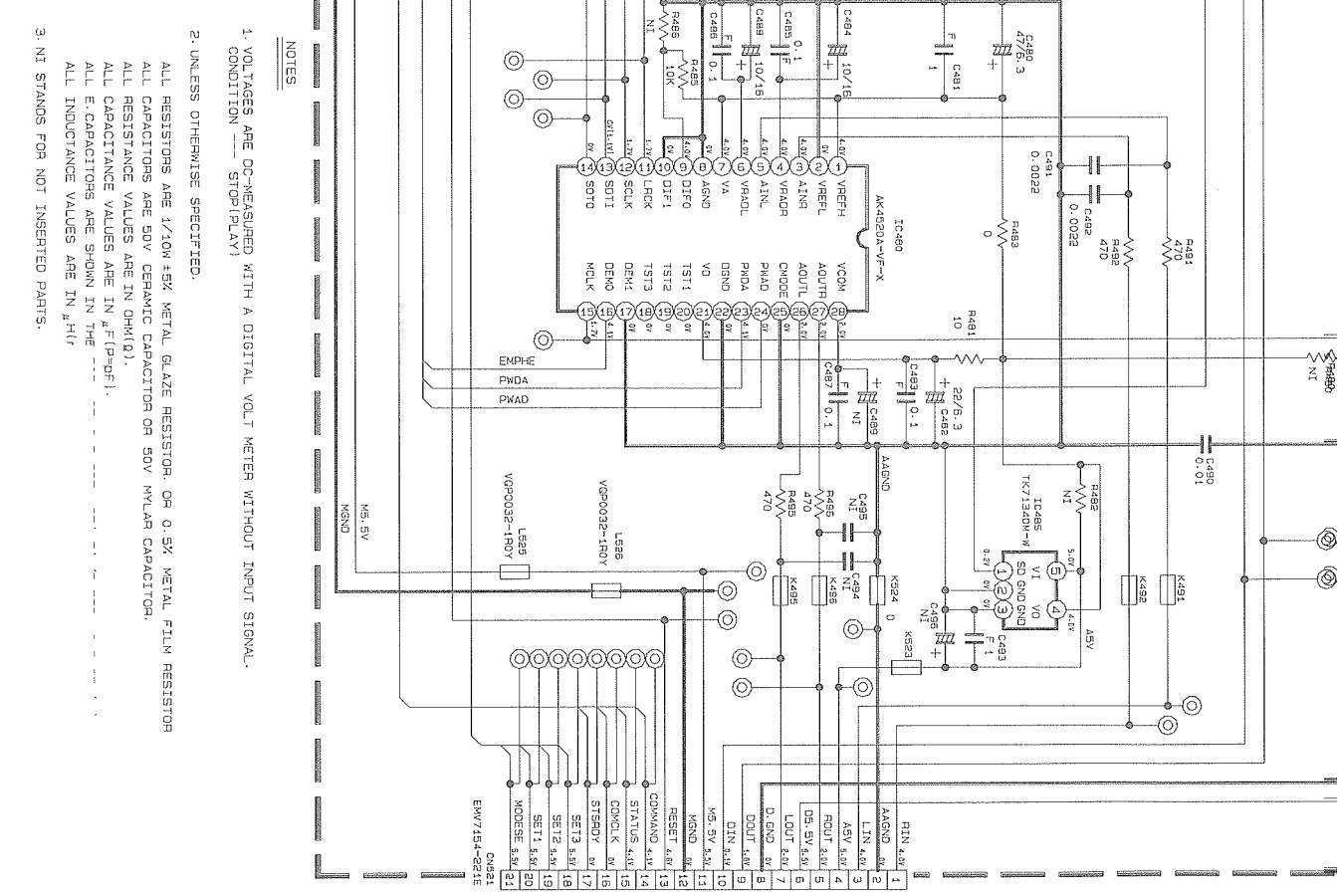
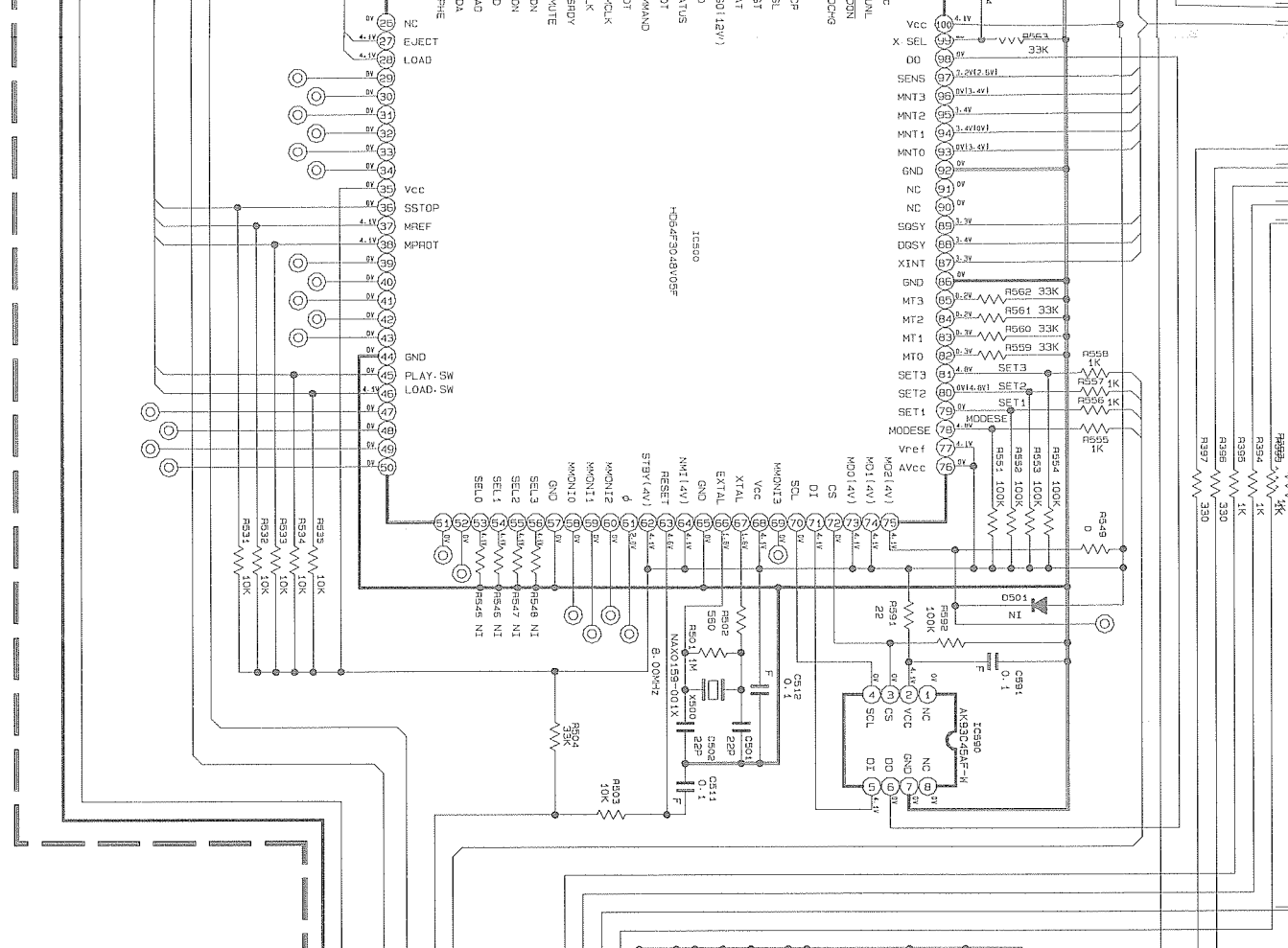

TO CN489 OF  
ENX-039-2  
(SHEET 2/3)

1. VOLTAGES ARE DC-MEASURED WITH A DIGITAL VOLT METER WITHOUT INPUT SIGNAL.  
CONDITION --- STOP(PLAY)

2. UNLESS OTHERWISE SPECIFIED.

ALL RESISTORS ARE 1/10W ±5% METAL GLAZE RESISTOR, OR 0.5X METAL FILM RESISTOR  
ALL CAPACITORS ARE 50V CERAMIC CAPACITOR OR 50V NYLON CAPACITOR.

ALL RESISTANCE VALUES ARE IN OHM(Ω).

ALL CAPACITANCE VALUES ARE IN μF (μ=10<sup>-6</sup>F).

ALL ELECTRIC CAPACITORS ARE SHOWN IN THE μF UNIT.  
ALL INDUCTANCE VALUES ARE IN μH UNIT.

3. NI STANDS FOR NOT INSERTED PARTS.

F G H I J

ENX-032

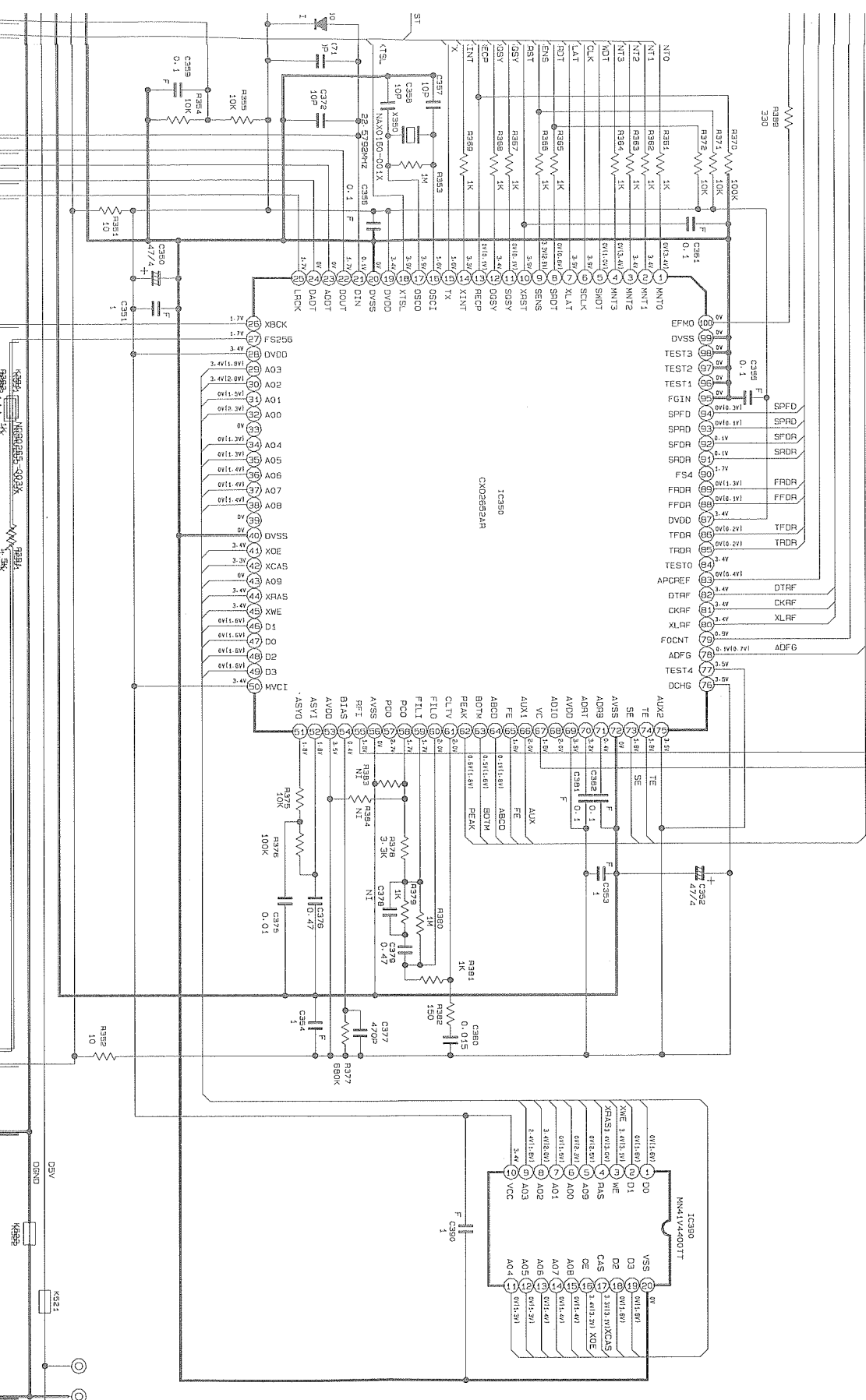

10

9

8

7

6



2-22-a

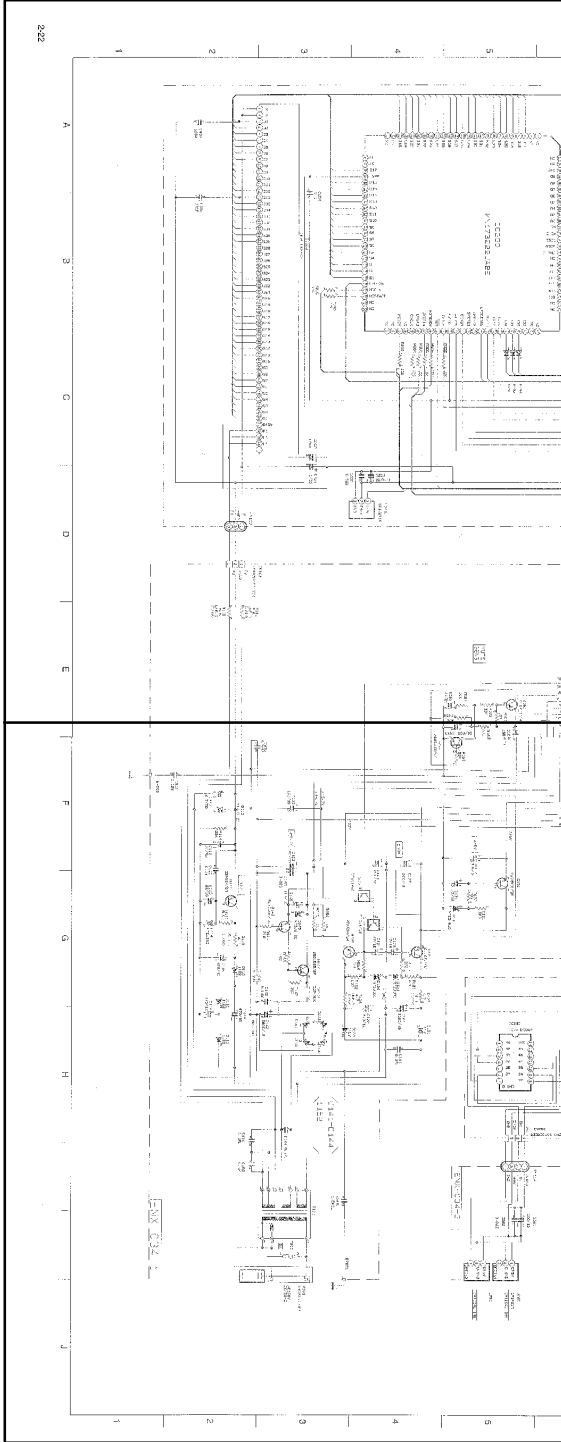

2-22-b

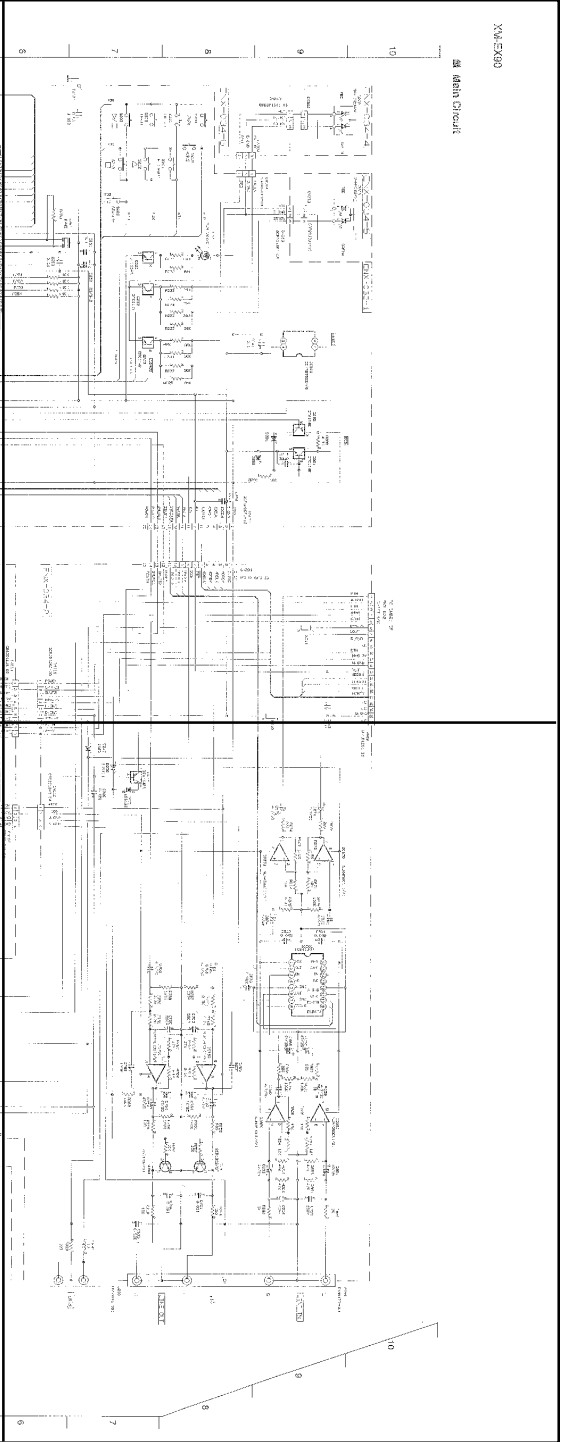

2-22-c



2-22-d



A

B

C

D

E

1

2

3

4

5

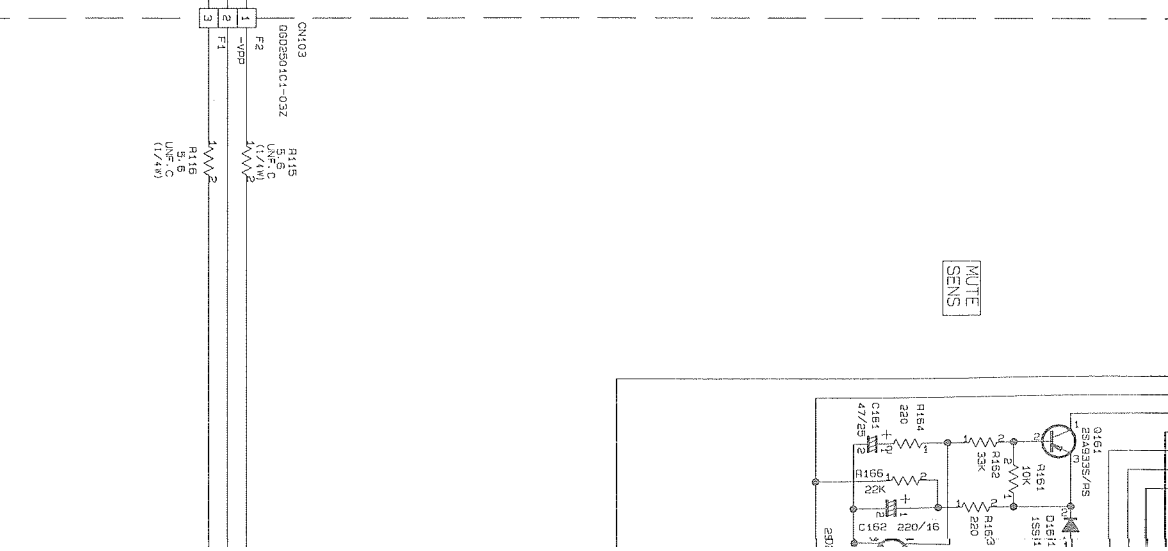
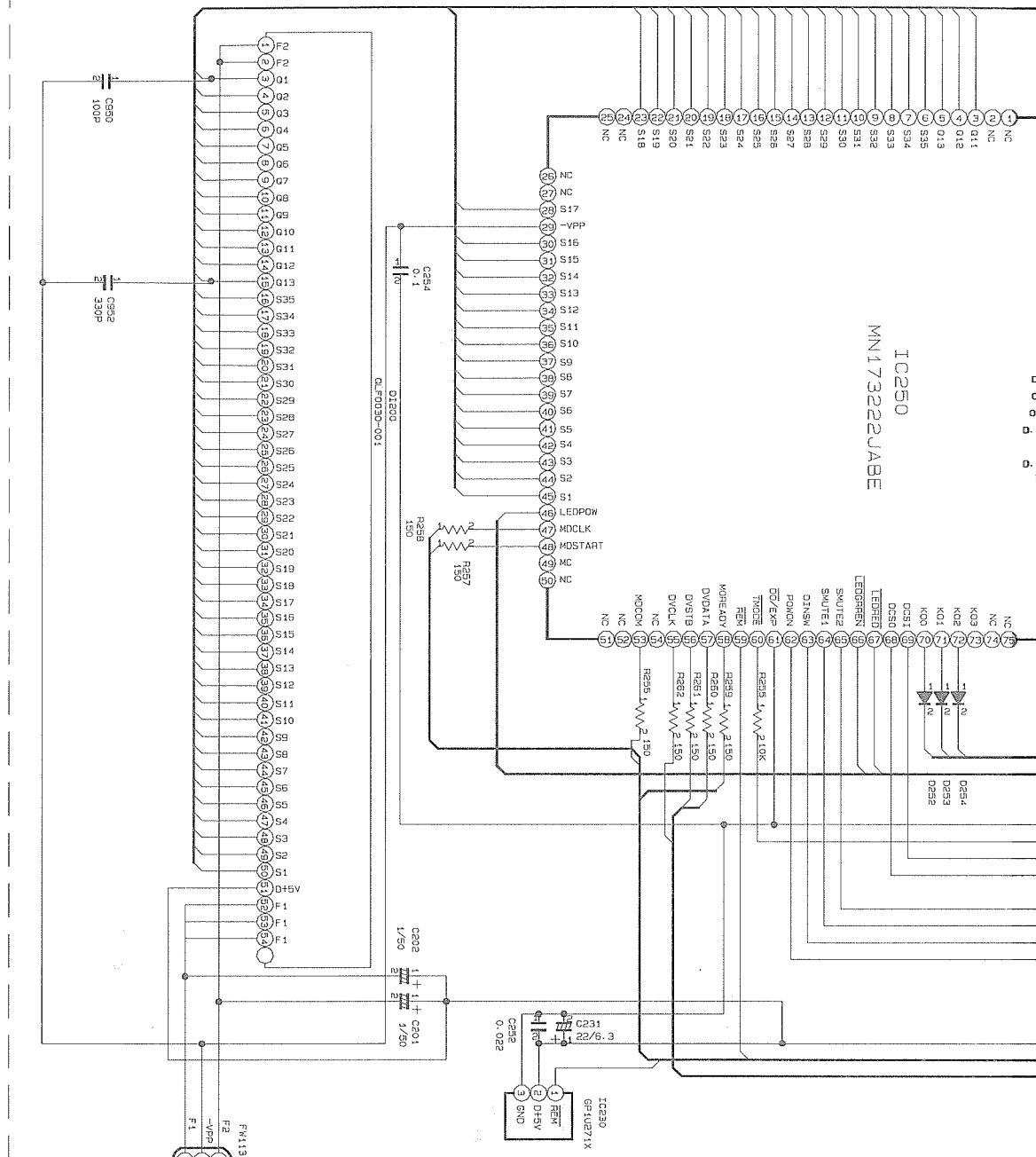

Main Circuit

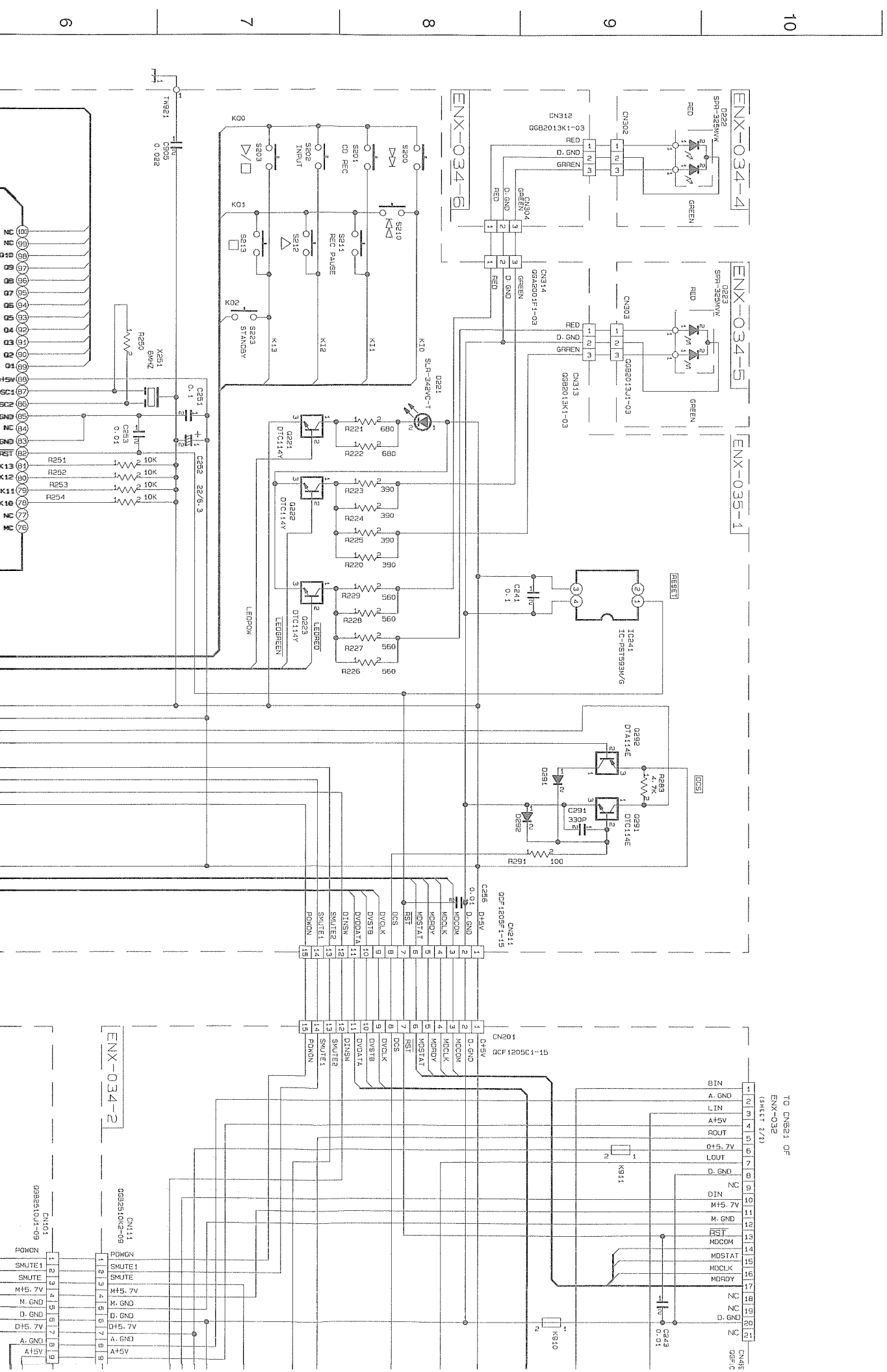

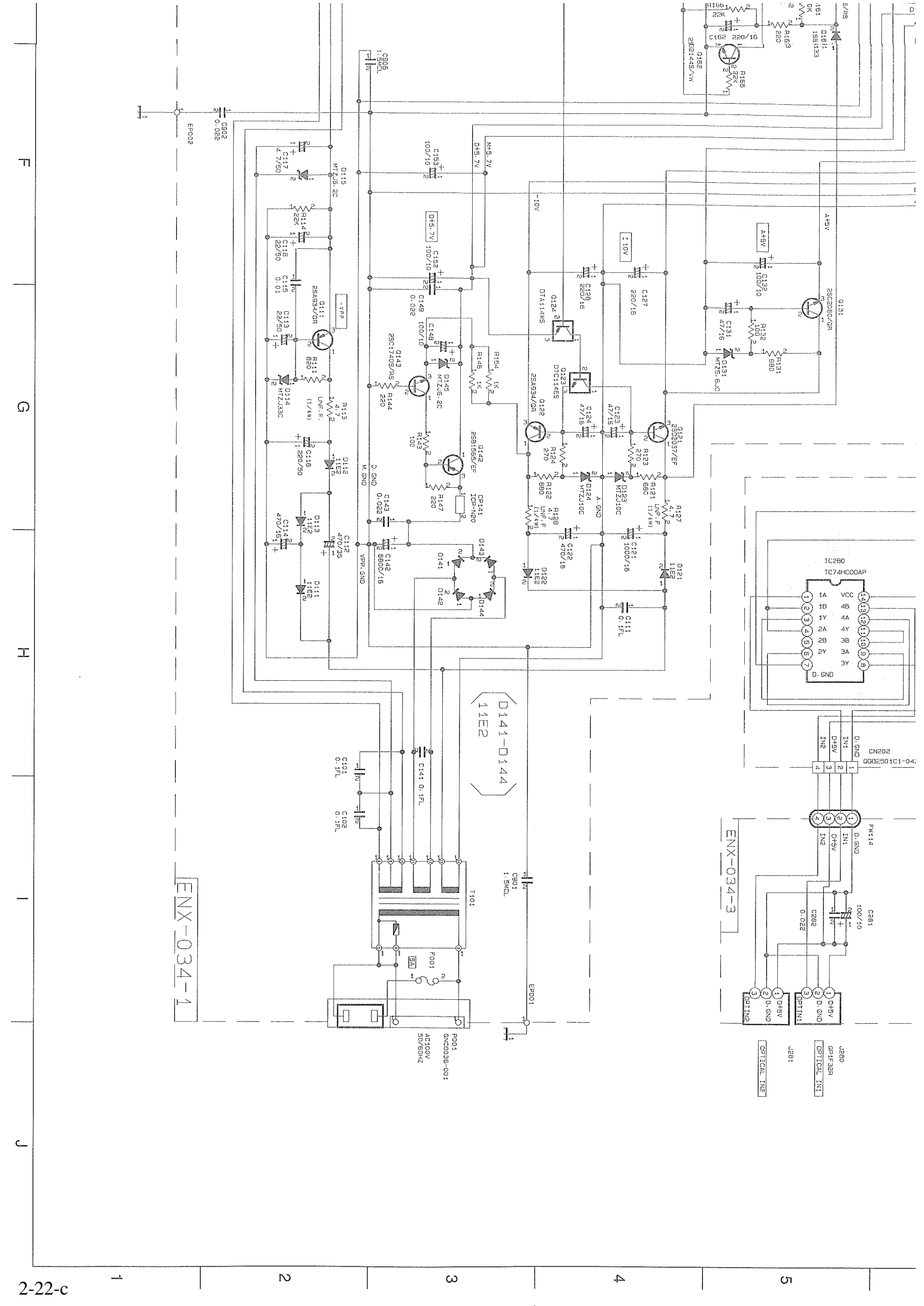







F

E

D

C

B

A

VERSION CODES

U : U.S.A.  
 C : CANADA  
 EN : NORDIC COUNTRIES  
 E : CONTINENTAL EUROPE  
 EE : EASTERN EUROPE  
 B : U.K.  
 UF : CHINA  
 UB : HONGKONG  
 US : SINGAPORE  
 UT : TAIWAN  
 U : UNIVERSAL EXCEPT ALL OF ABOVE

EXPLANATION OF OVERALL OF SCHEMA

MODEL XM-EX90

SHEET NO	CIRCUIT DESCRIPTION
1/3	PRIMARY REGULATOR
2/3	SECONDARY REGULATOR SYSTEM AND MECHA CONTROL KEY SW
3/3	SERVO FOR MD MECHA-DAY/AD LSI

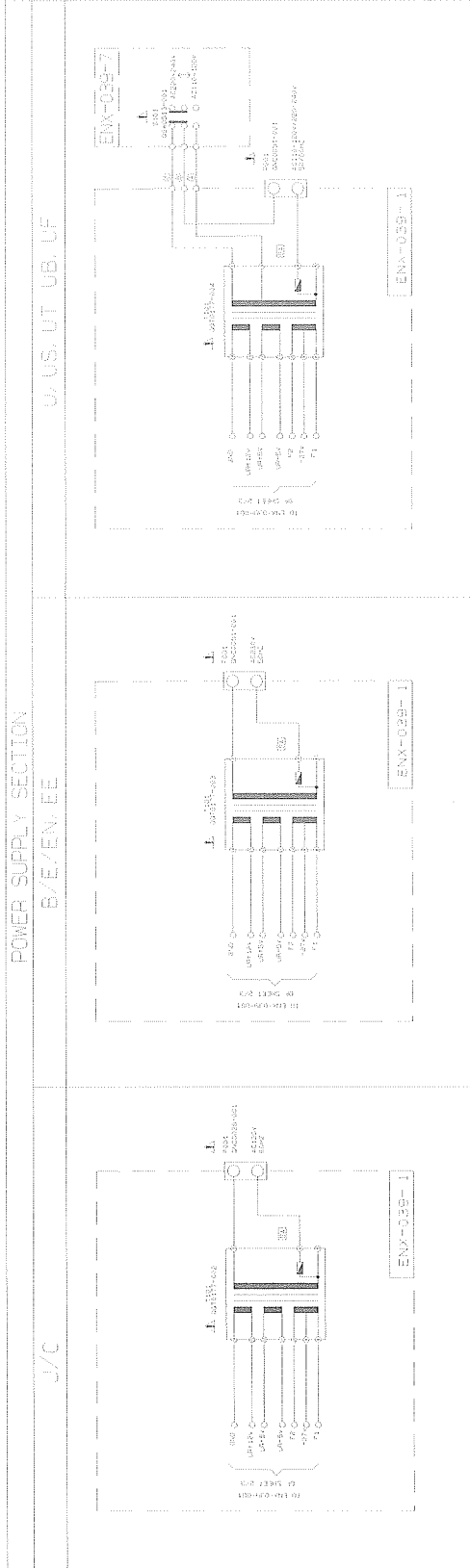

1

2

3

4

5

# Location of P.C. Board Parts

■ MD Mechanism board

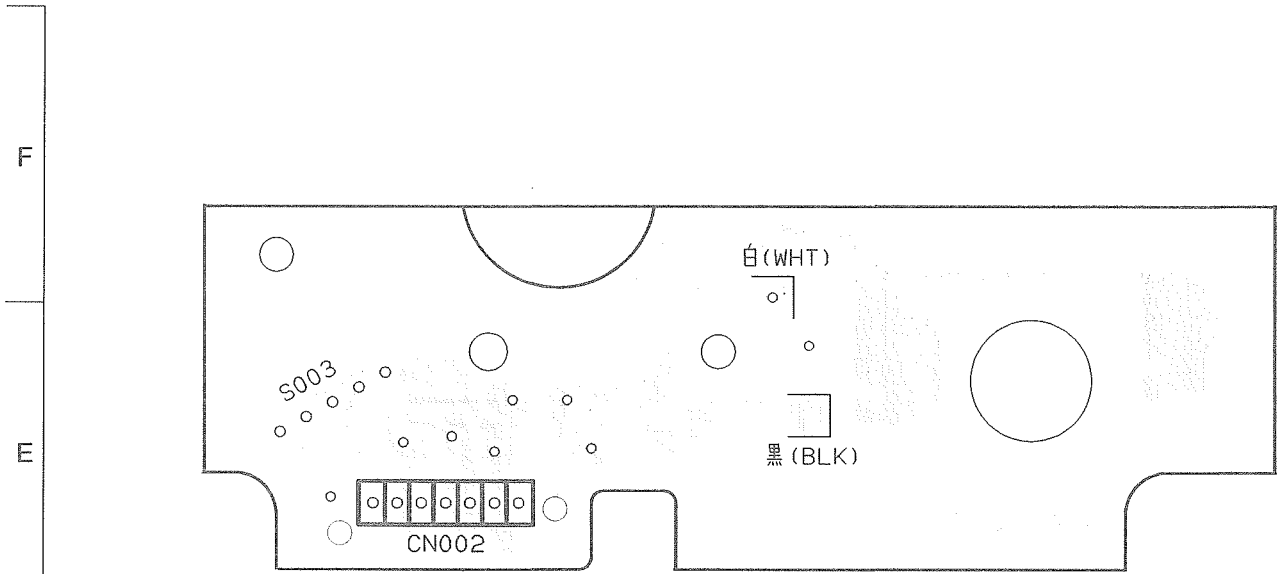

■ Switch Circuit board : Block No. 05

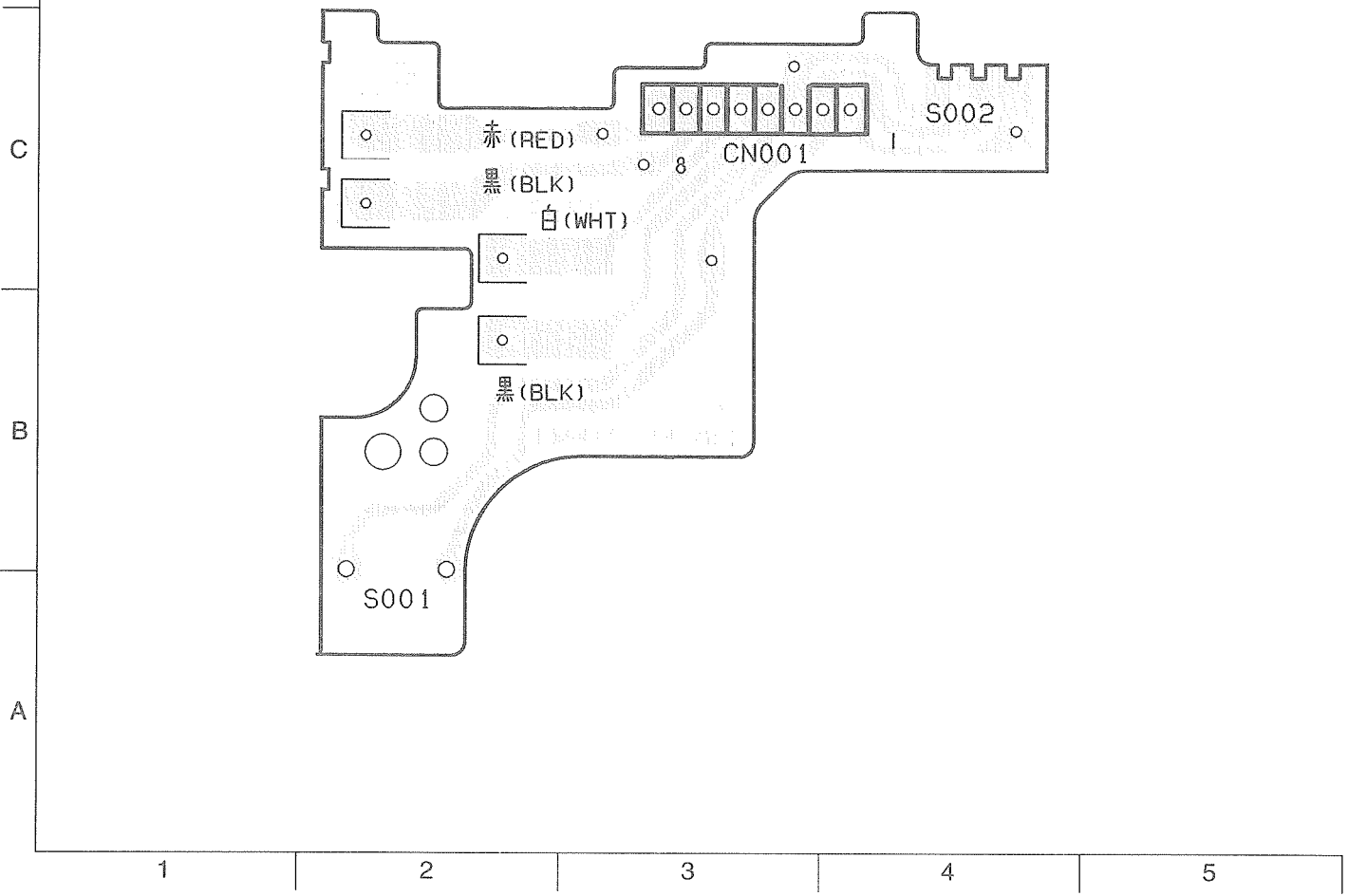





Solder View

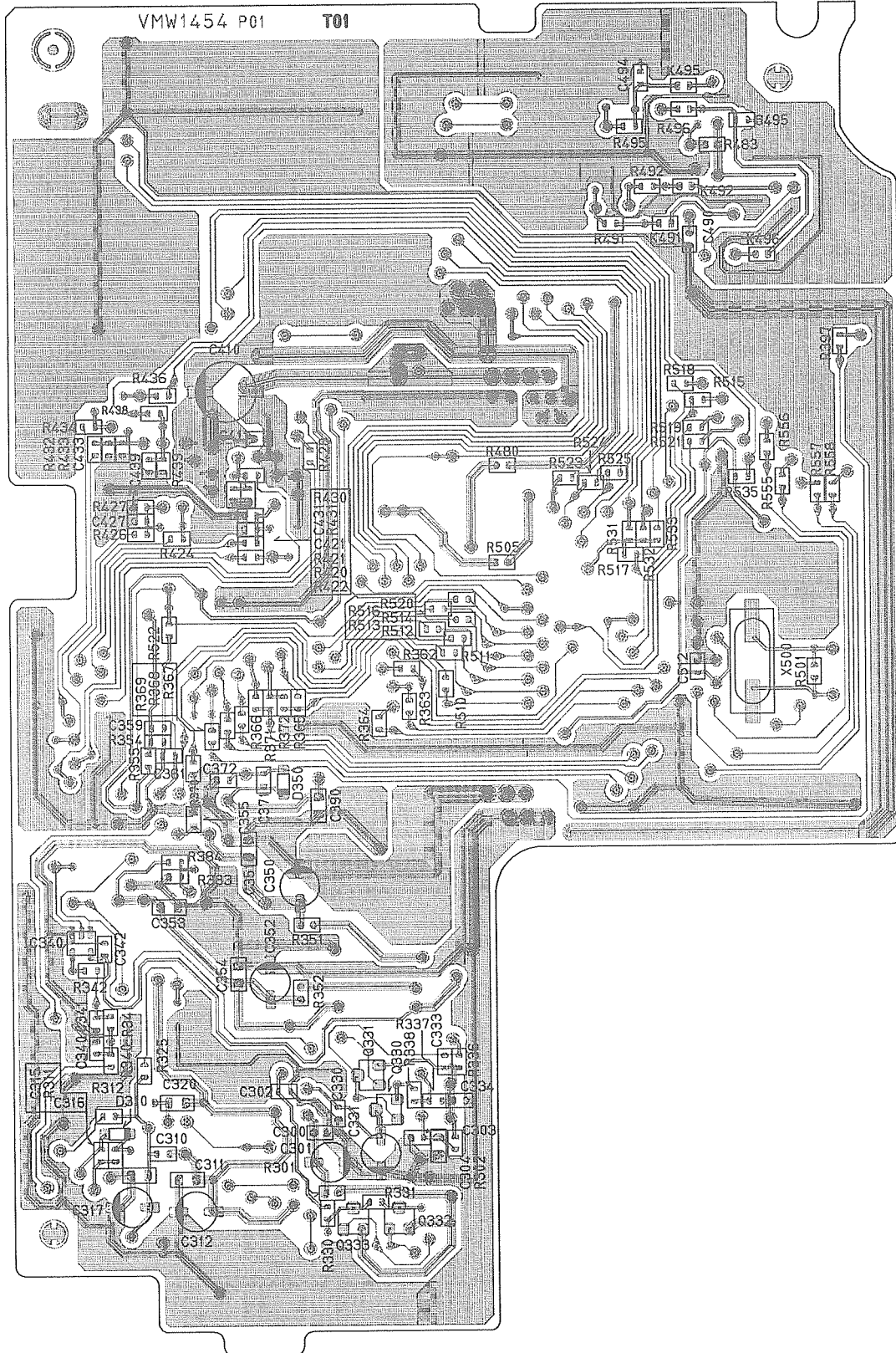

E F G H I

■ Main Board : Block No. 01

XM-EX90

XM-

■ Operation

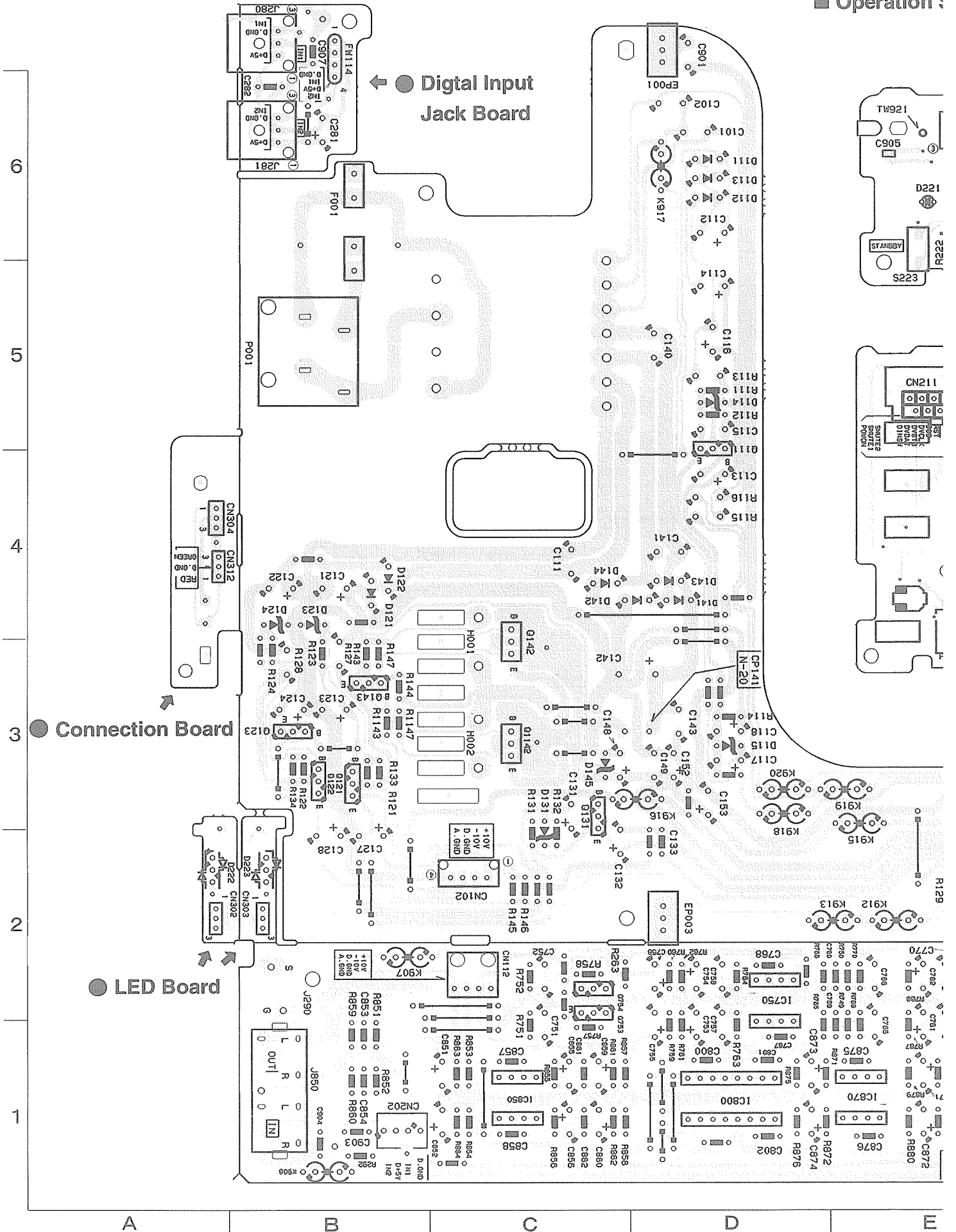







# PARTS LIST

[ XM-EX90 ]

1. Those parts can not to sent as a rule that has not printed or be displayed [—] on the parts list.
2. The printed circuit board will be not sent as a rule.
3.  Parts are safety assurance parts. When replacing those parts, make sure to use to specified one.
4. All printed circuit boards and its assemblies are not available as service parts.

Area Suffix	
B	U.K.
C	Canada
E	Continental Europe
J	U.S.A.
EE	Eastern Europe
EN	Northern Europe
UB	Hong Kong
UF	China
US	Singapore
UT	Taiwan
U	Other Areas

**- Contents -**

General Exploded View and Parts List .....	3- 2
MD Mechanism Ass'y and Parts List .....	3- 4
Electrical Parts List	
Main P.C.B. ....	3- 6
Front P.C.B. ....	3- 8
MD Servo Control P.C.B. ....	3- 9
Loading Circuit P.C.B. ....	3-11
Switch Circuit P.C.B. ....	3-11
Packing And Accessories List .....	3-12



Parts List

Block No. M1MM

△	Item	Parts Number	Parts Name	Q'ty	Description	Area
	1	LE20359-002A	FRONT PANEL	1		
	2	LE10163-002A	FRONT BASE	1		
	3	E406971-001SM	JVC MARK	1		
	4	LE30363-003A	WINDOW SCREEN	1		
	5	LE30550-002A	FL SCREEN	1		
	6	LE20361-003A	PUSH BUTTON	1		
	7	LE20363-002A	MD ESCUTCHEON	1		
	8	LE30565-001A	INDICATOR LENS	2		
	9	LE30566-001A	SHUTTER	1		
	10	LV40116-001A	SPRING	1		
	11	LE20365-001A	DISK GUIDE	1		
	12	QYSDSF2608Z	SCREW	11		
	13	VWF1215-18TTB	FLAT WIRE	1		
	14	PU49485-3	CORD CLAMP	1		
	15	E75896-001	SPACER	2		
	16	LE10164-001A	CHASSIS BASE	1		
	17	E47227-029	FOOT	2		
	18	QYSDSG3006N	T. SCREW	2		
	19	QYSBSG3008E	T. SCREW	7		
	20	VWF1021-12TTA	FLAT WIRE	1		
	21	QQT0177-002	POWER TRANSFORMER	1		C J
		QQT0177-003	POWER TRANSFORMER	1		B E EE EN
		QQT0177-004	POWER TRANSFORMER	1		U UB UF US UT
	22	QYSDSTL4008E	SPECIAL SCREW	2		
	23	QYSBSG2608M	T. SCREW	2		U UB UF US UT
	24	EWT025-006	TERMINAL WIRE	1		
	26	-----	MD MECHA UNIT	1		
	27	EWT025-003	TERMINAL WIRE	1		
	28	E406294-003	INSULATOR	4		
	29	LE20366-001A	SUB CHASSIS	1		
	30	LE30570-001A	GUIDE BRACKET	1		
	31	QYSDSG3006E	T. SCREW	3		
	32	LE20367-004A	REAR PANEL	1		J
		LE20367-005A	REAR PANEL	1		C
		LE20367-006A	REAR PANEL	1		U UB UF US
		LE20367-007A	REAR PANEL	1		UT
		LE20367-008A	REAR PANEL	1		B E EN
		LE20367-009A	REAR PANEL	1		EE
	33	QYSBSGY3008E	SPECIAL SCREW	7		
	35	LE20334-003A(S)	METAL COVER	1		
	36	LE30547-001A	PLAY CAP	1		C J
		LE30547-002A	POWER CAP	1		EXCEPT C J
	37	QYSBSGG3008E	T. SCREW	3		
	38	QYSDSG3006E	T. SCREW	5		
	39	E67000-027	CAUTION LABEL	1		
	40	QYSBST3006E	TAP. SCREW	3		
	41	EWT025-003	TERMINAL WIRE	1		EXCEPT C J

■ MD Mechanism Parts List

Block No. M2MM

△	Item	Parts Number	Parts Name	Q'ty	Description	Area
	1	E103156-002	LOADING BASE	1		
	2	MSN5G543C	LOADING MOTOR	1		
	3	E75984-222SS	MOTOR PULLEY	1		
	4	E409146-001	LOADING GEAR	1		
	5	E409143-001	LOADING GEAR	1		
	6	E409142-002	LOADING GEAR	1		
	7	E75950-002	REEL BELT	1		
	8	E409144-001	LOADING GEAR	1		
	9	E409145-001	LOADING GEAR	1		
	10	QYSPST2604Z	SCREW	2		
	11	E409149-002	SWITCH LEVER	1		
	12	QYSBSF2606M	SCREW	1		
	13	E309825-010	MECHA PLATE	1		
	14	QYSBSFG2606Z	TAPPING SCREW	3		
	15	QUB220-10DMDM	TERMINAL WIRE	1		
	17	E208853-001	RACK GEAR	1		
	18	E409153-002	SPRING	2		
	19	E409152-002	HOOK LEVER	1		
	20	E409195-002	RACK GEAR	1		
	21	E309824-001	LINK LEVER	1		
	22	E409154-002	HOOK LEVER	1		
	24	E309829-003	SLIDE BRACKET	1		
	25	E409163-001	SPECIAL SCREW	3		
	26	E409164-003	SLIDE BRACKET	1		
	27	QYSBST2606Z	TAPPING SCREW	1		
	28	LV40951-001A	MECHA BRACKET	2		
	29	E103258-001	MECHA BASE ASS'Y	1		
	30	QSW0508-001	PUSH SWITCH	1		
	31	QYSPSGT2035M	SCREW	1		
	32	E409553-001	WORM SHAFT	1		
	33	E409542-001	GEAR	1		
	34	E409548-001	THRUST PLATE	1		
	35	E409135-001	THRUST SPRING	1		
	36	E409332-001	SCREW	2		
	37	EWT025-008	TERMINAL WIRE	1		
	38	FF-110PH-08280S	SPINDLE MOTOR	1		
	39	QYSPSPU1720M	MINI SCREW	4		
	40	QYSPST2606Z	TAPPING SCREW	2		
	41	LE30470-001A	TURN TABLE A'SSY	1		
	43	E409129-005	MOTOR BRACKET	1		
	44	E409133-001	LOADING GEAR	1		
	45	QYSPSPU1420Z	SCREW	2		
	46	FF-N30VA-09210	DC MOTOR	1		
	47	E409550-001	CAM GEAR	1		
	48	QWE269-06BB	VINYL WIRE	1		
	49	QWE260-05BB	VINYL WIRE	1		
	50	E310179-001	JOINT BRACKET	1		
	51	LE30001-008A	SPACER	1		
	52	HMD-7B	HEAD MOUNT	1		
	53	E409158-004	SPRING	1		
	54	E409165-001	SPRING	1		
	55	KMS-260A	CD PICKUP	1		
	56	QYSPST1414Z	SCREW	2		
	57	E408255-003	HOLDER SPRING	1		
	58	E409141-001	GUIDE SHAFT	1		
	59	E409158-002	SPRING	1		
	60	E409158-003	SPRING	1		
	61	E409167-001	SPRING PIN	1		
	62	QYSBSF2606M	SCREW	2		
	63	EMW40008-001	FLAT WIRE	1		

# MD Mechanism Ass'y and Parts List

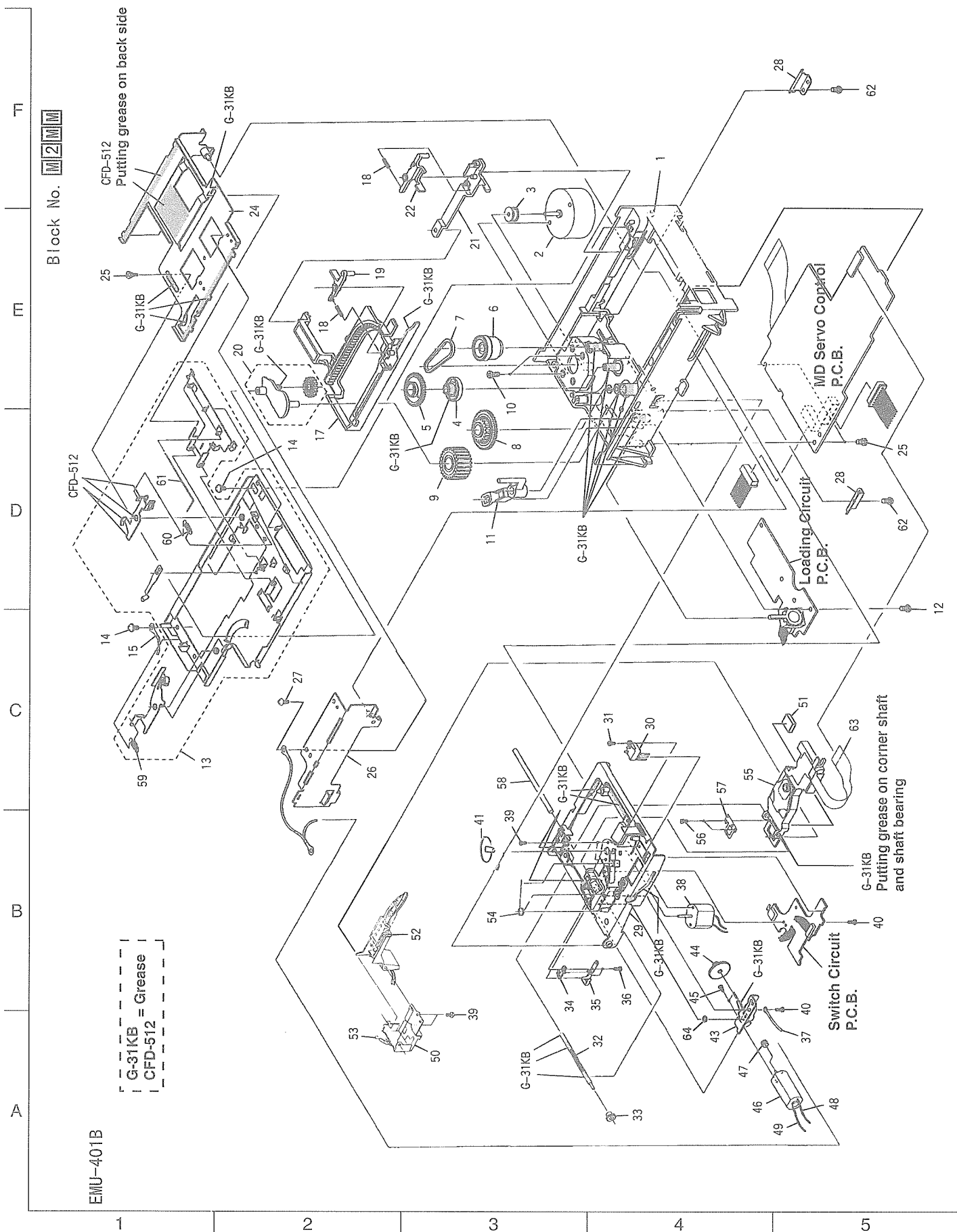

■Electrical Parts List(Main P.C.B.)

△	Item	Parts Number	Description	Area
		I. C. S		
	IC280	TC74HC00AP	I. C (DIGI-MOS)	
	IC750	NJM4580D	I. C (MONO-ANALOG)	
	IC800	TC9413AP	I. C (M)	
	IC850	NJM4580D	I. C (MONO-ANALOG)	
	IC870	NJM4580D	I. C (MONO-ANALOG)	
		DIODES		
	D111	11E2-T5	SILICON	
	D112	11E2-T5	SILICON	
	D113	11E2-T5	SILICON	
	D115	MTZJ6. 2C-T2	ZENER	
	D116	MTZJ33C-T2	ZENER	
	D121	11E2-T5	SILICON	
	D122	11E2-T5	SILICON	
	D123	MTZJ10C-T2	ZENER	
	D124	MTZJ10C-T2	ZENER	
	D131	MTZJ5. 6C-T2	ZENER	
	D141	11E2-T5	SILICON	
	D142	11E2-T5	SILICON	
	D143	11E2-T5	SILICON	
	D144	11E2-T5	SILICON	
	D145	MTZJ6. 2C-T2	ZENER	
	D161	1SS133-T2	SI. DIODE	
	D222	SPR-325MVW/L/-T	L. E. D.	
	D223	SPR-325MVW/L/-T	L. E. D.	
	D245	11E2-T5	SILICON	
	D255	1SS133-T2	SI. DIODE	
	D256	1SS133-T2	SI. DIODE	
		TRANSISTORS		
	Q111	2SA934/QR/-T	SILICON	
	Q121	2SD2037/EF/-T	SILICON	
	Q122	2SA934/QR/-T	SILICON	
	Q123	DT0114ES	DIGITAL TRANSISTOR	
	Q124	DTA114WS	DIGITAL TRANSISTOR	
	Q131	2SC2060/QR/-T	SILICON	
	Q142	2SB1565-EF/-	SILICON	
	Q143	2SC1740S/RS/-T	SI. TRANSISTOR	
	Q161	2SA933S/RS/-T	SILICON	
	Q162	2SD2144S/VW/-T	SILICON	
	Q251	DTA114ES	DIGITAL TRANSISTOR	
	Q753	2SD1302/ST/-T	SILICON	
	Q754	2SD1302/ST/-T	SILICON	
		CAPACITORS		
	C101	QFLB1HJ-104Z	0. 1MF 50V MYLAR CAP.	
	C102	QFLB1HJ-104Z	0. 1MF 50V MYLAR CAP.	
	C111	QFLB1HJ-104Z	0. 1MF 50V MYLAR CAP.	
	C112	QETB1VM-477Z	470MF 35V AL E. CAP.	
	C113	QETB1HM-226Z	22MF 50V E. CAP.	
	C114	QETB1CM-477Z	470MF 16V E. CAP.	
	C115	QCF31HZ-103Z	0. 01MF 50V CERAMIC	
	C116	QETB1HM-227Z	220MF 50V E. CAP.	
	C117	QTE1H28-475Z	E CAP.	
	C118	QETB1HM-226Z	22MF 50V E. CAP.	
△	C121	QETB1CM-108	1000MF 16V AL E. CAP.	
	C122	QETB1CM-477Z	470MF 16V E. CAP.	
	C123	QETB1CM-476Z	47MF 16V AL E. CAP.	
	C124	QETB1CM-476Z	47MF 16V AL E. CAP.	
	C127	QETC1CM-227Z	220MF 16V AL E. CAP.	
	C128	QETC1CM-227Z	220MF 16V AL E. CAP.	
	C131	QETB1CM-476Z	47MF 16V AL E. CAP.	
	C132	QETC1AM-107Z	100MF 10V E. CAP.	
	C141	QFLB1HJ-104Z	0. 1MF 50V MYLAR CAP.	
	C142	QETB1CM-688	6800MF 16V E. CAP.	
	C143	QCF31HZ-223Z	0. 022MF 50V CERAMIC	
	C148	QETC1AM-107Z	100MF 10V E. CAP.	
	C149	QCF31HZ-223Z	0. 022MF 50V CERAMIC	
	C152	QETC1AM-107Z	100MF 10V E. CAP.	
	C153	QETC1AM-107Z	100MF 10V E. CAP.	
	C161	QETB1EM-476Z	47MF 25V AL E. CAP.	
	C162	QETC1CM-227Z	220MF 16V AL E. CAP.	
	C243	QDYB1CM-103Y	0. 01MF 16V C CAP.	
	C281	QETC1AM-107Z	100MF 10V E. CAP.	
	C282	QDVB1EZ-223Y	0. 022MF 25V C CAP.	
	C751	QFN31HJ-102Z	1000PF 50V METAL. MYLAR	

△	Item	Parts Number	Description	Area
	C752	QFN31HJ-102Z	1000PF 50V METAL. MYLAR	
	C753	QTE1E28-476Z	E. CAPA. I. M	
	C754	QTE1E28-476Z	E. CAPA. I. M	
	C755	QTE1E28-476Z	E. CAPA. I. M	
	C756	QTE1E28-476Z	E. CAPA. I. M	
	C759	QCB1HK-561Y	560PF 50V CER. CAP.	
	C760	QCB1HK-561Y	560PF 50V CER. CAP.	
	C761	QTE1H28-475Z	E CAP.	
	C762	QTE1H28-475Z	E CAP.	
	C765	QFN31HJ-821Z	820PF 50V MYLAR CAP.	
	C766	QFN31HJ-821Z	820PF 50V MYLAR CAP.	
	C800	QDVB1EZ-223Y	0. 022MF 25V C CAP.	
	C801	QDVB1EZ-223Y	0. 022MF 25V C CAP.	
	C802	QDVB1EZ-223Y	0. 022MF 25V C CAP.	
	C851	QTE1E28-476Z	E. CAPA. I. M	
	C852	QTE1E28-476Z	E. CAPA. I. M	
	C853	QCB1HK-101Y	100PF 50V CER. CAP.	
	C854	QCB1HK-101Y	100PF 50V CER. CAP.	
	C855	QTE1E28-476Z	E. CAPA. I. M	
	C856	QTE1E28-476Z	E. CAPA. I. M	
	C859	QTE1H28-475Z	E CAP.	
	C860	QTE1H28-475Z	E CAP.	
	C871	QTE1H28-475Z	E CAP.	
	C872	QTE1H28-475Z	E CAP.	
	C873	QTE1E28-476Z	E. CAPA. I. M	
	C874	QTE1E28-476Z	E. CAPA. I. M	
	C901	QCZ0205-155Z	1. 5MF 25V C. CAP.	
	C902	QDVB1EZ-223Y	0. 022MF 25V C CAP.	
	C903	QDVB1EZ-223Y	0. 022MF 25V C CAP.	
	C906	QCZ0205-155Z	1. 5MF 25V C. CAP.	
	C920	QDVB1EZ-223Y	0. 022MF 25V C CAP.	
		RESISTORS		
	R111	QRJ146J-271X	270 1/4W R. NETWORK	
	R112	QRJ146J-271X	270 1/4W R. NETWORK	
	R113	QRJ146J-100X	10 1/4W R. NETWORK	J
		QRZ9005-100X	10 FUSIBLE	EXCEPT J
	R114	QRE141J-223Y	22K 1/4W R. NETWORK	
	R115	QRJ146J-3R3X	3. 3 1/4W R. NETWORK	
	R116	QRJ146J-3R3X	3. 3 1/4W R. NETWORK	
	R117	QRE141J-2R2Y	2. 2 1/4W R. NETWORK	
	R118	QRE141J-2R2Y	2. 2 1/4W R. NETWORK	
	R121	QRE141J-681Y	680 1/4W R. NETWORK	
	R122	QRE141J-681Y	680 1/4W R. NETWORK	
	R123	QRE141J-271Y	270 1/4W R. NETWORK	
	R124	QRE141J-271Y	270 1/4W R. NETWORK	
	R127	QRJ146J-4R7X	4. 7 1/4W R. NETWORK	J
		QRZ9006-4R7X	4. 7 FUSIBLE	EXCEPT J
	R128	QRJ146J-4R7X	4. 7 1/4W R. NETWORK	J
		QRZ9006-4R7X	4. 7 FUSIBLE	EXCEPT J
	R131	QRE141J-681Y	680 1/4W R. NETWORK	
	R132	QRE141J-181Y	180 1/4W R. NETWORK	
	R143	QRE141J-101Y	100 1/4W R. NETWORK	
	R144	QRE141J-221Y	220 1/4W R. NETWORK	
	R145	QRE141J-102Y	1K 1/4W R. NETWORK	
	R146	QRE141J-102Y	1K 1/4W R. NETWORK	
	R147	QRE141J-221Y	220 1/4W R. NETWORK	
	R161	QRE141J-103Y	10K 1/4W CARBON RES.	
	R162	QRE141J-333Y	33K 1/4W R. NETWORK	
	R163	QRE141J-221Y	220 1/4W R. NETWORK	
	R164	QRE141J-221Y	220 1/4W R. NETWORK	
	R165	QRE141J-223Y	22K 1/4W R. NETWORK	
	R166	QRE141J-223Y	22K 1/4W R. NETWORK	
	R263	QRE141J-154Y	150K 1/4W R. NETWORK	
	R292	QRE141J-101Y	100 1/4W R. NETWORK	
	R749	QRE141J-272Y	2. 7K 1/4W R. NETWORK	
	R750	QRE141J-272Y	2. 7K 1/4W R. NETWORK	
	R751	QRE141J-151Y	150 1/4W R. NETWORK	
	R752	QRE141J-151Y	150 1/4W R. NETWORK	
	R757	QRE141J-103Y	10K 1/4W CARBON RES.	
	R758	QRE141J-103Y	10K 1/4W CARBON RES.	
	R759	QRE141J-681Y	680 1/4W R. NETWORK	
	R760	QRE141J-681Y	680 1/4W R. NETWORK	
	R761	QRE141J-104Y	100K 1/4W R. NETWORK	
	R762	QRE141J-104Y	100K 1/4W R. NETWORK	



■Electrical Parts List(Main P.C.B.)

△	Item	Parts Number	Description	Area
	R763	QRE141J-912Y	9.1K 1/4W R. NETWORK	
	R764	QRE141J-912Y	9.1K 1/4W R. NETWORK	
	R765	QRE141J-273Y	27K 1/4W R. NETWORK	
	R766	QRE141J-273Y	27K 1/4W R. NETWORK	
	R767	QRE141J-104Y	100K 1/4W R. NETWORK	
	R768	QRE141J-104Y	100K 1/4W R. NETWORK	
	R769	QRE141J-272Y	2.7K 1/4W R. NETWORK	
	R770	QRE141J-272Y	2.7K 1/4W R. NETWORK	
	R851	QRE141J-473Y	47K 1/4W R. NETWORK	
	R852	QRE141J-473Y	47K 1/4W R. NETWORK	
	R853	QRE141J-123Y	12K 1/4W R. NETWORK	
	R854	QRE141J-123Y	12K 1/4W R. NETWORK	
	R855	QRE141J-153Y	15K 1/4W R. NETWORK	
	R856	QRE141J-153Y	15K 1/4W R. NETWORK	
	R857	QRE141J-221Y	220 1/4W R. NETWORK	
	R858	QRE141J-221Y	220 1/4W R. NETWORK	
	R859	QRE141J-302Y	3K 1/4W R. NETWORK	
	R860	QRE141J-302Y	3K 1/4W R. NETWORK	
	R861	QRE141J-104Y	100K 1/4W R. NETWORK	
	R862	QRE141J-104Y	100K 1/4W R. NETWORK	
	R863	QRE141J-473Y	47K 1/4W R. NETWORK	
	R864	QRE141J-473Y	47K 1/4W R. NETWORK	
	R871	QRE141J-103Y	10K 1/4W CARBON RES.	
	R872	QRE141J-103Y	10K 1/4W CARBON RES.	
	R873	QRE141J-221Y	220 1/4W R. NETWORK	
	R874	QRE141J-221Y	220 1/4W R. NETWORK	
	R875	QRE141J-104Y	100K 1/4W R. NETWORK	
	R876	QRE141J-104Y	100K 1/4W R. NETWORK	
	R879	QRE141J-182Y	1.8K 1/4W R. NETWORK	
	R880	QRE141J-182Y	1.8K 1/4W R. NETWORK	
		OTHERS		
		ENW10743-102	PRINTED BOARD	
		QWE881-13RR	VINYL WIRE	U UB UF US UT
		QWE882-12RR	VINYL WIRE	U UB UF US UT
		QWE883-11RR	VINYL WIRE	U UB UF US UT
		QYSBSG3008Z	T. SCREW	
	H001	E70945-H35	HEAT SINK	
	J280	GP1F32R	OPTICAL JACK	
	J281	GP1F32R	OPTICAL JACK	
	J290	QNS0016-001	3.5 JACK	
	J850	QNN0173-001	PIN JACK	
	K910	QGR0601-001Z	F. BEADS I.M	
	K911	QGR0601-001Z	F. BEADS I.M	
	K914	QGR0601-001Z	F. BEADS I.M	
	L291	QQL231K-1ROY	INDUCTOR I.M	
	P001	QNC0026-001	AC INLET	C J
		QNC0051-001	AC INLET	EXCEPT C J
	S101	QSW0513-001	SLIDE SW.	U UB UF US UT
	CN101	QGB2510J1-09	CONNECTOR	
	CN102	QGB2510J1-04	CONNECTOR	
	CN103	QGD2501C1-03Z	SOCKET I.M	
	CN111	QGB2510K2-09	CONNECTOR	
	CN112	QGB2510K2-04	CONNECTOR	
	CN201	QGF1205C1-15	CONNECTOR	
	CN202	QGD2501C1-04Z	SOCKET I.M	
	CN302	QGB2013J1-03	CONNECTER	
	CN303	QGB2013J1-03	CONNECTER	
	CN304	EWS263-F210	SOCKET WIRE ASSY	
	CN312	QGB2013K1-03	CONNECTER	
	CN489	QGF1016C1-21	CONNECTOR	
	CP141	ICP-N20-T	I. C. PROTECTOR	EXCEPT J
	CP901	ICP-N20-T	I. C. PROTECTOR	EXCEPT J
	CP902	ICP-N25-T	I. C. PROTECTOR	EXCEPT J
	CP903	ICP-N50-T	I. C. PROTECTOR	EXCEPT J
	EP001	QNZ0136-001Z	IM EARTH PLATE	
	EP002	QNZ0136-001Z	IM EARTH PLATE	
	FW114	EWR34B-06LST	FLAT WIRE ASSY	

# XM-EX90

## ■Electrical Parts List(Front P.C.B.)

△	Item	Parts Number	Description	Area
		I. C. S		
	IC230	GP1U271X	INFRARED DETECT UNIT	
	IC240	1C-PST593M/G/-X	I. C(M)	
	IC250	MN173222JABE1	I. C(M)	
		DIODES		
	D221	SLR-342VC-T	L. E. D.	
	D252	1SS355-X	SI. DIODE	
	D253	1SS355-X	SI. DIODE	
	D254	1SS355-X	SI. DIODE	
	D291	1SS355-X	SI. DIODE	
	D292	1SS355-X	SI. DIODE	
		TRANSISTORS		
	Q221	DTC114YKA-X	DIGITAL TRANSISTOR	
	Q222	DTA114YKA-X	DIGITAL TRANSISTOR	
	Q223	DTA114YKA-X	DIGITAL TRANSISTOR	
	Q291	DTC114EKA-X	DIGITAL TRANSISTOR	
	Q292	DTA114EKA-X	DIGITAL TRANSISTOR	
		CAPACITORS		
	C201	NEA21HM-105NZ	1MF 50V AL E. CAP.	
	C202	NEA21HM-105NZ	1MF 50V AL E. CAP.	
	C231	NEA20JM-226NZ	22MF 6.3V AL E. CAP.	
	C232	NCB31CK-223X	0.022MF 16V C CAP.	
	C241	NCB31CK-104X	0.1MF 16V C CAP.	
	C251	NCB31CK-104X	0.1MF 16V C CAP.	
	C252	NEA20JM-226NZ	22MF 6.3V AL E. CAP.	
	C253	NCB31CK-103X	0.01MF 16V C CAP.	
	C254	NCB31CK-104X	0.1MF 16V C CAP.	
	C256	NCB31CK-103X	0.01MF 16V C CAP.	
	C291	NCB31HK-331X	330PF 50V C CAP.	
	C905	NCB31CK-223X	0.022MF 16V C CAP.	
	C950	NCB31HK-101X	100PF 50V C CAP.	
	C962	NCB31HK-331X	330PF 50V C CAP.	
		RESISTORS		
	R220	NRSA63J-391X	MG RES.	
	R221	NRSA63J-681X	MG RES.	
	R222	NRSA63J-681X	MG RES.	
	R223	NRSA63J-391X	MG RES.	
	R224	NRSA63J-391X	MG RES.	
	R225	NRSA63J-391X	MG RES.	
	R226	NRSA63J-561X	MG RES.	
	R227	NRSA63J-561X	MG RES.	
	R228	NRSA63J-561X	MG RES.	
	R229	NRSA63J-561X	MG RES.	
	R251	NRSA63J-103X	MG RES.	
	R252	NRSA63J-103X	MG RES.	
	R253	NRSA63J-103X	MG RES.	
	R254	NRSA63J-103X	MG RES.	
	R255	NRSA63J-103X	MG RES.	
	R256	NRSA63J-151X	MG RES.	
	R257	NRSA63J-151X	MG RES.	
	R258	NRSA63J-151X	MG RES.	
	R259	NRSA63J-151X	MG RES.	
	R260	NRSA63J-151X	MG RES.	
	R261	NRSA63J-151X	MG RES.	
	R262	NRSA63J-151X	MG RES.	
	R263	NRSA63J-104X	MG RES.	
	R291	NRSA63J-101X	MG RES.	
	R293	NRSA63J-472X	MG RES.	
		OTHERS		
		EMW10744-003	PRINTED BOARD	
	S200	NSW0062-001X	TACT SWITCH	
	S201	NSW0062-001X	TACT SWITCH	
	S202	NSW0062-001X	TACT SWITCH	
	S203	NSW0062-001X	TACT SWITCH	
	S210	NSW0062-001X	TACT SWITCH	
	S211	NSW0062-001X	TACT SWITCH	
	S212	NSW0062-001X	TACT SWITCH	
	S213	NSW0062-001X	TACT SWITCH	
	S223	NSW0062-001X	TACT SWITCH	
	X251	NAX0192-001X	CRYSTAL	
	CN211	QGF1205F1-15	CONNECTOR	
	CN313	QGB2013K1-03	CONNECTOR	
	CN314	QGA2001F1-03	CONNECTOR	
	D1200	QLF0030-002	FLUORESCENT DISPLAY TUBE	

△	Item	Parts Number	Description	Area
	FH201	LE30640-001A	FL HOLDER	
	FH202	LE30640-002A	FL HOLDER	
	FS201	E3400-431	FELT SPACER	
	FS202	E3400-431	FELT SPACER	
	FW113	EWR33B-13LST	FLAT WIRE	
	TW921	EWT015-009	TERMINAL WIRE ASSY	

■Electrical Parts List(MD Servo Control P.C.B)

△	Item	Parts Number	Description	Area
		I. C. S		
	IC310	CXA2523AR	IC(M)	
	IC340	TC7S08FT1	IC(M)	
	IC350	CXD2652AR	IC(M)	
	IC390	MN41V4400TT	IC(M)	
	IC410	M56758FP-X	IC(M)	
	IC450	BD7910FV-X	IC(M)	
	IC480	AK4520A-VF-X	IC(M)	
	IC485	TK71340M-W	IC(M)	
	IC500	HD6433045SV06F	I. C.	
	IC590	AK93C45AF-W	IC(M)	
		DIODES		
	D310	1S355-X	SI DIODE	
	D451	SC802-06-X	DIODE	
	D452	SC802-06-X	DIODE	
		TRANSISTORS		
	Q330	2SA1362GR-TE85L	TRANSISTOR(SI)	
	Q331	DTA114EKA-X	DIGI. TRANSISTOR	
	Q332	DTA113ZKA-X	DIGI. TRANSISTOR	
	Q333	DTA113ZKA-X	DIGI. TRANSISTOR	
	Q400	2SA1363T1(E, F)	TRANSISTOR(SI)	
	Q401	2SC2411K(Q, R)TL	TRANSISTOR(SI)	
	Q402	DTA113ZKA-X	DIGI. TRANSISTOR	
		CAPACITORS		
	C300	NCF31CZ-104AY	0.1MF 16V CER. CAPACITOR	
	C302	NCF31CZ-104AY	0.1MF 16V CER. CAPACITOR	
	C307	NCB31HK-222AY	2200PF 50V CER. CAPACITOR	
	C310	NCB31HK-102AY	1000PF 50V CER. CAPACITOR	
	C311	NCF21CZ-105AY	1MF 16V CER. CAPACITOR	
	C312	NEA20GM-476NZ	47MF 4V AL. E. CAPACITOR	
	C314	NCB31CK-223A	0.022MF 16V CER. CAPACITOR	
	C315	NCB31HK-102AY	1000PF 50V CER. CAPACITOR	
	C316	NCF21CZ-105AY	1MF 16V CER. CAPACITOR	
	C318	NCB31HK-682AY	6800PF 50V CER. CAPACITOR	
	C319	NCB31CK-333AY	0.033MF 16V CER. CAPACITOR	
	C320	NCB20JK-105AY	1MF 6.3V CER. CAPACITOR	
	C321	NCB31HK-472AY	4700PF 50V CER. CAPACITOR	
	C322	NCB20JK-105AY	1MF 6.3V CER. CAPACITOR	
	C323	NCB31HK-682AY	6800PF 50V CER. CAPACITOR	
	C324	NCB21CK-224AYU	0.22MF 16V CER. CAPACITOR	
	C325	NCB31CK-103AYM	0.01MF 16V CER. CAPACITOR	
	C326	NCB31CK-223A	0.022MF 16V CER. CAPACITOR	
	C327	NCB31CK-104AY	0.1MF 16V CER. CAPACITOR	
	C328	NCB31CK-104AY	0.1MF 16V CER. CAPACITOR	
	C330	NCF31CZ-104AY	0.1MF 16V CER. CAPACITOR	
	C333	NCF31CZ-104AY	0.1MF 16V CER. CAPACITOR	
	C334	NCF31CZ-104AY	0.1MF 16V CER. CAPACITOR	
	C340	NCB31CK-223A	0.022MF 16V CER. CAPACITOR	
	C341	NCB31CK-223A	0.022MF 16V CER. CAPACITOR	
	C342	NCF31CZ-104AY	0.1MF 16V CER. CAPACITOR	
	C350	NEA20GM-476NZ	47MF 4V AL. E. CAPACITOR	
	C351	NCF21CZ-105AY	1MF 16V CER. CAPACITOR	
	C352	NEA20GM-476NZ	47MF 4V AL. E. CAPACITOR	
	C353	NCF21CZ-105AY	1MF 16V CER. CAPACITOR	
	C354	NCF21CZ-105AY	1MF 16V CER. CAPACITOR	
	C355	NCF31CZ-104AY	0.1MF 16V CER. CAPACITOR	
	C356	NCF31CZ-104AY	0.1MF 16V CER. CAPACITOR	
	C357	NCS21HJ-100AY	10PF 50V CER. CAPACITOR	
	C358	NCS21HJ-100AY	10PF 50V CER. CAPACITOR	
	C359	NCF31CZ-104AY	0.1MF 16V CER. CAPACITOR	
	C361	NCF31CZ-104AY	0.1MF 16V CER. CAPACITOR	
	C371	NCS31HJ-100AY	10PF 50V CER. CAPACITOR	
	C372	NCS31HJ-100AY	10PF 50V CER. CAPACITOR	
	C375	NCB31CK-103AYM	0.01MF 16V CER. CAPACITOR	
	C376	NCB21CK-474AY	0.47MF 16V CER. CAPACITOR	
	C377	NCS31HJ-471AY	470PF 50V CER. CAPACITOR	
	C379	NCB21CK-474AY	0.47MF 16V CER. CAPACITOR	
	C380	NCB31CK-153AYU	0.015MF 16V CER. CAPACITOR	
	C381	NCF31CZ-104AY	0.1MF 16V CER. CAPACITOR	
	C382	NCF31CZ-104AY	0.1MF 16V CER. CAPACITOR	
	C390	NCF21CZ-105AY	1MF 16V CER. CAPACITOR	

△	Item	Parts Number	Description	Area
	C400	NEA20JM-226NZ	22MF 6.3V AL. E. CAPACITOR	
	C401	NEA20JM-107NZM	100MF 6.3V AL. E. CAPACIT R	
	C402	NCB31HK-331AY	330PF 50V CER. CAPACITOR	
	C403	NEA20GM-476NZ	47MF 4V AL. E. CAPACITOR	
	C404	NCF31CZ-104AY	0.1MF 16V CER. CAPACITOR	
	C410	NEA20JM-107NZM	100MF 6.3V AL. E. CAPACITOR	
	C411	NCF31AZ-105AY	1MF 10V CER. CAPACITOR	
	C412	NCF31CZ-104AY	0.1MF 16V CER. CAPACITOR	
	C421	NCB31HK-561AY	560PF 50V CER. CAPACITOR	
	C423	NCB31HK-561AY	560PF 50V CER. CAPACITOR	
	C425	NCB31HK-561AY	560PF 50V CER. CAPACITOR	
	C427	NCB31HK-561AY	560PF 50V CER. CAPACITOR	
	C429	NCB31HK-102AY	1000PF 50V CER. CAPACITOR	
	C431	NCB31HK-102AY	1000PF 50V CER. CAPACITOR	
	C433	NCB31HK-562AYM	5600PF 50V CER. CAPACITOR	
	C435	NCB31HK-562AYM	5600PF 50V CER. CAPACITOR	
	C437	NCB31CK-103AYM	0.01MF 16V CER. CAPACITOR	
	C439	NCB31CK-103AYM	0.01MF 16V CER. CAPACITOR	
	C450	NEA20JM-107NZM	100MF 6.3V AL. E. CAPACITOR	
	C451	NEA20GM-107NZM	100MF AL. E. CAPACITOR	
	C452	NCF31CZ-104AY	0.1MF 16V CER. CAPACITOR	
	C453	NCF31CZ-104AY	0.1MF 16V CER. CAPACITOR	
	C455	NDC32AJ-101X	100PF 100V CAPACITOR	
	C480	NEA20JM-476NZ	47MF 6.3V AL. E. CAPACITOR	
	C481	NCF21CZ-105AY	1MF 16V CER. CAPACITOR	
	C482	NEA20JM-226NZ	22MF 6.3V AL. E. CAPACITOR	
	C483	NCF31CZ-104AY	0.1MF 16V CER. CAPACITOR	
	C484	NEA21CM-106NZ	10MF 16V AL. E. CAPACITOR	
	C485	NCF31CZ-104AY	0.1MF 16V CER. CAPACITOR	
	C486	NCF31CZ-104AY	0.1MF 16V CER. CAPACITOR	
	C487	NCF31CZ-104AY	0.1MF 16V CER. CAPACITOR	
	C488	NEA21CM-106NZ	10MF 16V AL. E. CAPACITOR	
	C490	NCB31CK-103AYM	0.01MF 16V CER. CAPACITOR	
	C491	NCB31HK-222AY	2200PF 50V CER. CAPACITOR	
	C492	NCB31HK-222AY	2200PF 50V CER. CAPACITOR	
	C493	NCF21CZ-105AY	1MF 16V CER. CAPACITOR	
	C501	NCS21HJ-220AY	22PF 50V CER. CAPACITOR	
	C502	NCS21HJ-220AY	22PF 50V CER. CAPACITOR	
	C511	NCF31CZ-104AY	0.1MF 16V CER. CAPACITOR	
	C512	NCF31CZ-104AY	0.1MF 16V CER. CAPACITOR	
	C515	NCF31CZ-104AY	0.1MF 16V CER. CAPACITOR	
	C591	NCF31CZ-104AY	0.1MF 16V CER. CAPACITOR	
		RESISTORS		
	R300	NRSA63J-0R0AY	M. G. RESISTOR	
	R301	NRSA63J-0R0AY	M. G. RESISTOR	
	R302	NRSA63J-0R0AY	M. G. RESISTOR	
	R303	NRSA63J-122NY	M. G. RESISTOR	
	R305	NRSA63J-222NY	M. G. RESISTOR	
	R306	NRSA63J-474NY	M. G. RESISTOR	
	R309	NRSA63J-474NY	M. G. RESISTOR	
	R310	NRSA63J-331NY	M. G. RESISTOR	
	R311	NRSA63J-183NY	M. G. RESISTOR	
	R312	NRSA63J-103N	M. G. RESISTOR	
	R313	NRSA63J-104NY	M. G. RESISTOR	
	R314	NRSA63J-133NY	M. G. RESISTOR	
	R315	NRSA63J-243NY	M. G. RESISTOR	
	R316	NRSA63J-104NY	M. G. RESISTOR	
	R317	NRSA63J-103N	M. G. RESISTOR	
	R320	NRSA63J-563NY	M. G. RESISTOR	
	R321	NRSA63J-331NY	M. G. RESISTOR	
	R322	NRSA63J-331NY	M. G. RESISTOR	
	R323	NRSA63J-331NY	M. G. RESISTOR	
	R324	NRSA63J-102NY	M. G. RESISTOR	
	R325	NRSA63J-472NY	M. G. RESISTOR	
	R326	NRSA63J-331NY	M. G. RESISTOR	
	R327	NRSA63J-331NY	M. G. RESISTOR	
	R328	NRSA63J-101NY	M. G. RESISTOR	
	R330	NRSA63J-0R0AY	M. G. RESISTOR	
	R331	NRSA63J-220NY	M. G. RESISTOR	
	R336	NRSA63J-104NY	M. G. RESISTOR	
	R337	NRSA63J-1R0NY	M. G. RESISTOR	

■Electrical Parts List(MD Servo Control P.C.B)

△	Item	Parts Number	Description	Area
	R338	NRSA63J-4R7NY	M. G. RESISTOR	
	R340	NRSA63J-222NY	M. G. RESISTOR	
	R341	NRSA63J-222NY	M. G. RESISTOR	
	R342	NRSA63J-222NY	M. G. RESISTOR	
	R351	NRSA63J-100NY	M. G. RESISTOR	
	R352	NRSA63J-100NY	M. G. RESISTOR	
	R353	NRSA63J-105NY	M. G. RESISTOR	
	R354	NRVA63D-103NY	C. M. F. RESISTOR	
	R355	NRVA63D-103NY	C. M. F. RESISTOR	
	R361	NRSA63J-102NY	M. G. RESISTOR	
	R362	NRSA63J-102NY	M. G. RESISTOR	
	R363	NRSA63J-102NY	M. G. RESISTOR	
	R364	NRSA63J-102NY	M. G. RESISTOR	
	R365	NRSA63J-102NY	M. G. RESISTOR	
	R366	NRSA63J-102NY	M. G. RESISTOR	
	R367	NRSA63J-102NY	M. G. RESISTOR	
	R368	NRSA63J-102NY	M. G. RESISTOR	
	R369	NRSA63J-102NY	M. G. RESISTOR	
	R370	NRSA63J-104NY	M. G. RESISTOR	
	R371	NRSA63J-103N	M. G. RESISTOR	
	R372	NRSA63J-103N	M. G. RESISTOR	
	R375	NRSA63J-103N	M. G. RESISTOR	
	R376	NRSA63J-104NY	M. G. RESISTOR	
	R377	NRSA63J-684NY	M. G. RESISTOR	
	R378	NRSA63J-332NY	M. G. RESISTOR	
	R379	NRSA63J-102NY	M. G. RESISTOR	
	R380	NRSA63J-105NY	M. G. RESISTOR	
	R381	NRSA63J-102NY	M. G. RESISTOR	
	R382	NRSA63J-151NY	M. G. RESISTOR	
	R389	NRSA63J-331NY	M. G. RESISTOR	
	R391	NRSA63J-331NY	M. G. RESISTOR	
	R392	NRSA63J-102NY	M. G. RESISTOR	
	R393	NRSA63J-102NY	M. G. RESISTOR	
	R394	NRSA63J-102NY	M. G. RESISTOR	
	R395	NRSA63J-102NY	M. G. RESISTOR	
	R396	NRSA63J-331NY	M. G. RESISTOR	
	R397	NRSA63J-331NY	M. G. RESISTOR	
	R401	NRVA63D-123X	C. M. F. RESISTOR	
	R402	NRVA63D-512X	C. M. F. RESISTOR	
	R403	NRSA63J-0R0AY	M. G. RESISTOR	
	R404	NRSA63J-104NY	M. G. RESISTOR	
	R420	NRVA63D-223NY	M. G. RESISTOR	
	R421	NRVA63D-103NY	C. M. F. RESISTOR	
	R422	NRVA63D-223NY	M. G. RESISTOR	
	R423	NRVA63D-103NY	C. M. F. RESISTOR	
	R424	NRVA63D-223NY	M. G. RESISTOR	
	R425	NRVA63D-103NY	C. M. F. RESISTOR	
	R426	NRVA63D-223NY	M. G. RESISTOR	
	R427	NRVA63D-103NY	C. M. F. RESISTOR	
	R428	NRVA63D-223NY	M. G. RESISTOR	
	R429	NRVA63D-103NY	C. M. F. RESISTOR	
	R430	NRVA63D-223NY	M. G. RESISTOR	
	R431	NRVA63D-103NY	C. M. F. RESISTOR	
	R432	NRVA63D-223NY	M. G. RESISTOR	
	R433	NRVA63D-822X	C. M. F. RESISTOR	
	R434	NRVA63D-223NY	M. G. RESISTOR	
	R435	NRVA63D-822X	C. M. F. RESISTOR	
	R436	NRSA63J-223NY	M. G. RESISTOR	
	R437	NRSA63J-302NY	M. G. RESISTOR	
	R438	NRSA63J-223NY	M. G. RESISTOR	
	R439	NRSA63J-302NY	M. G. RESISTOR	
	R451	NRSA63J-103N	M. G. RESISTOR	
	R452	NRSA63J-682NY	M. G. RESISTOR	
	R453	NRSA63J-1R0NY	M. G. RESISTOR	
	R454	NRSA63J-1R0NY	M. G. RESISTOR	
	R455	NRSA63J-223NY	M. G. RESISTOR	
	R481	NRSA63J-100NY	M. G. RESISTOR	
	R483	NRSA63J-0R0AY	M. G. RESISTOR	
	R485	NRSA63J-103N	M. G. RESISTOR	
	R491	NRSA63J-471NY	M. G. RESISTOR	
	R492	NRSA63J-471NY	M. G. RESISTOR	
	R495	NRSA63J-471NY	M. G. RESISTOR	

△	Item	Parts Number	Description	Area
	R496	NRSA63J-471NY	M. G. RESISTOR	
	R501	NRSA63J-105NY	M. G. RESISTOR	
	R502	NRSA63J-561NY	M. G. RESISTOR	
	R503	NRSA63J-103N	M. G. RESISTOR	
	R504	NRSA63J-333NY	M. G. RESISTOR	
	R505	NRSA63J-4R7NY	M. G. RESISTOR	
	R510	NRSA63J-102NY	M. G. RESISTOR	
	R511	NRSA63J-102NY	M. G. RESISTOR	
	R512	NRSA63J-102NY	M. G. RESISTOR	
	R513	NRSA63J-102NY	M. G. RESISTOR	
	R514	NRSA63J-102NY	M. G. RESISTOR	
	R515	NRSA63J-102NY	M. G. RESISTOR	
	R516	NRSA63J-102NY	M. G. RESISTOR	
	R517	NRSA63J-104NY	M. G. RESISTOR	
	R518	NRSA63J-102NY	M. G. RESISTOR	
	R519	NRSA63J-102NY	M. G. RESISTOR	
	R520	NRSA63J-102NY	M. G. RESISTOR	
	R521	NRSA63J-102NY	M. G. RESISTOR	
	R522	NRSA63J-222NY	M. G. RESISTOR	
	R523	NRSA63J-102NY	M. G. RESISTOR	
	R524	NRSA63J-102NY	M. G. RESISTOR	
	R525	NRSA63J-102NY	M. G. RESISTOR	
	R531	NRSA63J-103N	M. G. RESISTOR	
	R532	NRSA63J-103N	M. G. RESISTOR	
	R533	NRSA63J-103N	M. G. RESISTOR	
	R534	NRSA63J-103N	M. G. RESISTOR	
	R535	NRSA63J-103N	M. G. RESISTOR	
	R549	NRSA63J-0R0AY	M. G. RESISTOR	
	R551	NRSA63J-104NY	M. G. RESISTOR	
	R552	NRSA63J-104NY	M. G. RESISTOR	
	R553	NRSA63J-104NY	M. G. RESISTOR	
	R554	NRSA63J-104NY	M. G. RESISTOR	
	R555	NRSA63J-102NY	M. G. RESISTOR	
	R556	NRSA63J-102NY	M. G. RESISTOR	
	R557	NRSA63J-102NY	M. G. RESISTOR	
	R558	NRSA63J-102NY	M. G. RESISTOR	
	R559	NRSA63J-333NY	M. G. RESISTOR	
	R560	NRSA63J-333NY	M. G. RESISTOR	
	R561	NRSA63J-333NY	M. G. RESISTOR	
	R562	NRSA63J-333NY	M. G. RESISTOR	
	R563	NRSA63J-333NY	M. G. RESISTOR	
	R591	NRSA63J-220NY	M. G. RESISTOR	
	R592	NRSA63J-104NY	M. G. RESISTOR	
		OTHERS		
	K391	NQR0265-003X	BANDPASS FILTER	
	K491	NQR0129-004X	BANDPASS FILTER	
	K492	NQR0129-004X	BANDPASS FILTER	
	K495	NQR0129-004X	BANDPASS FILTER	
	K496	NQR0129-004X	BANDPASS FILTER	
	K521	VQZ0108-006Y	INDUCTOR	
	K522	VQZ0108-006Y	INDUCTOR	
	K523	NQR0129-002X	BANDPASS FILTER	
	K524	NRSA63J-0R0AY	M. G. RESISTOR	
	L525	VQP0032-1R0Y	INDUCTOR	
	L526	VQP0032-1R0Y	INDUCTOR	
	X350	NAX0160-001X	CRYSTAL	
	X500	NAX0159-001X	CRYSTAL	
	CN321	EMV7150-221E	CONNECT TERMINAL	
	CN407	EMV5109-007BE	CONNECT TERMINAL	
	CN408	EMV5109-008BE	CONNECT TERMINAL	
	CN521	EMV7154-221E	CONNECT TERMINAL	

■Electrical Parts List(Loading Circuit P.C.B.)

△	Item	Parts Number	Description	Area
		OTHERS		
	S003	QSW0472-001	LEVER SWITCH	
	CN002	EWS267-F908	SOCKET WIRE ASS'Y	

■Electrical Parts List(Switch Circuit P.C.B.)

△	Item	Parts Number	Description	Area
		OTHERS		
	S001	QSW0104-001	PUSH SWITCH	
	CN001	EWS268-F911	SOCKET WIRE ASS'Y	

■ Accessories List

Block No. **M3MM**

△	Item	Parts Number	Parts Name	Q'ty	Description	Area
	1	LVT0097-001A	INSTRUCTION BOOK	1		J
		LVT0097-002A	INSTRUCTION BOOK	1		B
		LVT0097-003A	INSTRUCTION BOOK	1		C
		LVT0097-004A	INSTRUCTION BOOK	1		E EN
		LVT0097-005A	INSTRUCTION BOOK	1		EN
		LVT0097-006A	INSTRUCTION BOOK	1		EE
		LVT0097-007A	INSTRUCTION BOOK	1		U UB UF US UT
	2	LV30258-030A	UB SHEET (XMEX90	1		UB
	3	QMPP060-183-JD	POWER CORD	1		UB
		QMPS020-183-JC	POWER CORD	1		UF
		QMP1F00-183	POWER CORD	1		CJ
△		QMP39F0-183	POWER CORD	1		E EE EN U US
		QMP5520-183	POWER CORD	1		B
△		QMP7530-183	POWER CORD	1		UT
	4	EWP302-023	SIGNAL CORD	2		
	5	EWP805-001W	REMOTE WIRE	1		
	6	QAM0006-001	OPTICAL SIGNAL CORD ASSY	1		
		QAM0027-001	SIEMENS PLUG	1		UT
		QAM0060-001	SIEMENS PLUG	1		U US
	7	QPC02503510P	POLY BAG	1		
	8	E300196-172	POLY BAG	1	FOR PLUG	B UB
	9	BT-52002-1	WARRANTY CARD	1		C
		BT-54008-1	WARRANTY CARD	1		B E EN
		BT-59011-1	WARRANTY CARD	1		UF
		R03UPTT/2STS	DRY CELL	2		
	10	E43486-340B	SAFETY SHEET	1		B
	11	QPC02503510P	POLY BAG	1		
	12	RM-SEEX90MEU	WIRE-LESS REMOTE CONTROL	1		U UB UF US UT
		RM-SEEX90MRU	WIRE-LESS REMOTE CONTROL	1		B E EE EN
		RM-SEEX90MU	WIRE-LESS REMOTE CONTROL	1		C J
	13	BT-51006-1	REGISTER CARD	1		J
	14	BT-20044G	SAFETY SHEET	1		J

# Packing Materials and Accessories List

Block No. **M4MM**

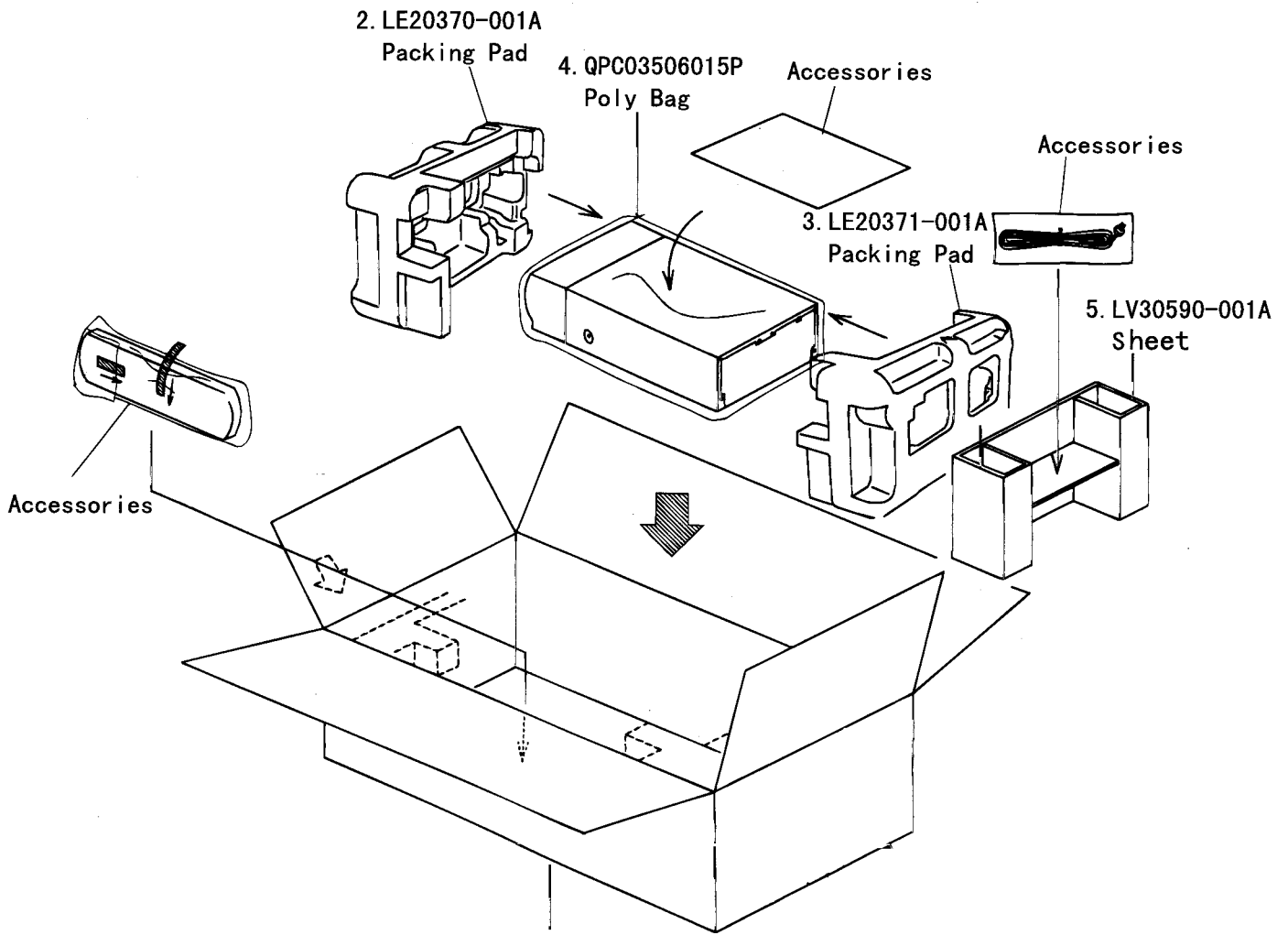

- 1. Packing Case
  - LV10063-001A (C/J)
  - LV10063-002A (E/EE/EN
  - U/UF/US/UT)
  - LV10064-001A (B/UB)

**XM-EX90**

**JVC**

VICTOR COMPANY OF JAPAN, LIMITED

AUDIO DIVISION, 10-1, 1Chome, Ohwatari-machi, Maebashi-city, 371-8543, Japan

(No.20709)

 Printed in Japan  
9807 (O)